

Caroline 2
Art. Nr. 4022299
1/12

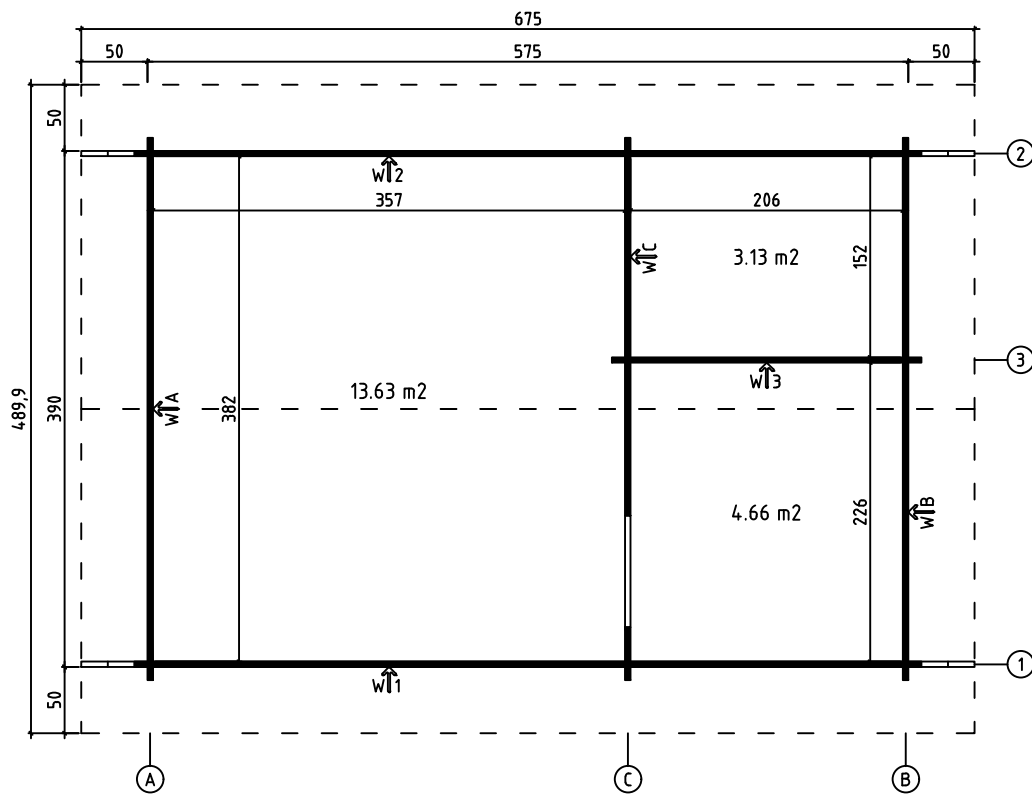

Art. Nr. 4022299

Groundplan - Grundplan - Plan de
masse - Planimetria - Plattegrond -
Põhiplan



First floor plan - Grundplan für erste stock - Plan du premier etage

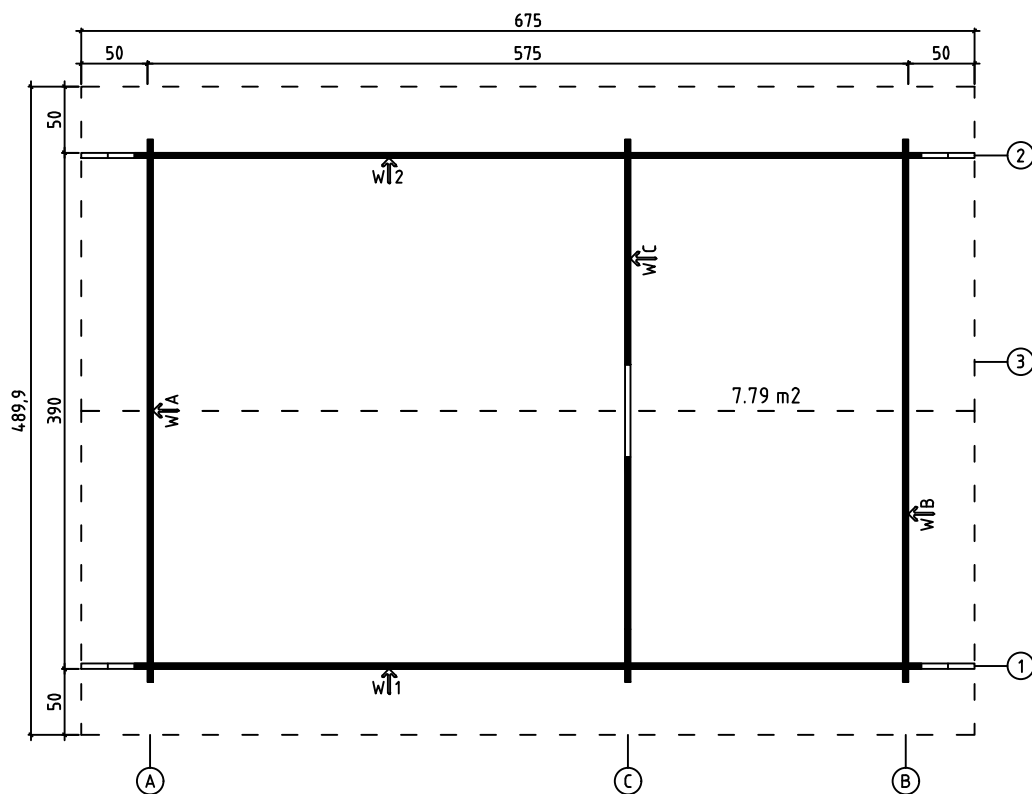

Art. Nr. 4022299

Foundation - Fundament - Fondation
- Fundamenta - Fundering -
Immutatud alusraam

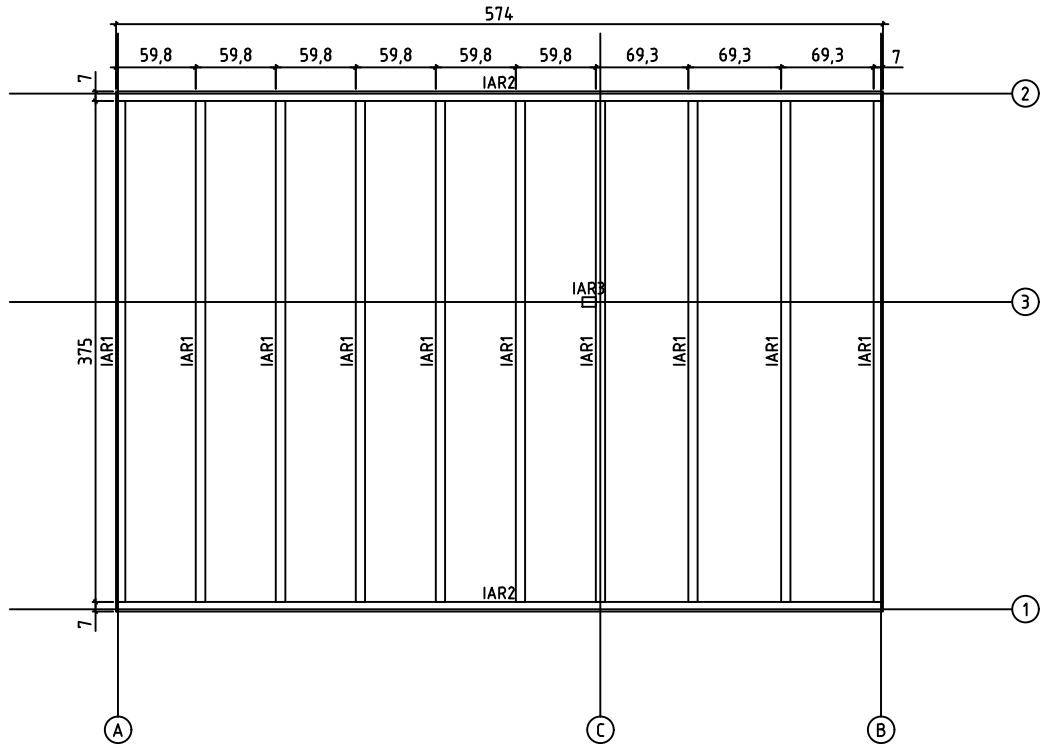

Mezzanine floor joists - Halbgeschoss balken -
Solives de plancher mezzanine - Travi del pavimento mezzanino -
Plaatduim scharnier - Laetlad

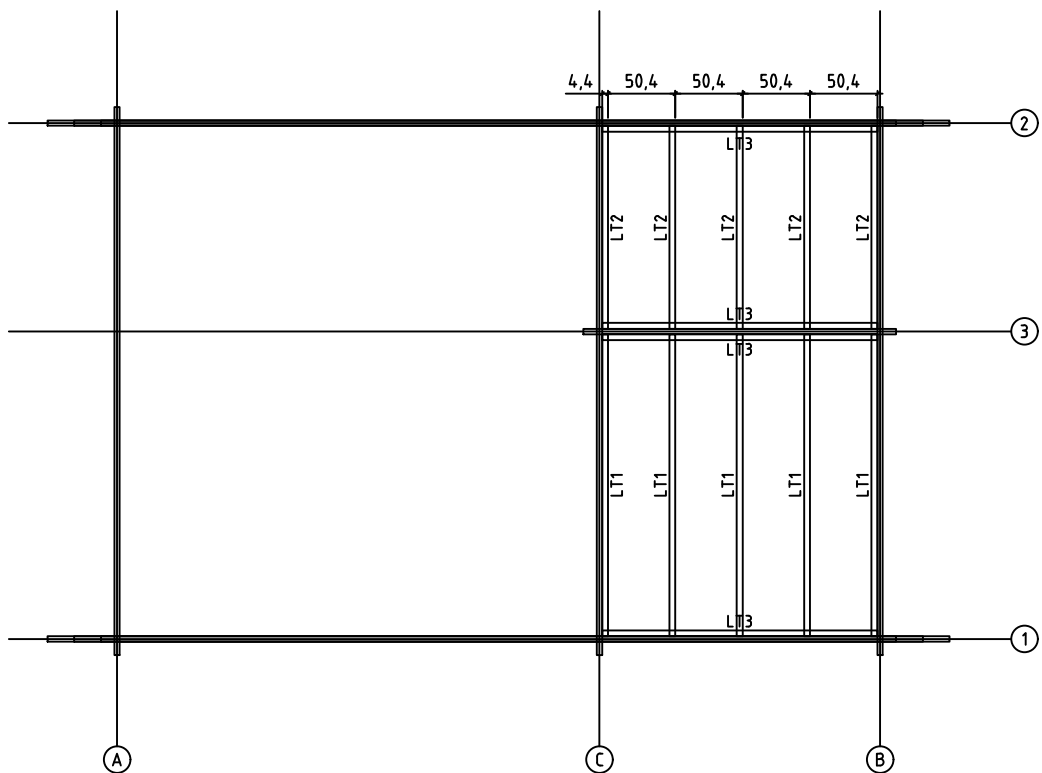

Art. Nr. 4022299

Floor boards - Fussbodenbretter -
Plan pose plancher - Pavimento -
Vloerhout - Põrandalaudis

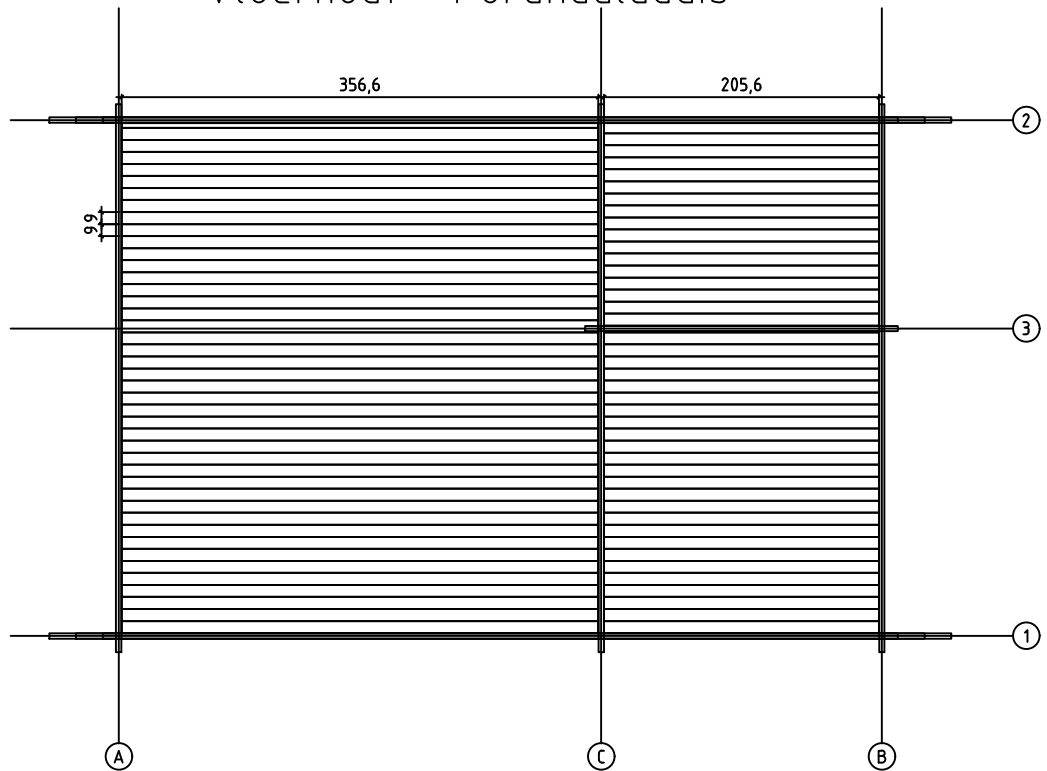

First floor floorboards - Fussbodenbretter für
erste stock - Plan pose plancher du premier etage

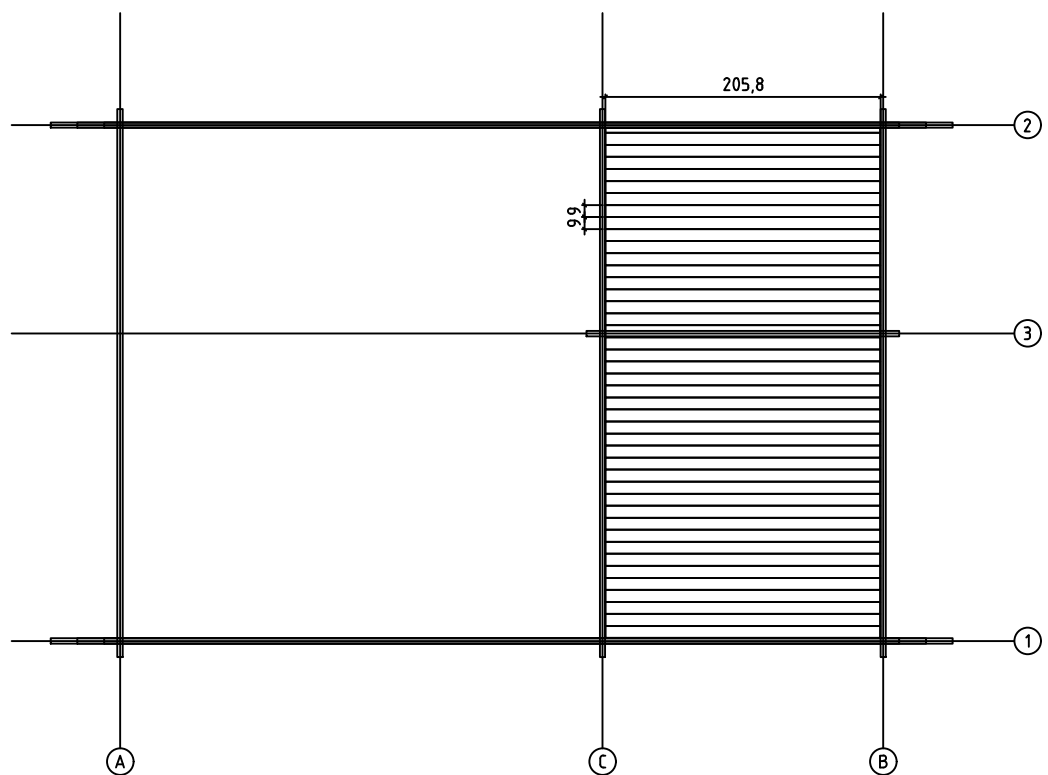

Art. Nr. 4022299

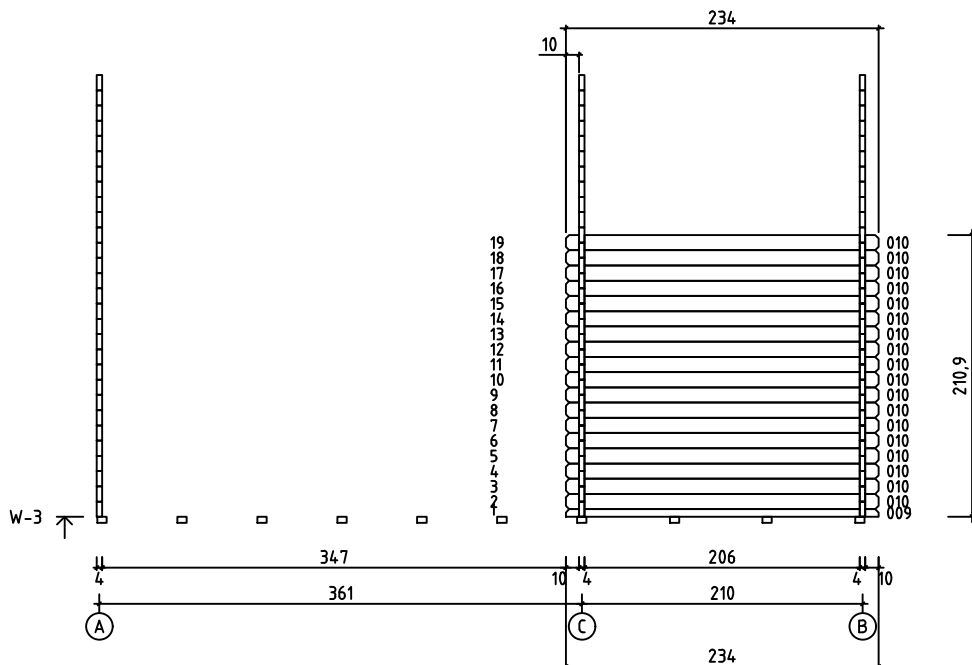
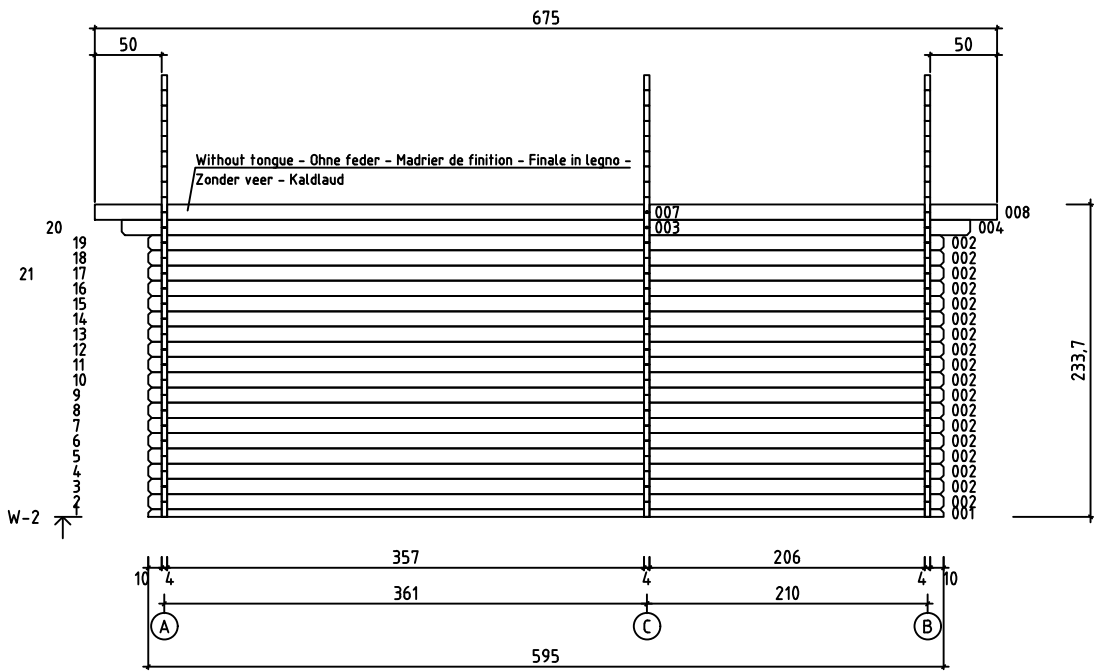
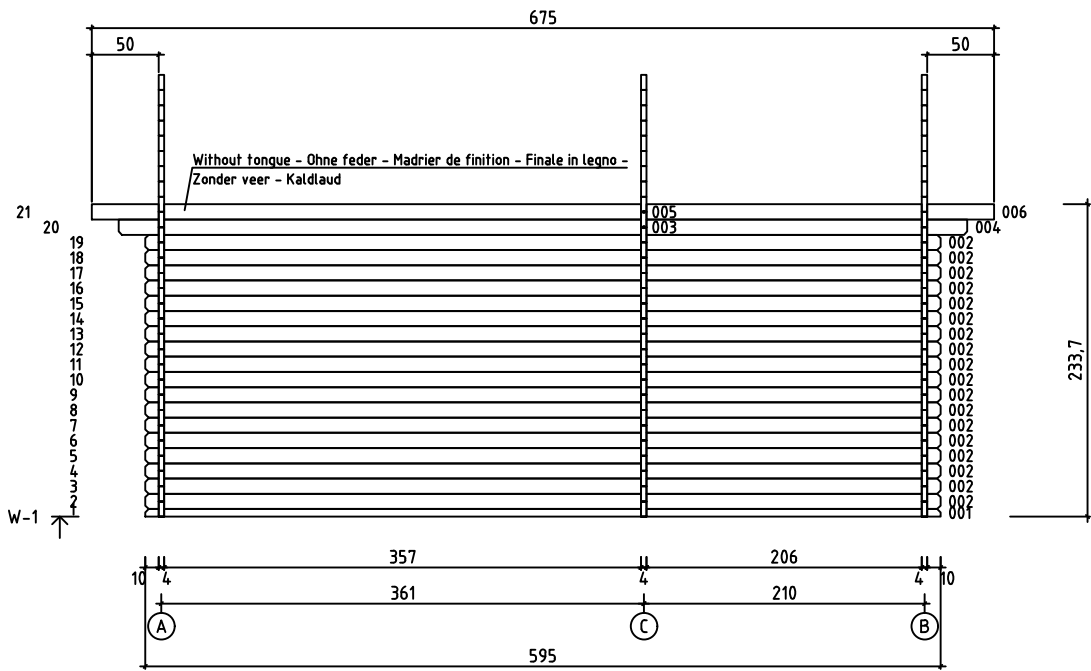

Art. Nr. 4022299

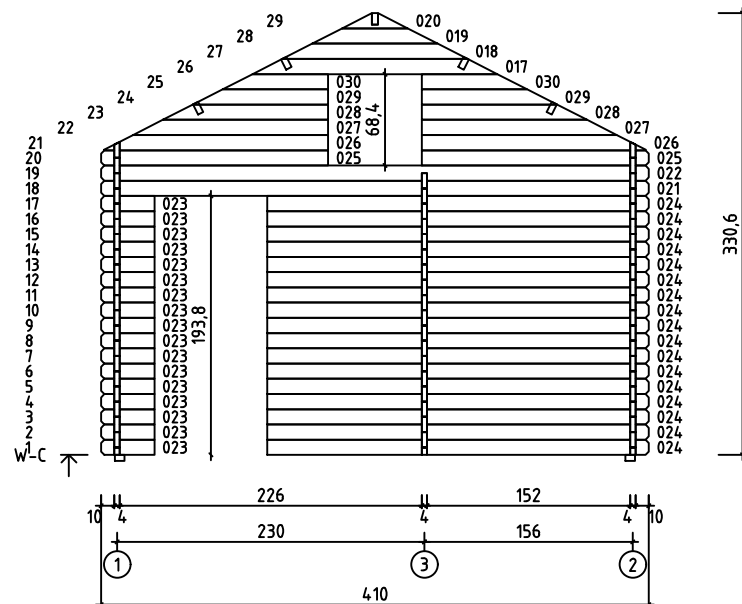
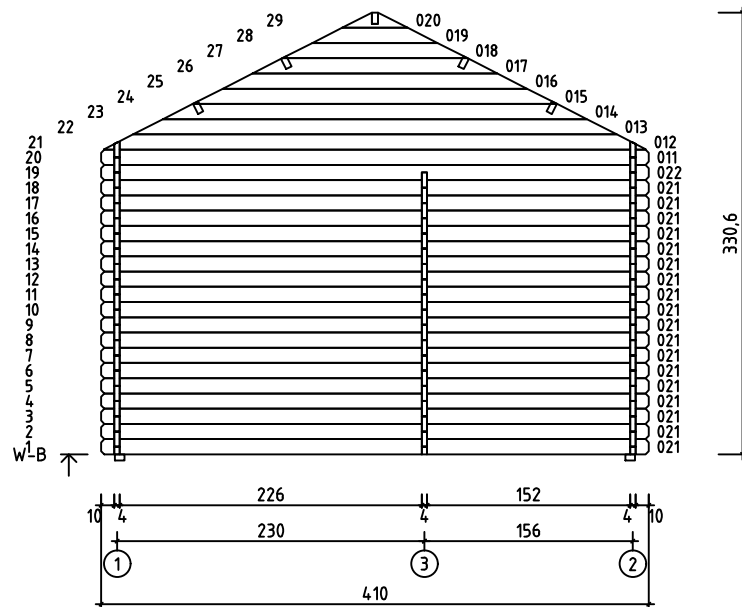
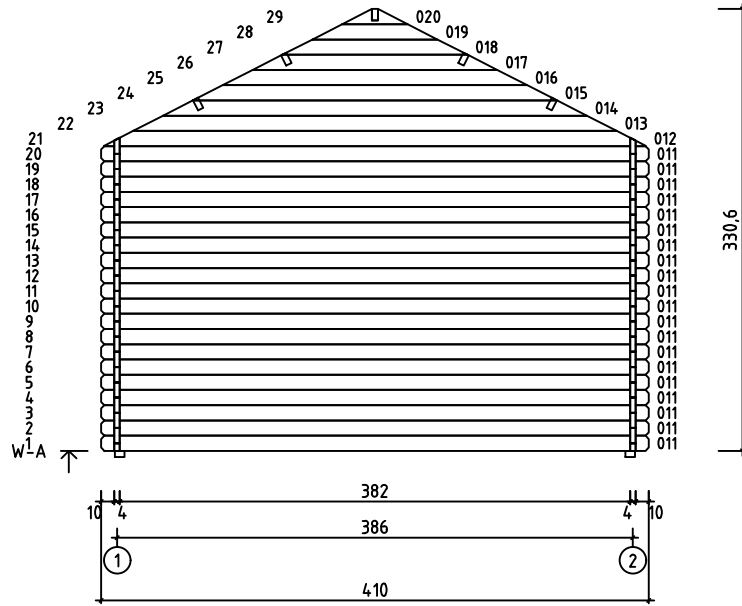

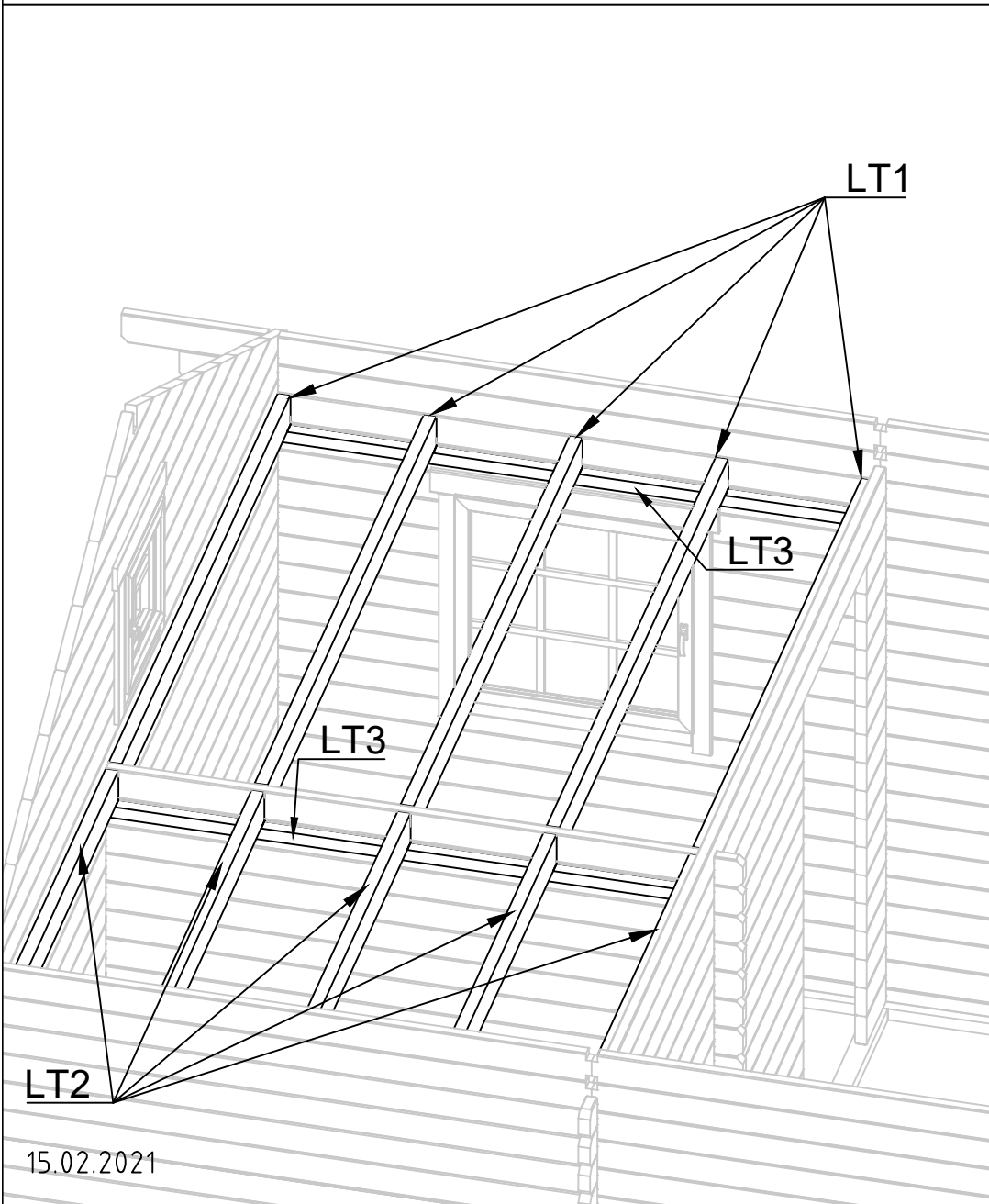



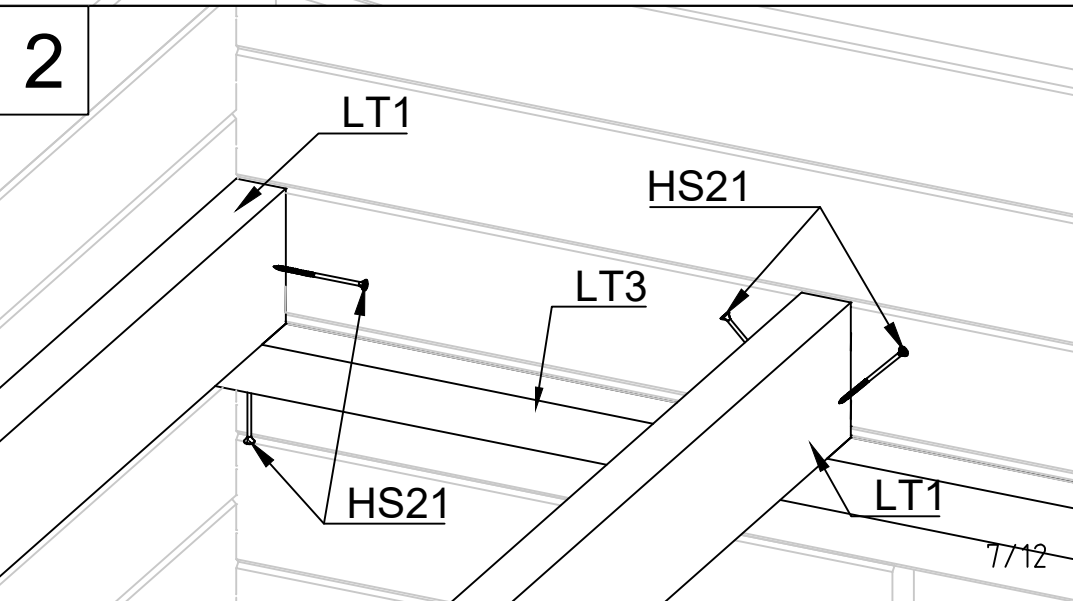
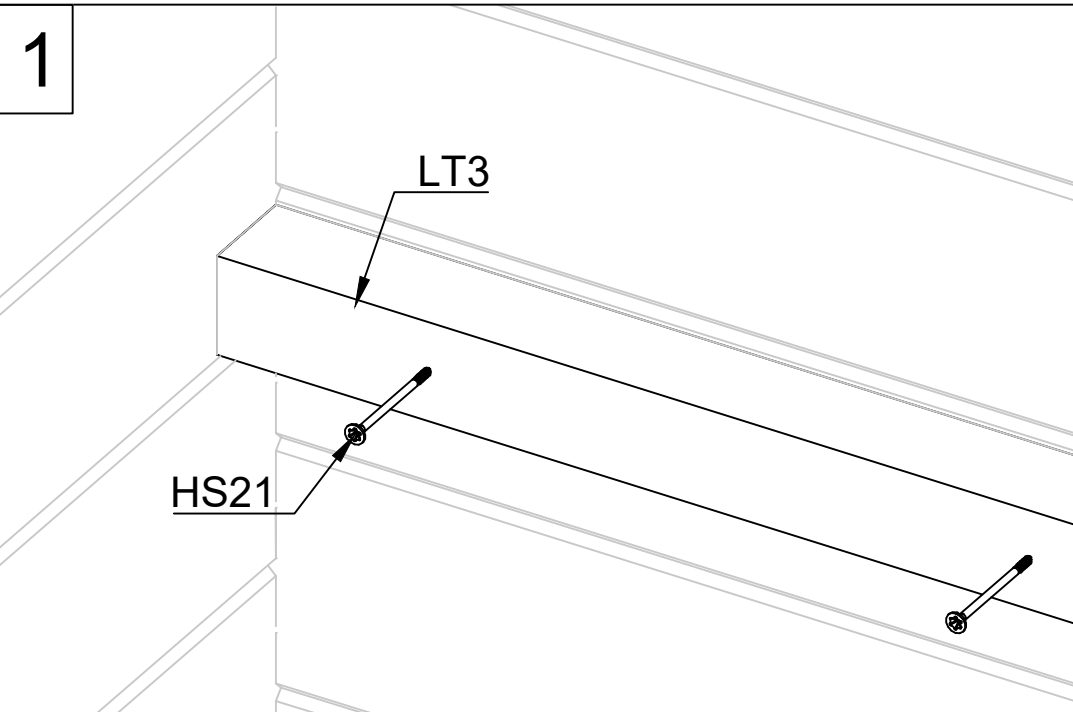

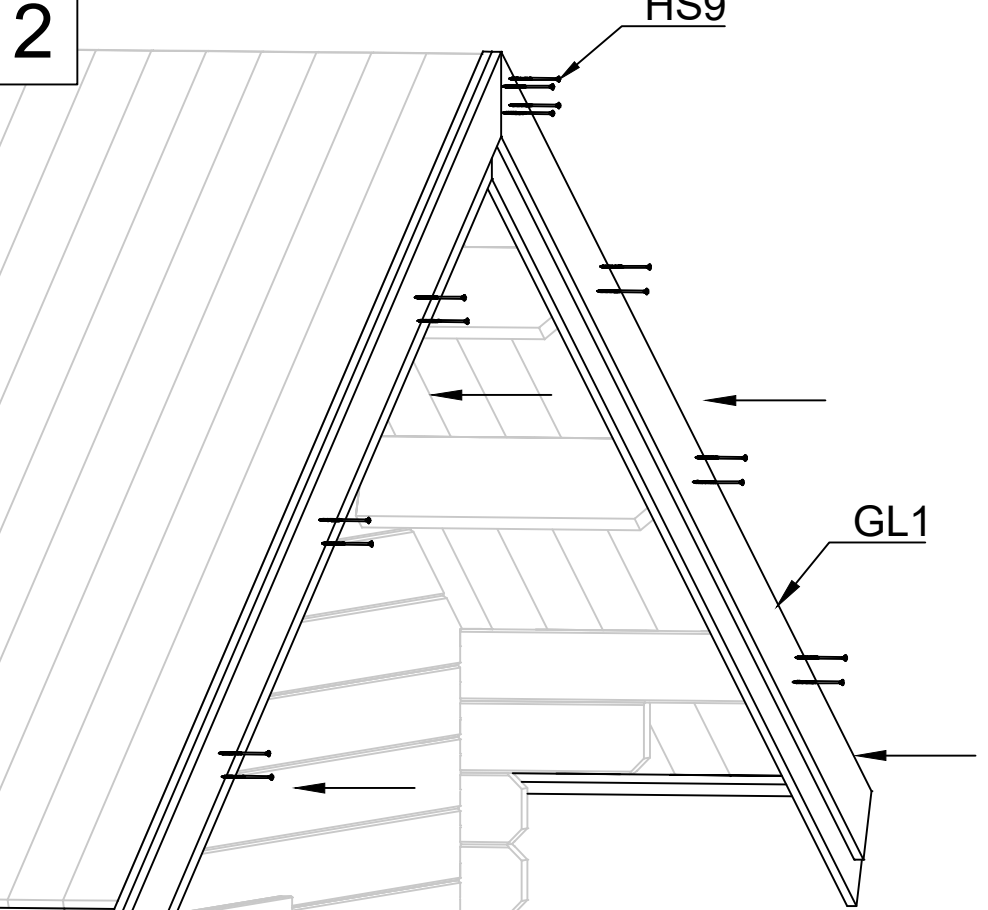
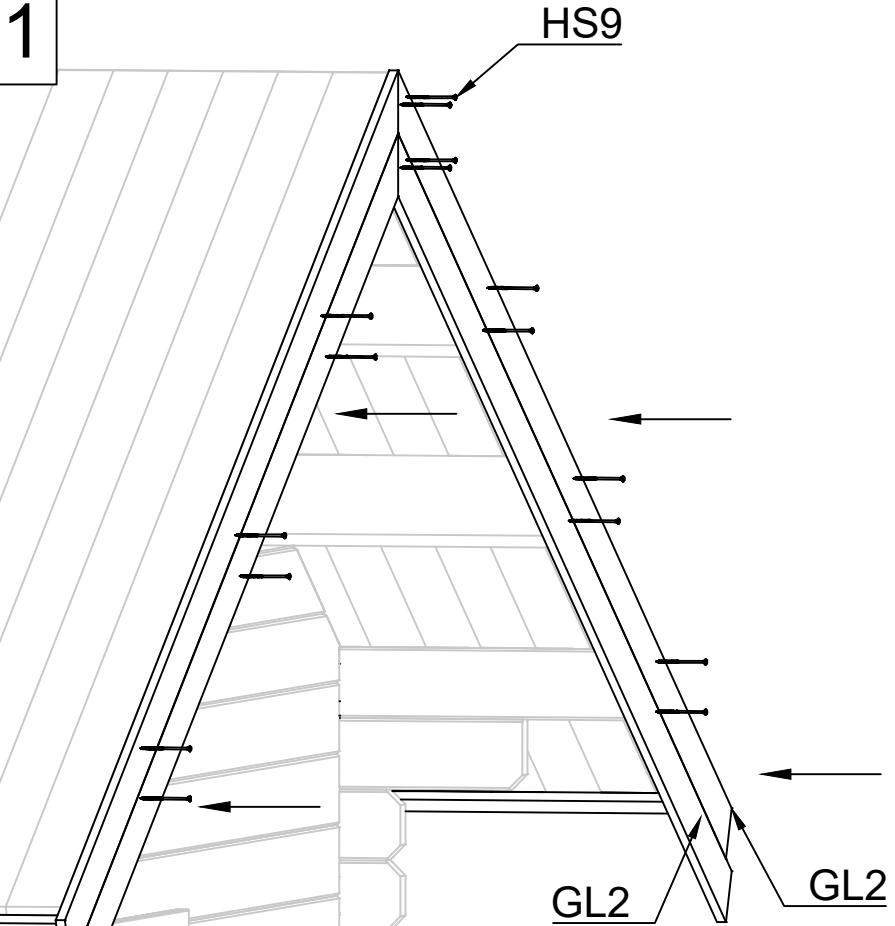

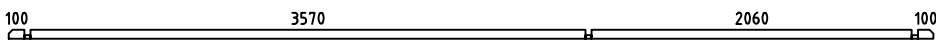
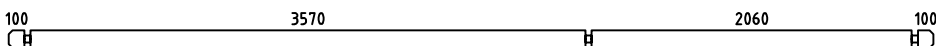
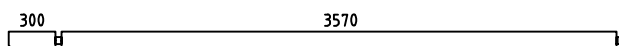
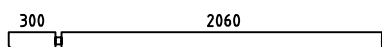
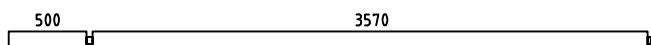
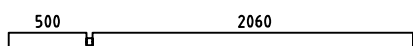
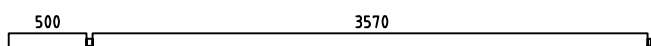
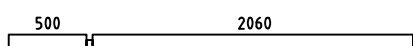
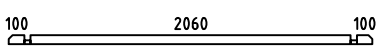
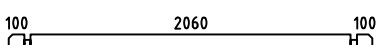
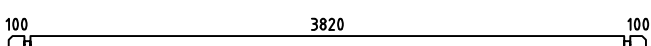
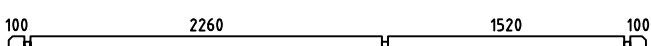
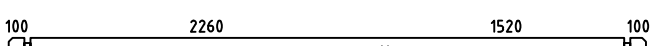

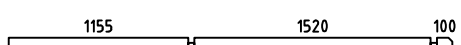
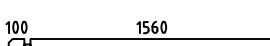
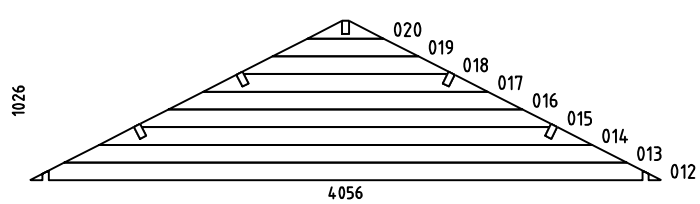
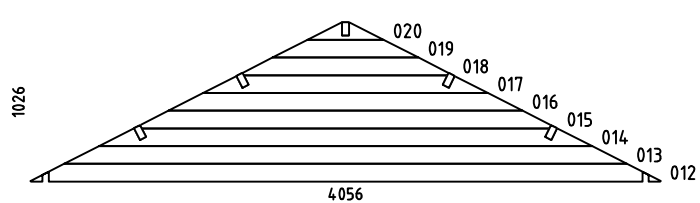





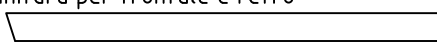
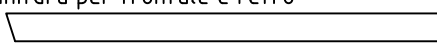

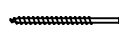
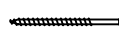
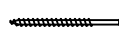
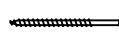
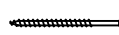

15.02.2021

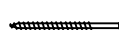

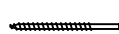

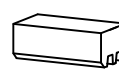
Pos	15.02.2021 Piece list - Stückliste - Liste des pièces - Elementi - Stuklijst - Tükítabel Art. Nr. 4022299 9/12	Q	P (mm)	L (mm)
001		2	40x57	5950
002		36	40x114	5950
003		2	40x114	3930
004		2	40x114	2420
005		1	40x120	4130
006		1	40x120	2620
007		1	40x120	4130
008		1	40x120	2620
009		1	40x57	2340
010		18	40x114	2340
011		21	40x114	4100
021		19	40x114	4100
022		2	40x114	4100
023		17	40x114	400
024		17	40x114	2855
025		2	40x114	1700
WA-1		1		
WB-1		1		

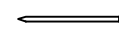
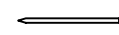
Pos	15.02.2021 Piece list - Stückliste - Liste des pièces - Elementi - Stuklijst - Tükitalabel Art. Nr. 4022299 10/12	Q	P (mm)	L (mm)
WC-1		1		
LT3	Mezzanine floor joists - Halbgeschoss balken - Solives de plancher mezzanine - Travi del pavimento mezzanino - Plaatduim scharnier - Laetalad 	4	45x45	2060
LT1	Mezzanine floor joists - Halbgeschoss balken - Solives de plancher mezzanine - Travi del pavimento mezzanino - Plaatduim scharnier - Laetalad 	5	44x120	2260
LT2	Mezzanine floor joists - Halbgeschoss balken - Solives de plancher mezzanine - Travi del pavimento mezzanino - Plaatduim scharnier - Laetalad 	5	44x120	1520
IAR2	Foundation - Fundament - Fondation - Fondamenta - Fundering - Immutatud alusraam 	2	70x45	5740
IAR1	Foundation - Fundament - Fondation - Fondamenta - Fundering - Immutatud alusraam 	10	70x45	3750
IAR3	Foundation - Fundament - Fondation - Fondamenta - Fundering - Immutatud alusraam 	1	70x45	100
A-PR1	Roof beam - Dachbalken - Panne de toit - Perlina del tetto - Gordingen / dakbalk - Pärilin 	5	44x140	4130
A-PR2	Roof beam - Dachbalken - Panne de toit - Perlina del tetto - Gordingen / dakbalk - Pärilin 	5	44x140	2620
FB1	Floor boards - Fussbodenbretter - Lame de plancher - Pavimento - Vloerhout - Põrandalaud	43	90x18	3566
FB2	Floor boards - Fussbodenbretter - Lame de plancher - Pavimento - Vloerhout - Põrandalaud	86	90x18	2056
	Roof boards - Dachbretter - Voliges - Perlina per tetto - Dakhout - Katuselaud	150	90x18	2750
	Floor fillet - Fussbodenteiste - Corniere de finition du plancher - Finitura per pavimento (battisco pa) - Vloerafwerklijst - Põrandaliist		18x18	43
	Roofing felt fillet - Dachpappenteiste - Baguette de fixation du feutre bitumeux - Asse per fissaggio guaina bituminosa - Afdeklijst asfaltpapier - Katusepapiiist	4	18x58	2800
	Doorstep - Swelle - Seuil de porte - Callare - DrempeL - Lävepakk ukseavale	1	18x44	845
TB-1	Fascia board - Traufbrett - Bandeau de toit - Finitura lati tetto - Gevellijst Räästalaud	4	18x90	3375
DRV-1	Roof edge reinforcement - Dachrandverstärkung - Corniere de renfort de bord de toit - Rinforzo x tetto - Dakrand versterking - Räästatugevdus	4	28x34	3375
KFS-1	Storm protection - Sturmleiste - Latte anti-tempete - Protezione anti vento - Stormverankering / beveiliging - Tormikinnitusliist	6	22x45	2500
UP1	U-profile - U-profils - Profile u - Profilo ad u - U-profiel - U-profiil	2	35x70	690
UP2	U-profile - U-profils - Profile u - Profilo ad u - U-profiel - U-profiil	1	35x70	720
UP3	U-profile - U-profils - Profile u - Profilo ad u - U-profiel - U-profiil	1	35x70	865

Pos	15.02.2021 Piece list - Stückliste - Liste des pièces - Elementi - Stuklijst - Tükitalabel Art. Nr. 4022299 11/12	Q	P (mm)	L (mm)
UP4	U-profile - U-profils - Profile u - Profilo ad u - U-profiel - U-profiil 	2	35x70	1930
GL1	Gable moulding - Giebelleiste - Planche de rive - Finitura per frontale e retro del tetto - Gevellijst - Viilulaud 	4	18x120	2800
GL2	Gable moulding - Giebelleiste - Planche de rive - Finitura per frontale e retro del tetto - Gevellijst - Viilulaud 	8	18x90	2800
HS8	Screw for gable segment - Schrauben für deckblatt - Vis pour fixation losange de finition - Viti x frontali tetto - Schroef voor gevelpunt segment - Kruvi 	4	3.5x35	
HS9	Screw for gable moulding - Schrauben für giebelleiste - Vis pour fixation planche de rive - Vite per fissare finiture davanti e dietro del tetto - Schroef voor gevellijst - Kruvi viilulauale 	90	3.5x50	
HS4	Screw for doorstep - Schrauben für swelle - Vis pour fixation barre de seuil - Vite per soglia della porta - Schroef voor deurdorpel - Kruvi lävepakule 	3	3x30	
HS4	Screw for roof edge reinforcement - Schrauben für dachrandverstärkung - Vis pour fixation corniere renfort de bord de toit - Viti x rinforzo bordo tetto - Schroef voor dakrand versterking - Kruvi räästatugevdusele 	32	3x30	
HS12	Screw for universal hook - Schrauben für universalhaken - Vis pour crochets universels - Vite per gancio universale - Schroef voor universele haak - Kruvi redeli fiksaatorile 	4	4x40	
HS13	Screw for u-profile - Schraube zur befestigung u-profils - Vis a tete fraisée pour profil u - Vite per profilo ad u - Schroef ter bevestiging u-profiel - Kruvi U-profiilile 	19	4x60	
HS13	Screw for stepladder - Schraube für leiter - Vis d'assemblage des marches de l'échelle - Vite per scaletta - Schroef voor trapladder - Kruvi redeli montaažiks 	34	4x60	
HS18	Screw for foundation - Schrauben zur befestigung fundament - Vis de fixations des poutrelles de fondations - Viti x fondamenta - Schroef voor fundering - Kruvi alusraamile 	21	5x120	
HS18	Screw for roof beams - Schrauben für dachbalken - Vis pour fixation pannes de toit - Viti per perline del tetto - Schroef voor gordingen / dakbalken - Kruvi pärlinitele 	20	5x120	
HS18	Screw for wall details - Schraube für wand details - Vis pour mur details - Viti per elementi della porta - Schroef voor wand details - Kruvi seinadetailile 	8	5x120	
HS18	Screw for gable - Schrauben für giebel - Vis pour fixation des pignons - Viti per timpano - Schroef voor gevelpunt - Kruvi viilude kinnitamiseks 	6	5x120	
HS16	Screw for 1. wall beam - Schraube für 1. bohlenreihe - Vis de fixations 1ere rangée de madriers avec poutrelles de fondations - Vite fissaggio alle fondamenta - Schroef voor 1 wandbalk - Kruvi poollauale 	12	5x90	
HS21	Screw for beam - Schrauben zur befestigung dachsparren - Vis pour solive - Viti per perline - Schroef voor balk (gording) - Kruvi talale 	68	6x80	
NF2	Zn nail for floor fillet - Zn nagel für fussbodenleiste - Pointe pour corniere de finition du plancher - Chiodi x fissaggio pavimento - Spijker(nagel) voor vloer afdeklijst - Nael põrandaliistule 	128	1.4x40	
SH40	Hammer block - Schlagholz - Calle de frappe - Blocco di legno da usare come cuscinetto quando si usa il martello - Slagklos - Löögiklots 	1		
SFS	Nut for storm protection - Schraubenmutter für sturmleiste - Erou pour latte anti-tempete - Dado x asta protezione vento - Moer voor stromverankering - Mutter tormikinnusliistule 	12	D6	
NF4	Zn nail for roof - Zn nagel für dachbretter - Pointe pour fixation voliges de toit - Chiodi x perline tetto - Spijker(nagel) voor dakhout - Nael katuselauale 	626	2x50	
NF4	Zn nail for floor - Zn nagel für fussbodenbretter - Clous pour plancher - Chiodi x perline pavimento - Spijker(nagel) voor vloer - Nael põrandalauale 	828	2x50	
NF5	Zn nail for roofing felt fillet - Zn nagel für dachpappenleiste - Pointe pour baguette de fixation feutre bitumeux - Chiodi x carta bituminosa x tetto - Spijker(nagel) voor asfaltpapier afdeklijst - Papiliistunael 	28	2x40	
BFS	Bolt for storm protection - Bolzen für sturmleiste - Boulon pour latte anti-tempete - Bullone x asta protezione vento - Bout voor stormankerlat - Puidupolt tormikinnusliistule 	12	6x70	

