

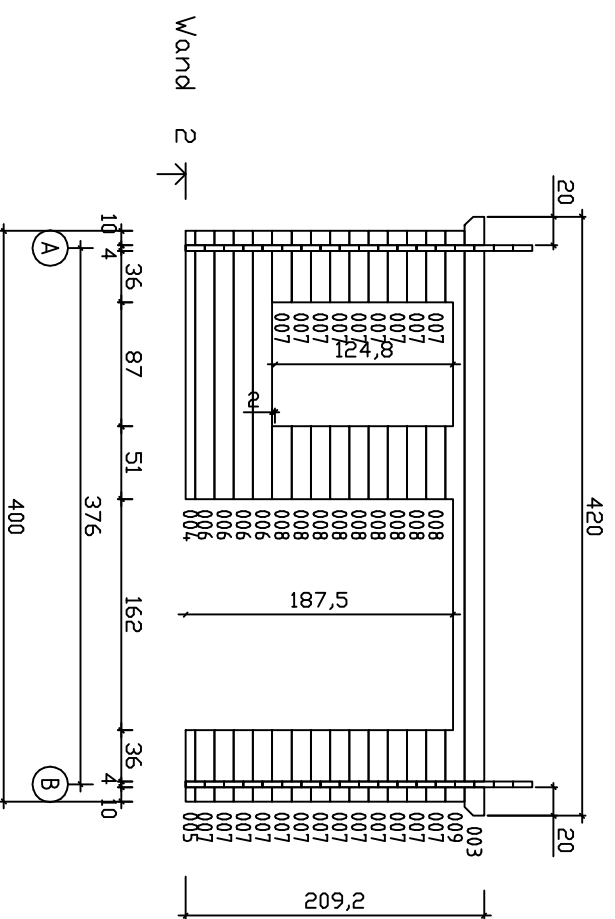

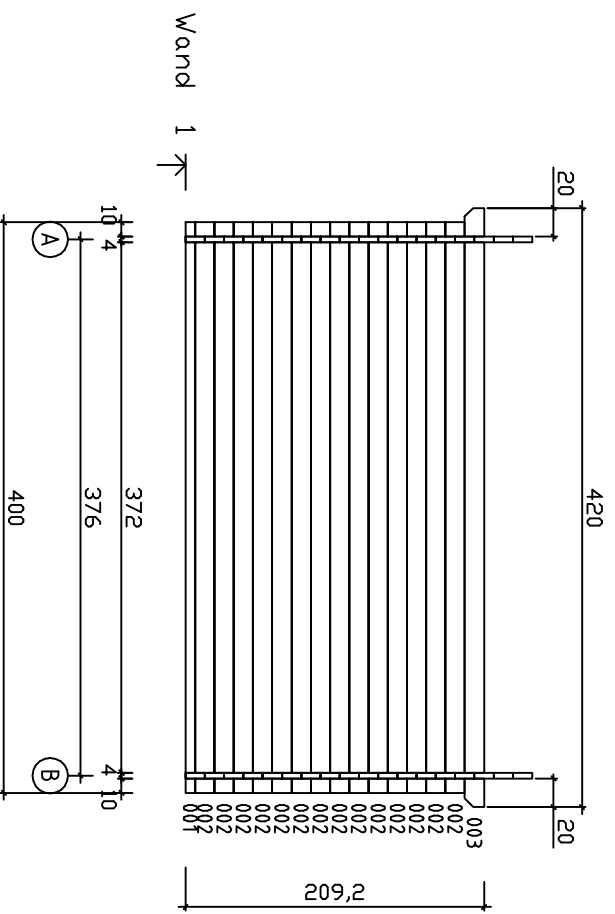

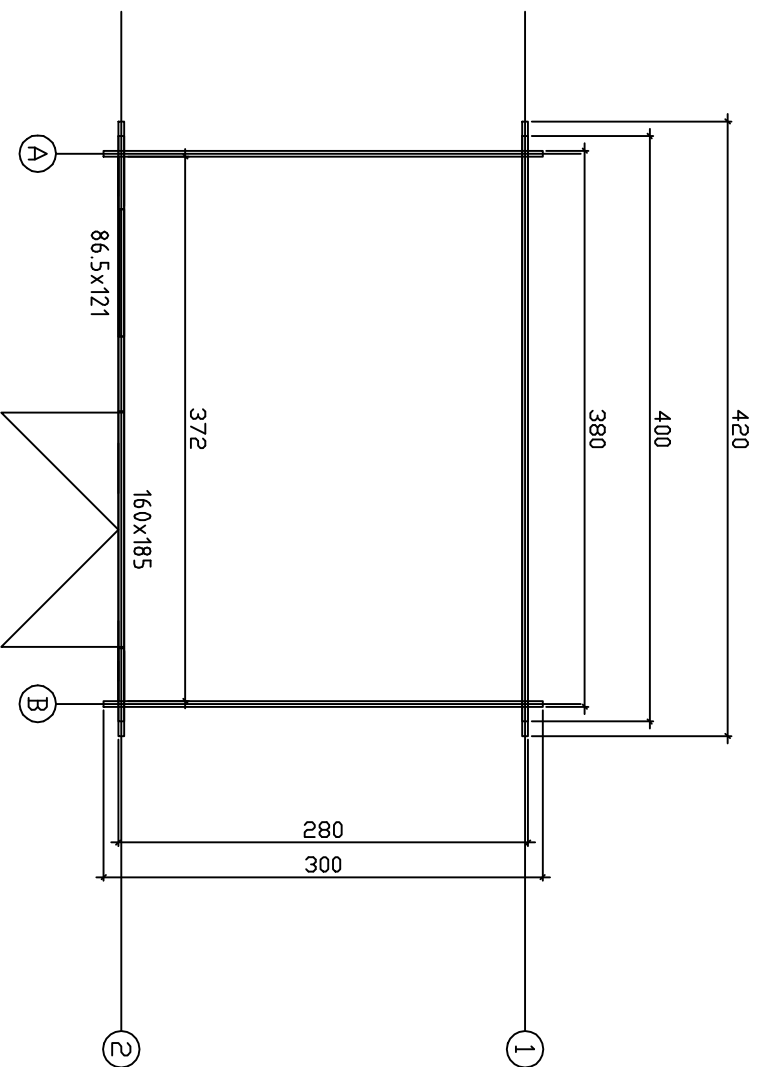

Kood	Chloe	Leht	2
Joonis	Wand A	Mootkava	1:50
Materjal	4,0x13,5	Kuup.	03.05.2016
Joonestias	File Chloe.dwg		



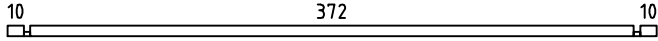
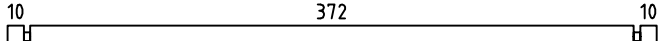
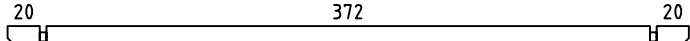
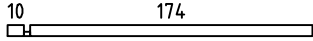

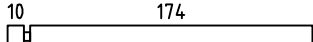

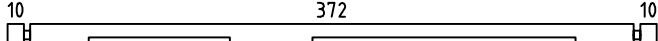
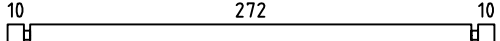
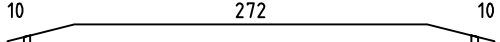
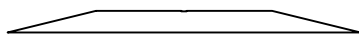

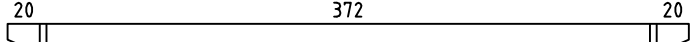
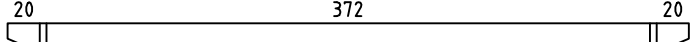
Kood	Chloe	Lehit	4
Joonis	Wand 1	Mootkava	1:50
Materjal	4,0x13,5	Kuup.	03.05.2016
Joonestias	File Chloe.dwg		

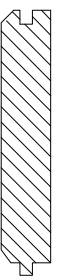

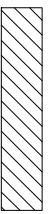
Kood	Chloe	Leht	
Joonis		Mootkava	1:50
Mä terjal	4,0 × 13,5	Kuup.	03.05.2016
Joonestas		File	Chloe.dwg

Pos	Drawing Chloe	Pcs	Profile (cm)	Length (cm)
001		1	4x6.8	400
002		14	4x13.5	400
003		2	4x13.5	420
004		1	4x6.8	188
005		1	4x6.8	50
006		4	4x13.5	188
007		22	4x13.5	50
008		9	4x13.5	51
009		1	4x13.5	400
010		30	4x13.5	300
011		2	4x13.5	300
012		2	4x13.5	217.6
013		4	4x13.1	52.7
PR1		2	4.3x14.5	420
PR2		1	4.3x14.5	420
	WINDOW 86.5x121	1		
	DOOR 160x185	1		
Kood Chloe		Materjal		File Chloe.dwg
				Leht 1/2

Pos	Drawing Chloe	Pcs	Profile (cm)	Length (cm)
018	ROOF BOARDS/DACHBRETT/VOULGE 	76 62	11.2x1.6 13.7x1.6	179 179
019	ROOF EDGE REINFORCEMENT / TRAUFFENLEISTE / TASSEAU 	2	2.6x3.2	420
020	ROOF SIDE BOARDS / TRAUFFENBRETT / PLANCHE DE RIVE 	2	1.8x6	420
021	FASCIA BOARD / GIEBELBLENDE / PLANCHE DE RIVE (FACADE) 	4	1.8x12.0	183
022	FASCIA BOARD / GIEBELBLENDE / PLANCHE DE RIVE (FACADE) 	4	1.8x6.0	183
023	DIAMOND / RAUTE / DIAMANT 	2	1.8x12	120
Kood Chloe		Materjal		File Chloe.dwg
				Leht 2/2