

Luna 40 (552x308)

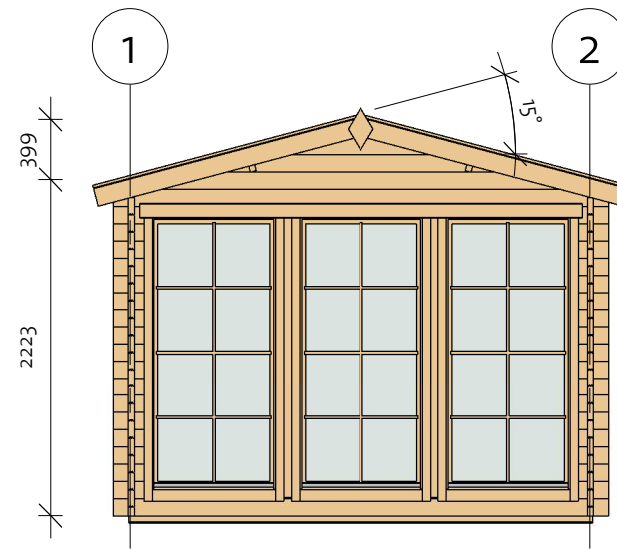
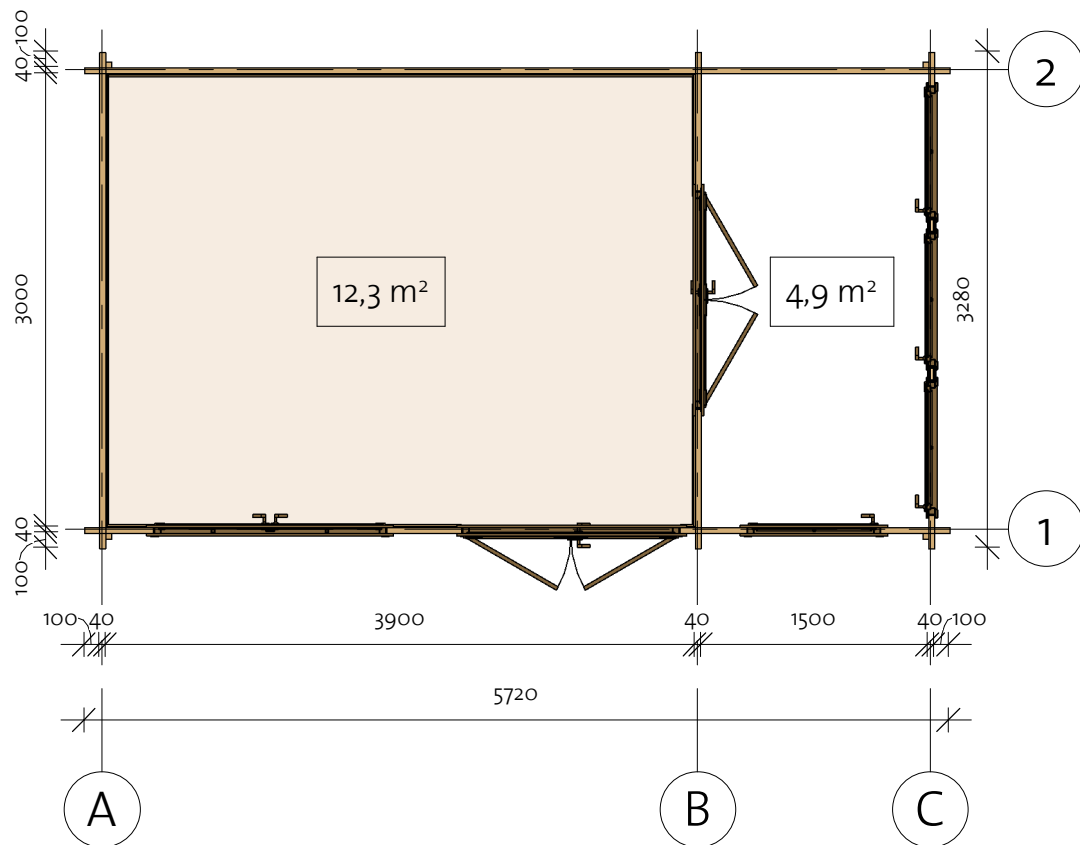

Luna 40 (552x308)

Floor Plan

① Baseboard

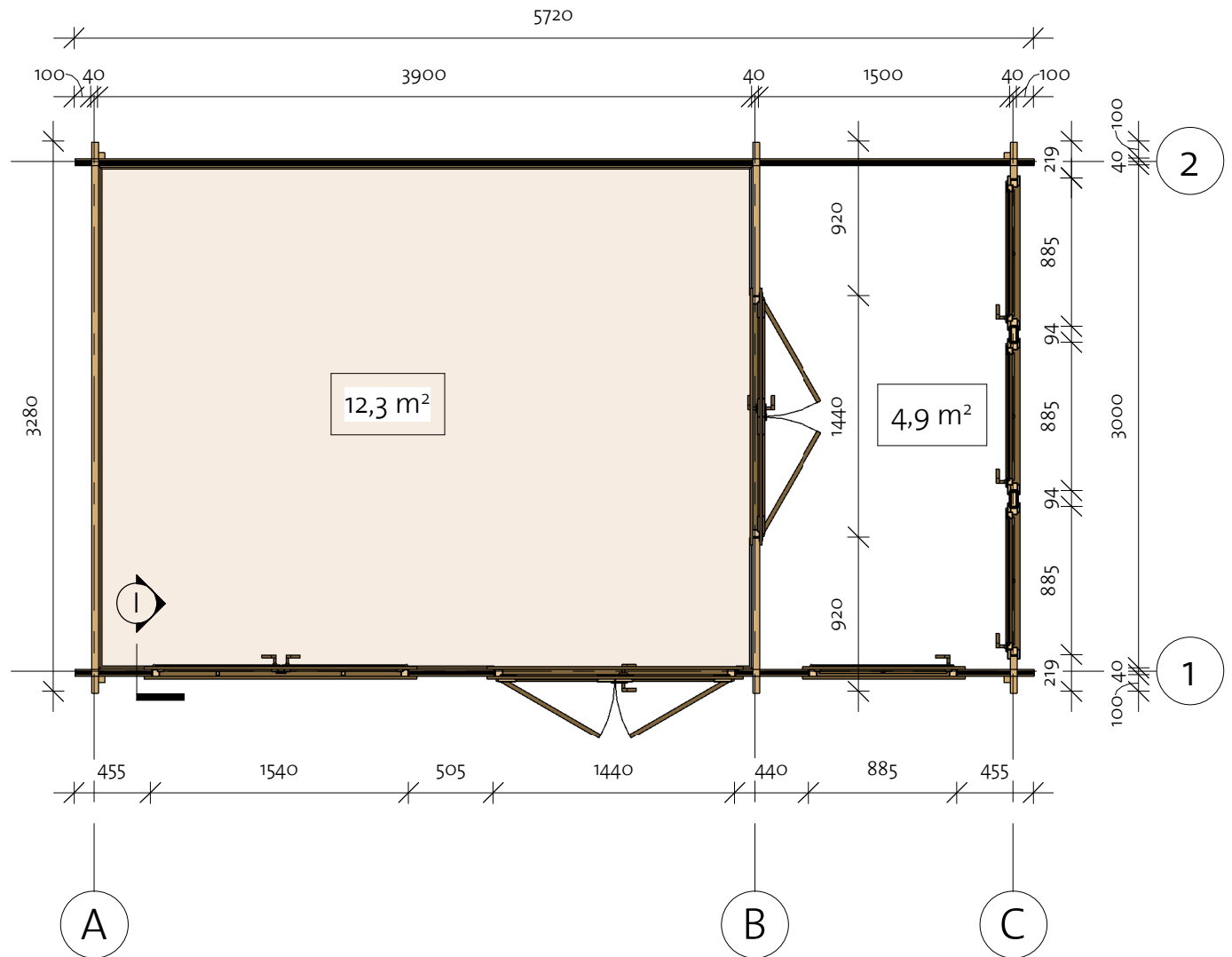
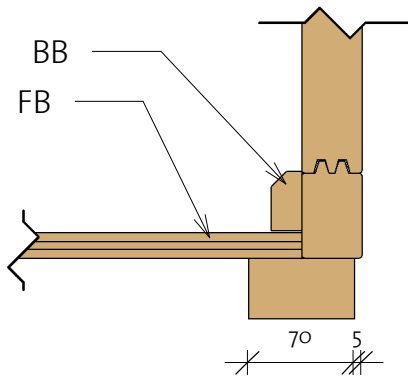

Floor Schedule

Mark	Type	Profile	Count	Length
------	------	---------	-------	--------

FB	FB 17x114		35	2997
----	-----------	--	----	------

BB1	BB 20x40		2	3980
BB2	BB 20x40		2	3080

Luna 40 (552x308)

Wall 1

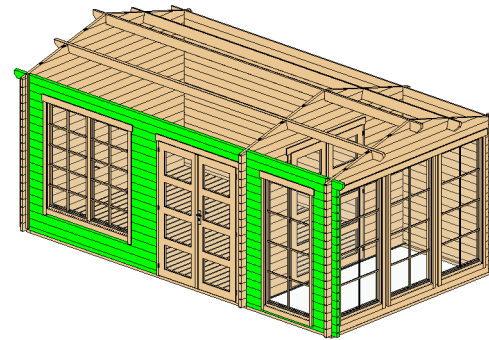

Wall 1			
Mark	Profile	Count	Cut Length

1BL-1	40X57	1	1780
1BL-2	40X57	1	2500
1LG-1	40X114	14	505
1LG-2	40X114	31	455
1LG-3	40X114	17	440
1LG-4	40X114	3	2500
1LG-5	40X114	1	5720
1TL-1	40X114	1	5920

Log Profile Wall 1	
Profile	Profile

40X57	
40X114	
40X114	

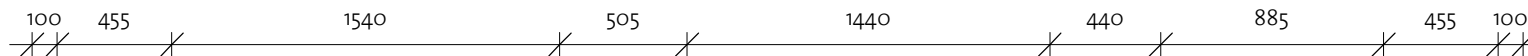
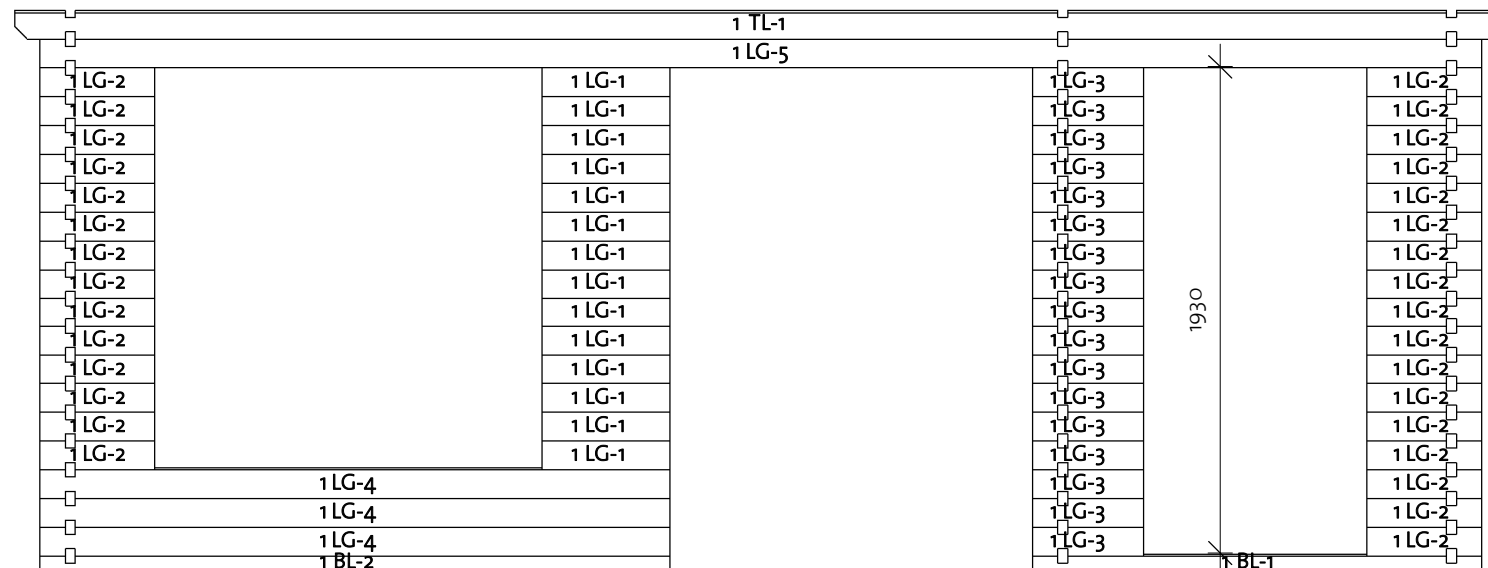

Luna 40 (552x308)

Wall 2

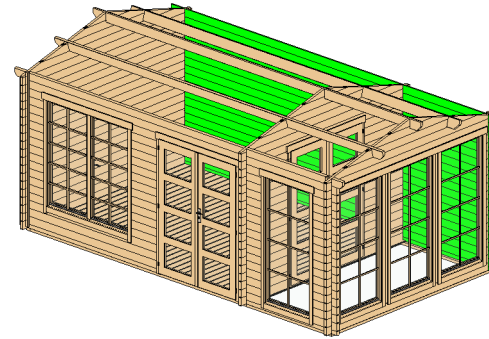

Wall 2			
Mark	Profile	Count	Cut Length
2BL-1	40X57	1	5720
2LG-1	40X114	18	5720
2TL-1	40X114	1	5920

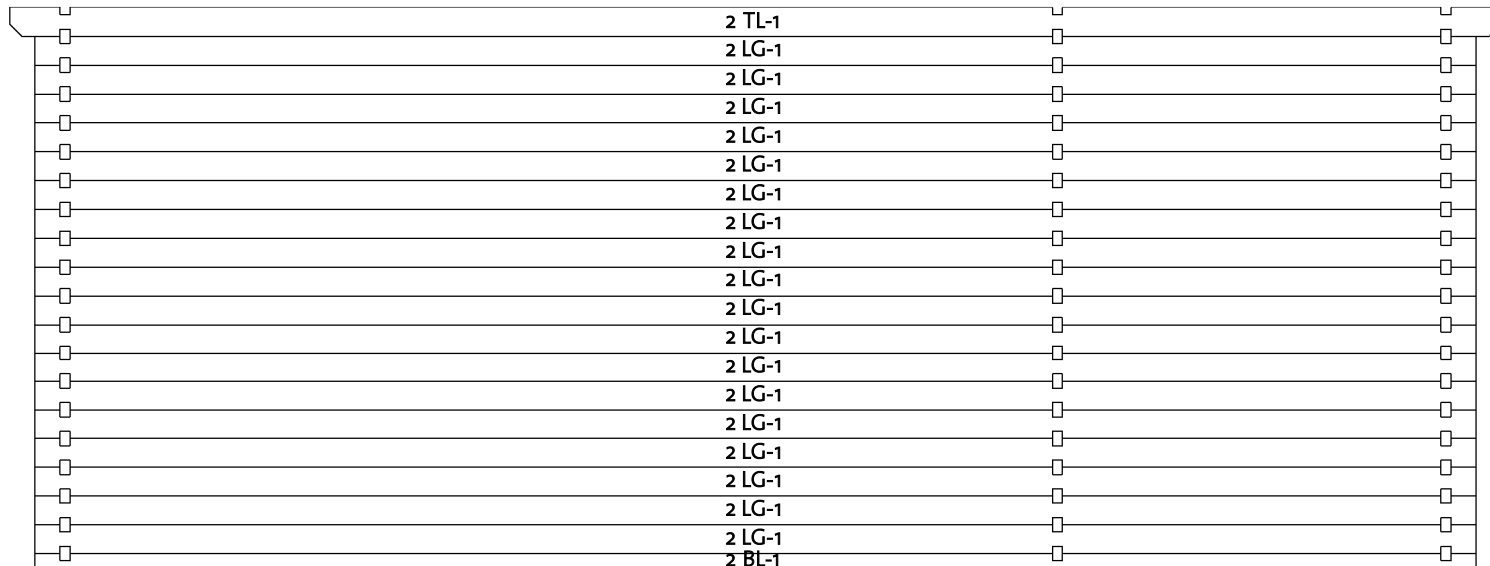



100
X X

5720

100
X X

Log Profile Wall 2	
Profile	Profile

40X57	
40X114	
40X114	

Luna 40 (552x308)

Wall A

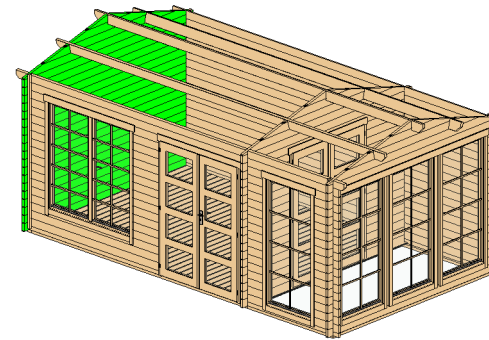

Wall A			
Mark	Profile	Count	Cut Length

ALG-1*	40x114	1	858
ALG-2*	40x114	1	1715
ALG-3*	40x114	1	2572
ALG-4	40x114	19	3280
ALG-5*	40x114	1	3280

*Gable-delivered premounted

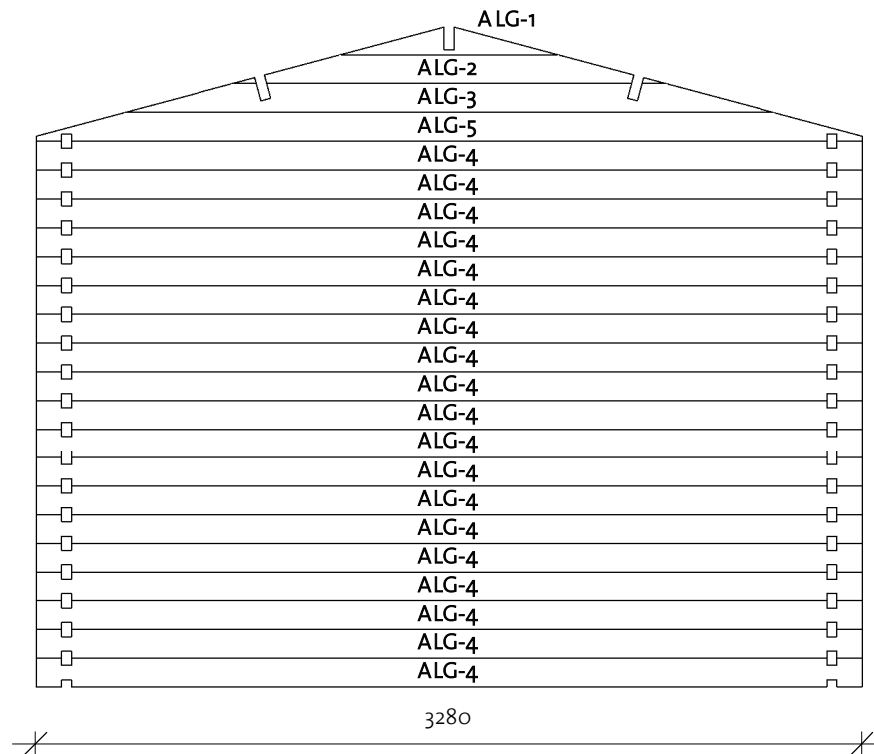

Log Profile Wall A	
Profile	Profile

40x114	
--------	--

Luna 40 (552x308)

Wall B

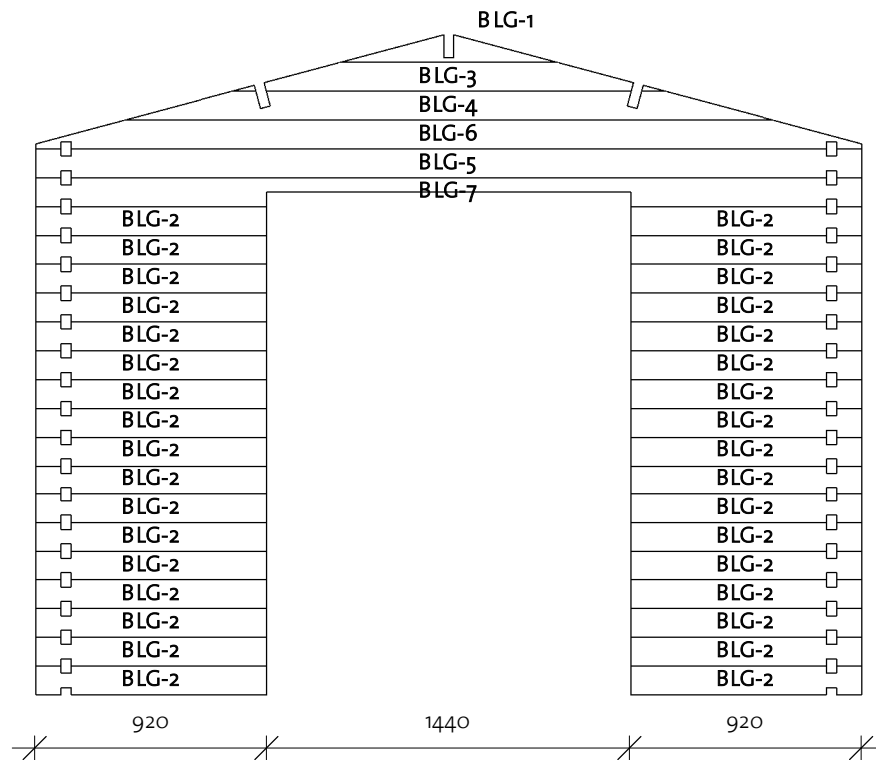
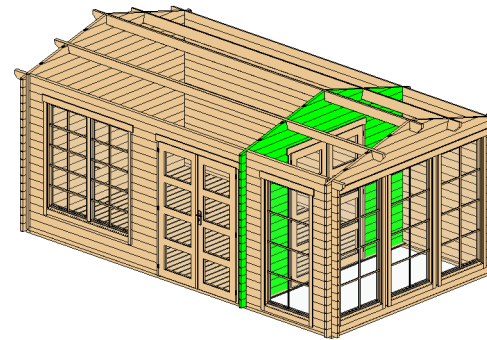

Wall B			
Mark	Profile	Count	Cut Length

BLG-1*	40x114	1	858
BLG-2	40x114	34	920
BLG-3*	40x114	1	1715
BLG-4*	40x114	1	2572
BLG-5	40x114	1	3280
BLG-6*	40x114	1	3280
BLG-7	40x114	1	3280

*Gable-delivered premounted

Log Profile Wall B	
Profile	Profile

40x114	
--------	--

Luna 40 (552x308)

Wall C

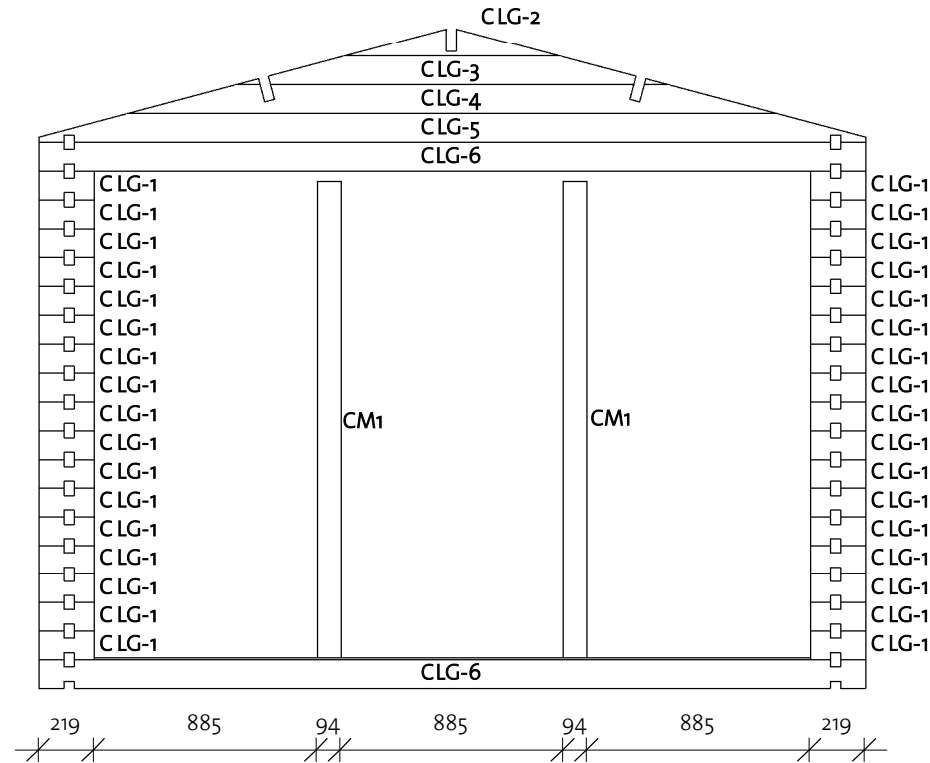
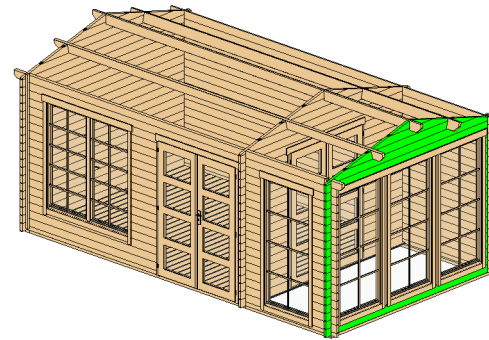

Wall C			
Mark	Profile	Count	Cut Length

CLG-1	40x114	34	219
CLG-2*	40x114	1	858
CLG-3*	40x114	1	1715
CLG-4*	40x114	1	2572
CLG-5*	40x114	1	3280
CLG-6	40x114	2	3280

*Gable-delivered premounted

Log Profile Wall C	
Profile	Profile

Columns			
Mark	Profile	Count	Length

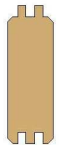

CM1	Post 40x94	2	1890
-----	------------	---	------

40x114	
--------	---

Luna 40 (552x308)

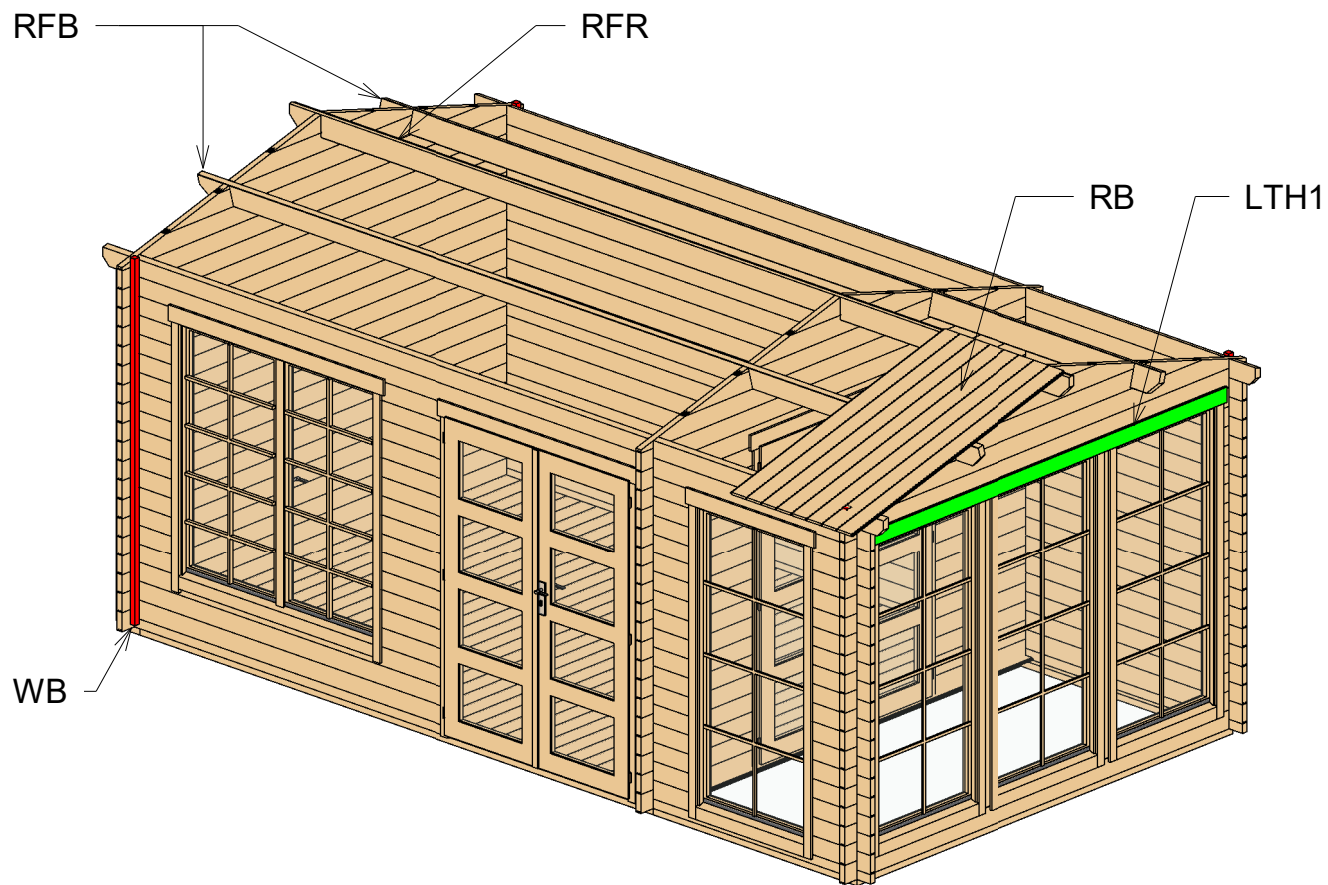
Roof 1



Roof				
Mark	Type	Profile	Count	Length
RFR	Ridge 40x143		1	5920
RFB	Beam 40x143		2	5920
RB	17x114		106	1796

Lath list				
Mark	Type	Profile	Count	Length
LTH1	18x95		2	2930

Luna 40 (552x308)

Roof 2

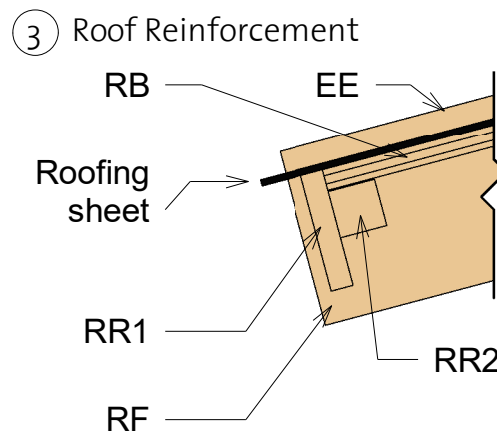
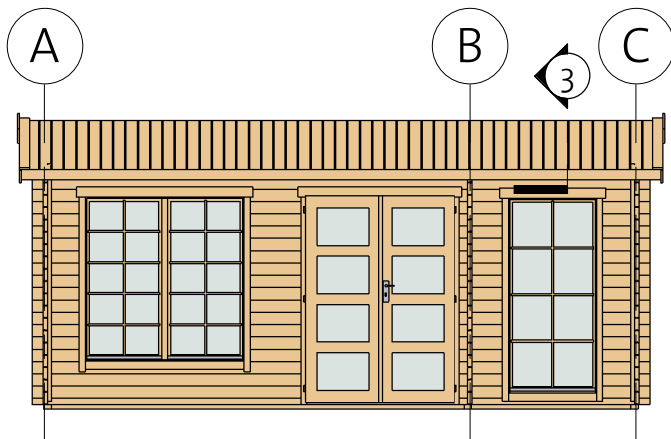
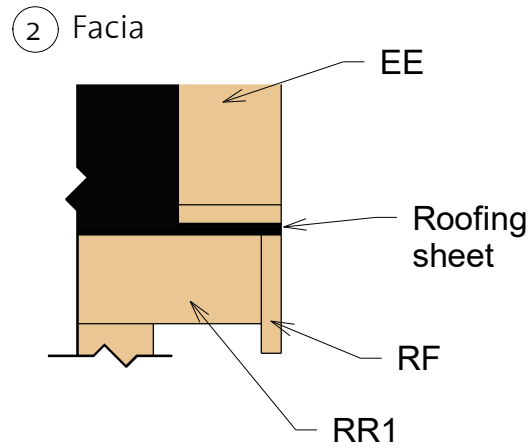
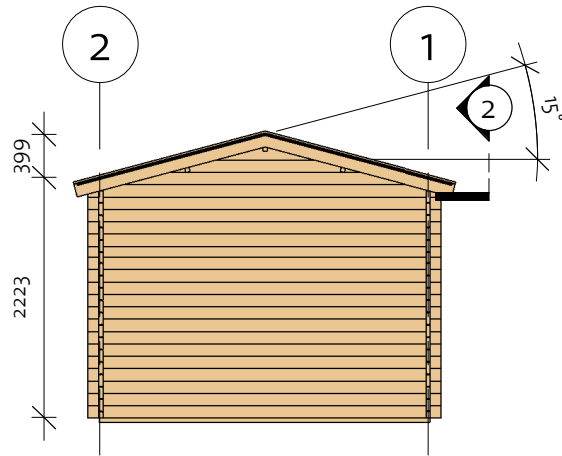

Fascia Schedule				
Mark	Type	Profile	Count	Length
EE	Eave Edging 18x95		4	1830
RF	Roof Fascia 18x120		4	1830
RR1	Roof reinforcement 18x95		2	5920
RR2	Roof reinforcement 38x38		2	5920

Luna 40 (552x308)

Extras

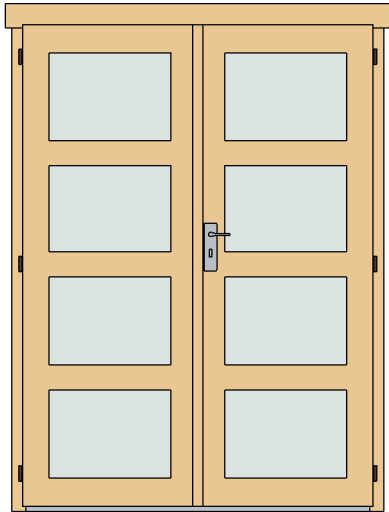

Door Schedule				
Mark	Type	Width	Height	Count
CDD2R	Classic double door 2, four glass right	1425	1955	2

Fasteners & Extras		
Name	Type	Count

Hitblock	300-400 mm	
Screws	5,0 x 70	20
Bolts	M8 x 90	20
Nails	1,4 x 40	30
Screws	6,0 x 140	65
Screws	4,0 x 40	140
Screws	4,0 x 50	650

Family	Count
Romb	2

◆

Windboard		
Type	Count	Length
Windboard 38x38	4	2200

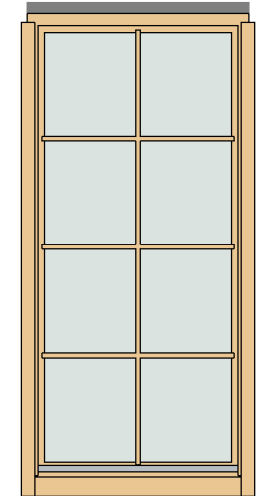
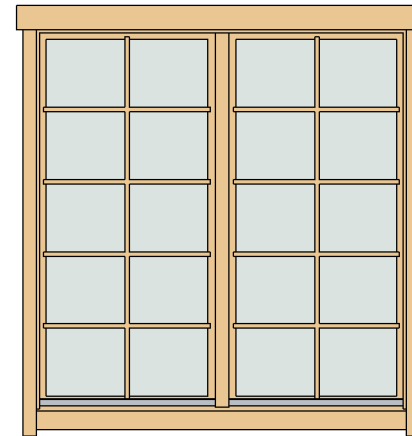



Window Schedule				
Mark	Type	Width	Height	Count
CDW4	Classic double window 4	1530	1555	1
CW4L	Classic window 4, left	875	1890	3
CW4R	Classic window 4, right	875	1890	1

WCB10	Windows Crossbar 10	--	--	2
WCB8.2	Windows Crossbar 8.2	--	--	4



Luna 40 (552x308)

List of all items 1



Impregnated foundation beams

Mark	Type	Profile	Count	Length
IFB1	IFB 70x40		7	3830
IFB2	IFB 70x40		3	3070
IFB3	IFB 70x40		2	1470





Floor Schedule

Mark	Type	Profile	Count	Length
FB	FB 17x114		35	2997
BB1	BB 20x40		2	3980
BB2	BB 20x40		2	3080

Roof

Mark	Type	Profile	Count	Length
RFR	Ridge 40x143		1	5920
RFB	Beam 40x143		2	5920
RB	17x114		106	1796

Fascia Schedule

Mark	Type	Profile	Count	Length
EE	Eave Edging 18x95		4	1830
RF	Roof Fascia 18x120		4	1830
RR1	Roof reinforcement 18x95		2	5920
RR2	Roof reinforcement 38x38		2	5920

Luna 40 (552x308)

List of all items 2

Wall 1			
Mark	Profile	Count	Cut Length

1BL-1	40x57	1	1780
1BL-2	40x57	1	2500
1LG-1	40x114	14	505
1LG-2	40x114	31	455
1LG-3	40x114	17	440
1LG-4	40x114	3	2500
1LG-5	40x114	1	5720
1TL-1	40x114	1	5920

Wall 2			
Mark	Profile	Count	Cut Length

2BL-1	40x57	1	5720
2LG-1	40x114	18	5720
2TL-1	40x114	1	5920



Lath list				
Mark	Type	Profile	Count	Length

LTH1	18x95		2	2930
------	-------	---	---	------

Columns			
Mark	Profile	Count	Length

CM1	Post 40x94	2	1890
-----	------------	---	------

Log Profiles1	
Profile	Profile

40x57	
40x114	

Log Profiles1	
Profile	Profile

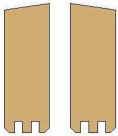
40x114	
--------	---

Luna 40 (552x308)

List of all items 3

Wall A			
Mark	Profile	Count	Cut Length

ALG-1*	40X114	1	858
ALG-2*	40X114	1	1715
ALG-3*	40X114	1	2572
ALG-4	40X114	19	3280
ALG-5*	40X114	1	3280

Wall C			
Mark	Profile	Count	Cut Length

CLG-1	40X114	34	219
CLG-2*	40X114	1	858
CLG-3*	40X114	1	1715
CLG-4*	40X114	1	2572
CLG-5*	40X114	1	3280
CLG-6	40X114	2	3280

Log Profiles2	
Profile	Profile

40X114	
--------	---

Wall B			
Mark	Profile	Count	Cut Length

BLG-1*	40X114	1	858
BLG-2	40X114	34	920
BLG-3*	40X114	1	1715
BLG-4*	40X114	1	2572
BLG-5	40X114	1	3280
BLG-6*	40X114	1	3280
BLG-7	40X114	1	3280

*Gable-delivered premounted