

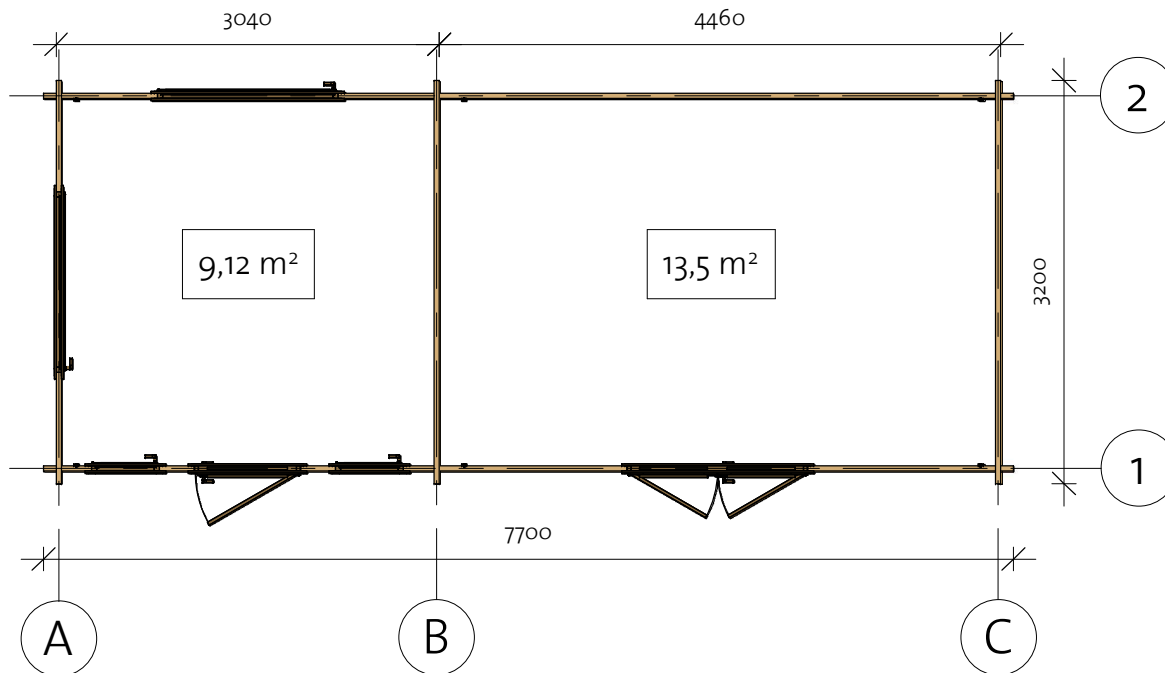

SH Oriental 5 40 Kindergarten (750x300)

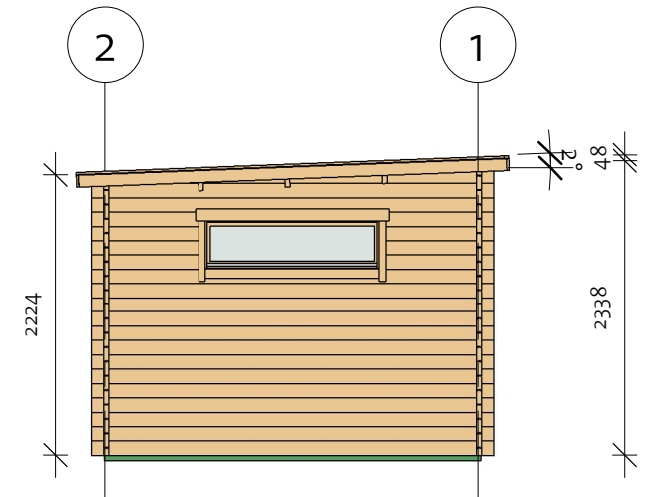
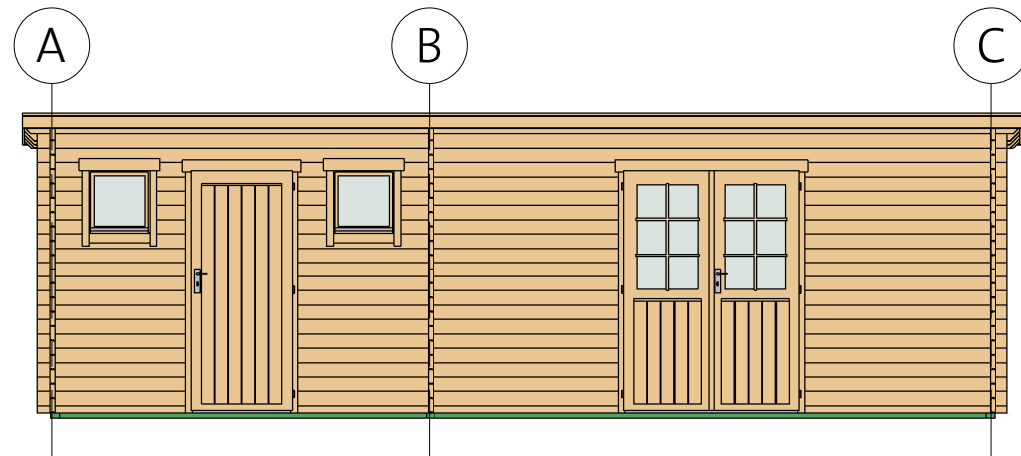

SH Oriental 5 40 Kindergarten (750x300)

Foundation

Impregnated foundation beams				
Mark	Type	Profile	Count	Length

IFB1	IFB 70x40		2	4370
IFB2	IFB 70x40		2	2910
IFB3	IFB 70x40		3	2990

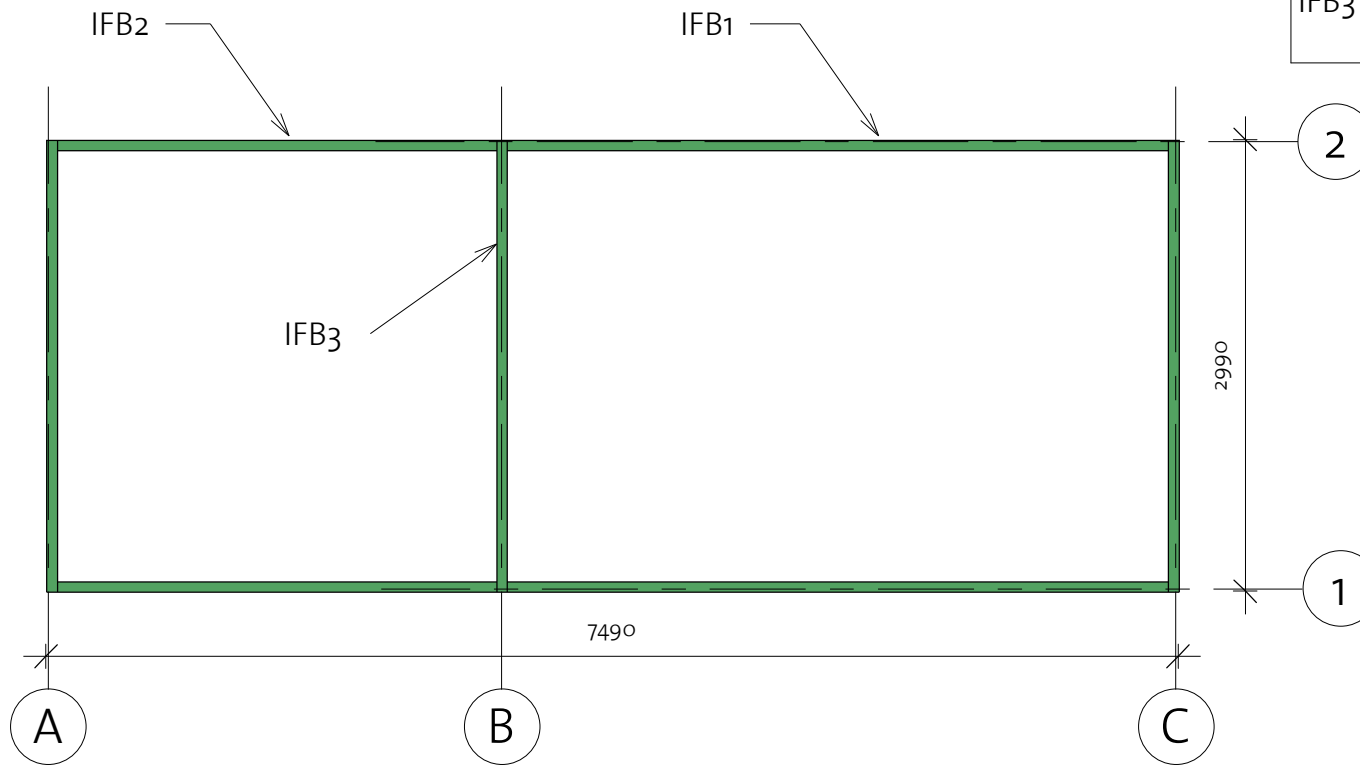



SH Oriental 5 40 Kindergarten (750x300)

Wall 1

Log Profile Wall 1	
Profile	Profile

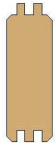
Log Profile Wall 1	
Profile	Profile

40X57	
40X114	

40X114	
--------	---

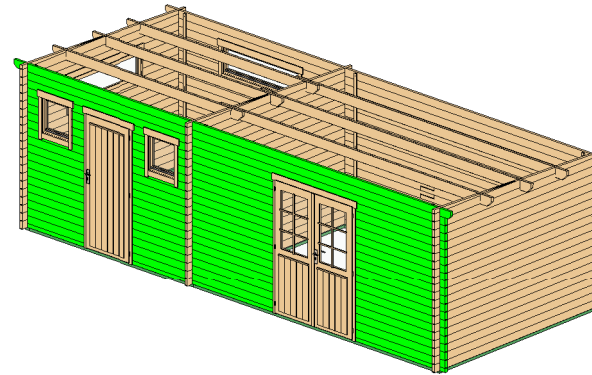

Wall 1			
Mark	Profile	Count	Cut Length

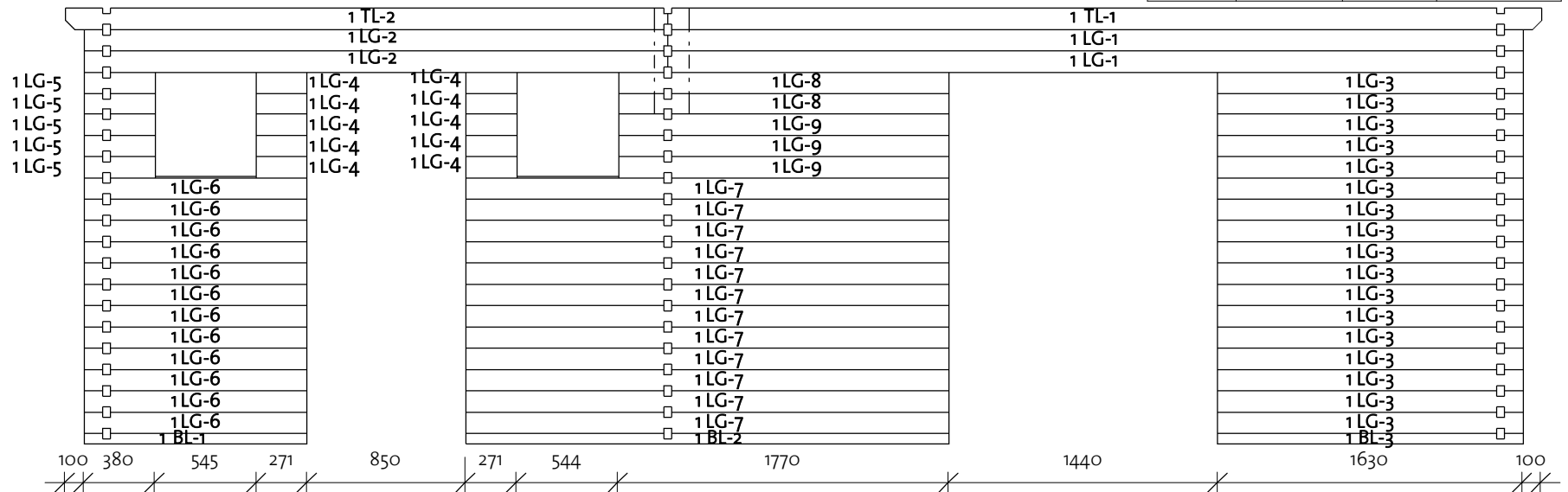

1BL-1	40X57	1	1195
1BL-2	40X57	1	2585
1BL-3	40X57	1	1630
1LG-1	40X114	2	4580
1LG-2	40X114	2	3120
1LG-3	40X114	17	1630
1LG-4	40X114	10	271
1LG-5	40X114	5	380
1LG-6	40X114	12	1195
1LG-7	40X114	12	2585
1LG-8	40X114	2	1770
1LG-9	40X114	3	1770
1TL-1	40X114	1	4680
1TL-2	40X114	1	3220



SH Oriental 5 40 Kindergarten (750x300)

Wall 2

Log Profile Wall 2	
Profile	Profile

40x57	
40x114	

Log Profile Wall 2	
Profile	Profile

40x114	
--------	---

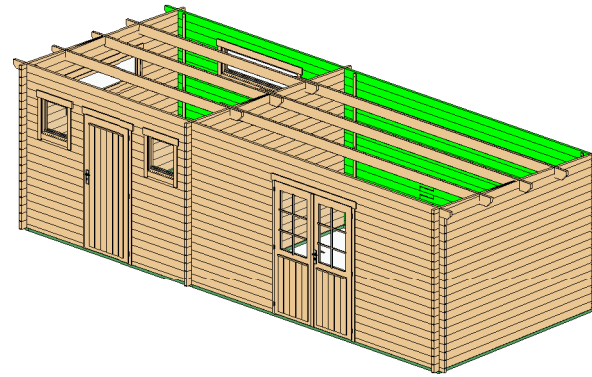

Wall 2			
Mark	Profile	Count	Cut Length

2BL-1	40x57	1	3120
2BL-2	40x57	1	4580
2LG-1	40x114	7	4580
2LG-2	40x114	10	3120
2LG-3	40x114	4	5358
2LG-4	40x114	4	4750
2LG-5	40x114	3	4580
2LG-6	40x114	4	3200
2LG-7	40x114	4	898
2TL-1	40x114	1	4680
2TL-2	40x114	1	3220

7900

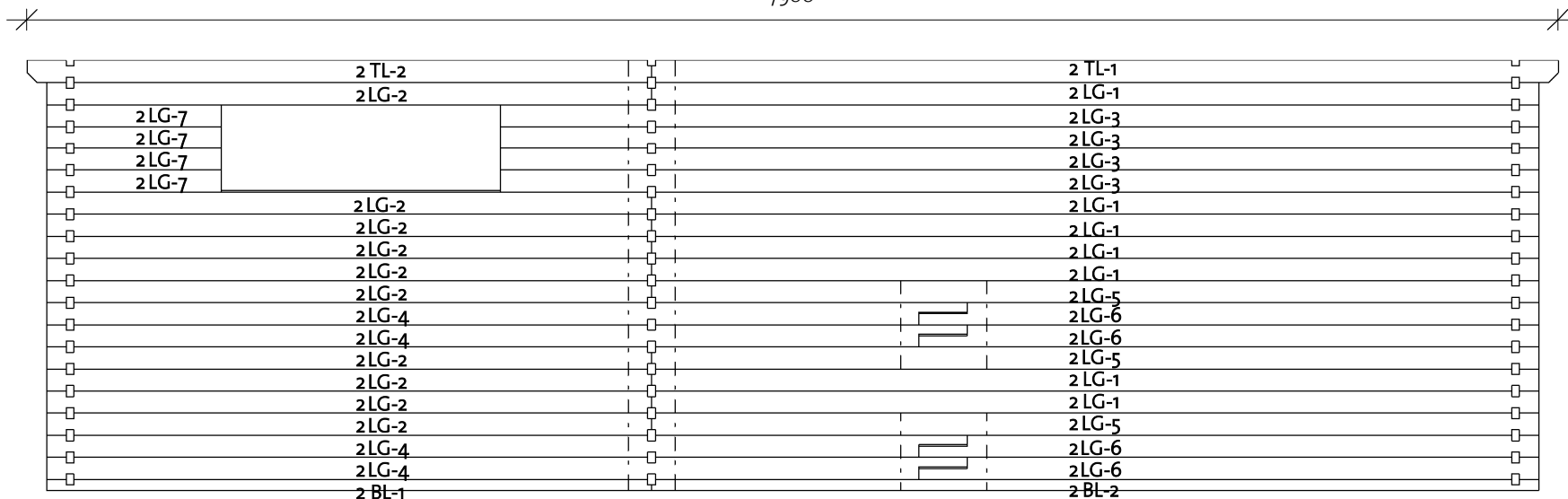

9207201_230113

SH Oriental 5 40 Kindergarten (750x300)

Wall B

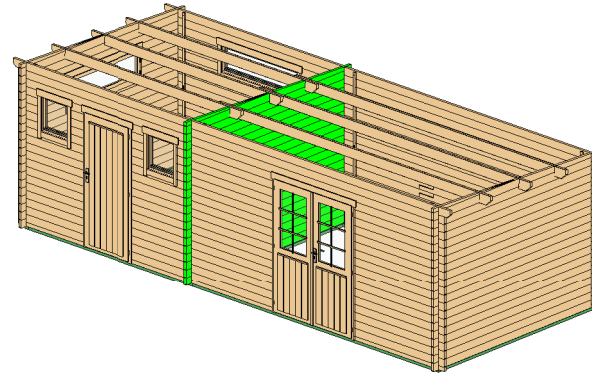

Wall B			
Mark	Profile	Count	Cut Length

BLG-1*	40X114	1	1583
BLG-2*	40X114	1	3200
BLG-3*	40X114	1	3200
BLG-4	40X114	18	3200

* Gable - delivered premounted

BLG-1

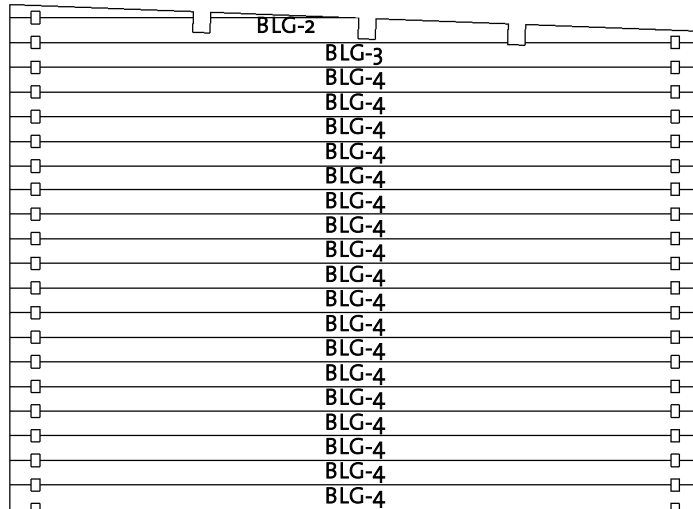



Log Profile Wall B	
Profile	Profile

40X114	
--------	--

SH Oriental 5 40 Kindergarten (750x300)

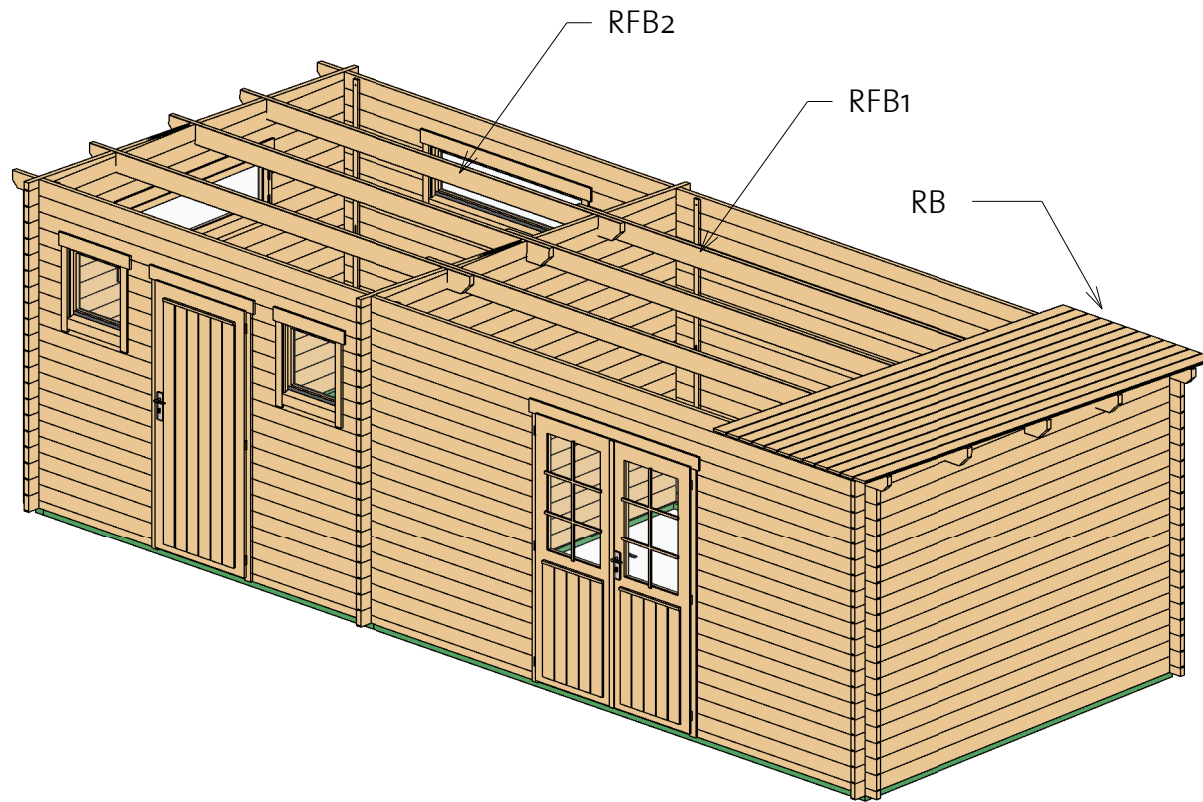
Roof 1



Roof				
Mark	Type	Profile	Count	Length
RB	17x114		71	3402
RFB1	Beam 40x143		3	4900
RFB2	Beam 40x143		3	3440

SH Oriental 5 40 Kindergarten (750x300)

Roof 2

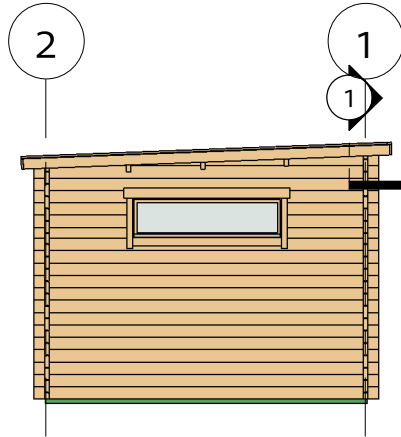

① Roof reinforcement 1

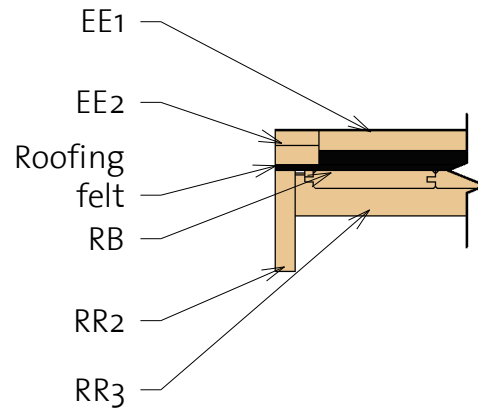

② Roof Reinforcement 2

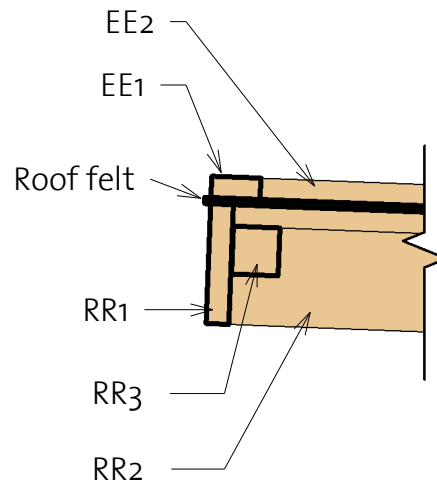
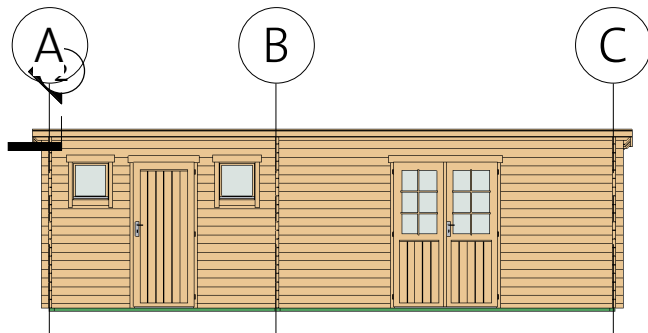

Fascia Schedule

Mark	Type	Profile	Count	Length
EE1	Eave Edging 18x40		2	3968
EE2	Eave Edging 18x40		2	3398
RR1	Roof reinforcement 18x95		4	3968
RR2	Roof reinforcement 18x95		2	3402
RR3	Roof reinforcement 38x38		4	3968

SH Oriental 5 40 Kindergarten (750x300)

Extras

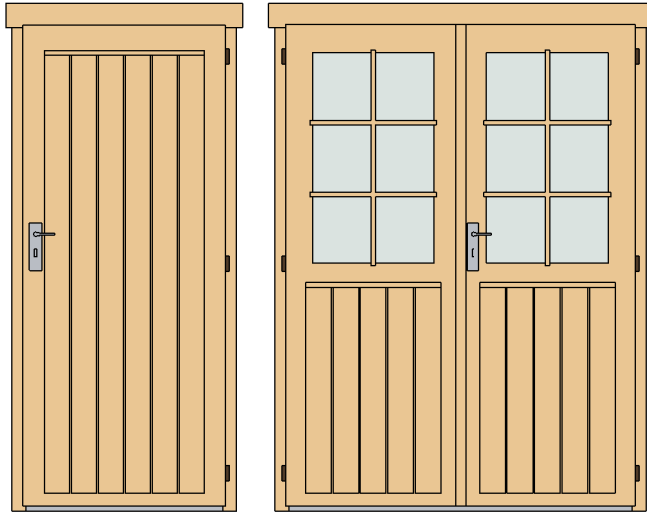

Door Schedule				
Mark	Type	Width	Height	Count

CD7R	Classic door 7, wood right	840	1955	1
CDD1R	Classic double door 1 right	1425	1955	1

DCB6	Door Crossbar 6	--	--	2
------	--------------------	----	----	---

Fasteners & Extras		
Name	Type	Count

Hitblock	300-400 mm	
Bolts	M8 x 70	18
Screws	5,0 x 70	28
Dowels	16,0 x 150	52
Screws	6,0 x 140	68
Screws	4,0 x 40	510

Window Schedule				
Mark	Type	Width	Height	Count

CW12R	Classic window 12, full glass right	540	540	2
CW20R	Classic window 20 right	1435	420	2

WCB6	Windows Crossbar 6 optional	--	--	2
------	-----------------------------------	----	----	---

Type	Count	Length
------	-------	--------

Windboard 18x40	3	2200
Windboard 18x40	3	2300

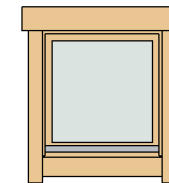

- * Windows intended for tilt opening only!
- * Fenster zur Eröffnung nur zum Kippen vorgesehen!
- * Aknad on ette nähtud ainult kaldu avamiseks!

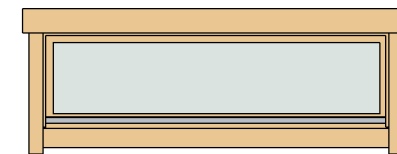

SH Oriental 5 40 Kindergarten (750x300)

List of all items 1



Impregnated foundation beams

Mark	Type	Profile	Count	Length
------	------	---------	-------	--------

IFB1	IFB 70x40		2	4370
IFB2	IFB 70x40		2	2910
IFB3	IFB 70x40		3	2990





Roof

Mark	Type	Profile	Count	Length
------	------	---------	-------	--------

RB	17x114		71	3402
RFB1	Beam 40x143		3	4900
RFB2	Beam 40x143		3	3440

Fascia Schedule

Mark	Type	Profile	Count	Length
------	------	---------	-------	--------

EE1	Eave Edging 18x40		2	3968
EE2	Eave Edging 18x40		2	3398
RR1	Roof reinforcement 18x95		4	3968
RR2	Roof reinforcement 18x95		2	3402
RR3	Roof reinforcement 38x38		4	3968

SH Oriental 5 40 Kindergarten (750x300)

List of all items 2

Wall 1			
Mark	Profile	Count	Cut Length

1BL-1	40X57	1	1195
1BL-2	40X57	1	2585
1BL-3	40X57	1	1630
1LG-1	40X114	2	4580
1LG-2	40X114	2	3120
1LG-3	40X114	17	1630
1LG-4	40X114	10	271
1LG-5	40X114	5	380
1LG-6	40X114	12	1195
1LG-7	40X114	12	2585
1LG-8	40X114	2	1770
1LG-9	40X114	3	1770
1TL-1	40X114	1	4680
1TL-2	40X114	1	3220

Wall B			
Mark	Profile	Count	Cut Length

BLG-1*	40X114	1	1583
BLG-2*	40X114	1	3200
BLG-3*	40X114	1	3200
BLG-4	40X114	18	3200

Wall C			
Mark	Profile	Count	Cut Length

CLG-1*	40X114	1	1583
CLG-2*	40X114	1	3200
CLG-3*	40X114	1	3200
CLG-4	40X114	18	3200

Wall 2			
Mark	Profile	Count	Cut Length



2BL-1	40X57	1	3120
2BL-2	40X57	1	4580
2LG-1	40X114	7	4580
2LG-2	40X114	10	3120
2LG-3	40X114	4	5358
2LG-4	40X114	4	4750
2LG-5	40X114	3	4580
2LG-6	40X114	4	3200
2LG-7	40X114	4	898
2TL-1	40X114	1	4680
2TL-2	40X114	1	3220

Wall A			
Mark	Profile	Count	Cut Length

ALG-1*	40X114	1	1583
ALG-2*	40X114	1	3200
ALG-3*	40X114	1	3200
ALG-4	40X114	8	878
ALG-5	40X114	14	3200

* Gable - delivered premounted

Log Profiles	
Profile	Profile

40X57	
40X114	

Log Profiles	
Profile	Profile

40X114	
--------	---

Windboard

① Windboard Assembly 1



② Windboard Assembly 2

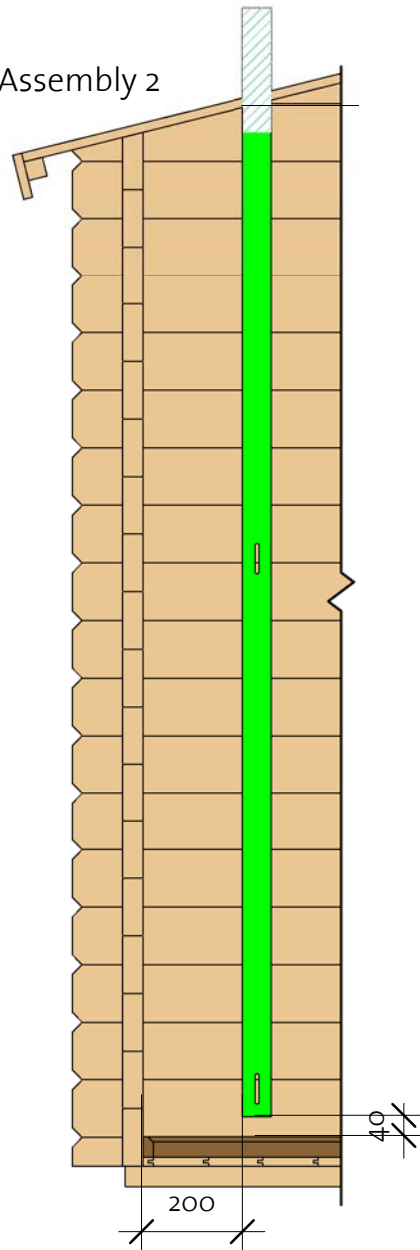

③ Windboard Assembly 3

