

# Placas II 40( 380x280)

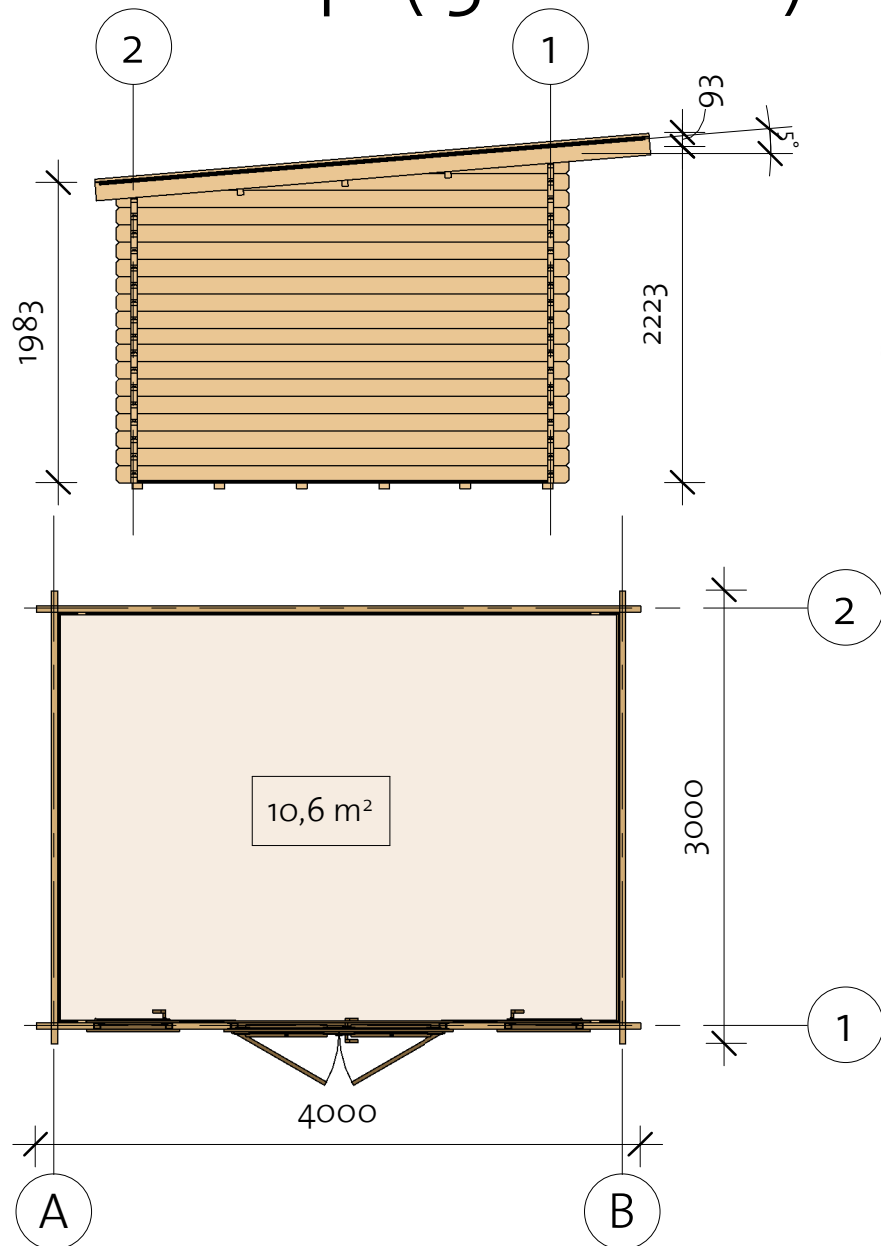

# Placas II 40( 380x280)

Foundation

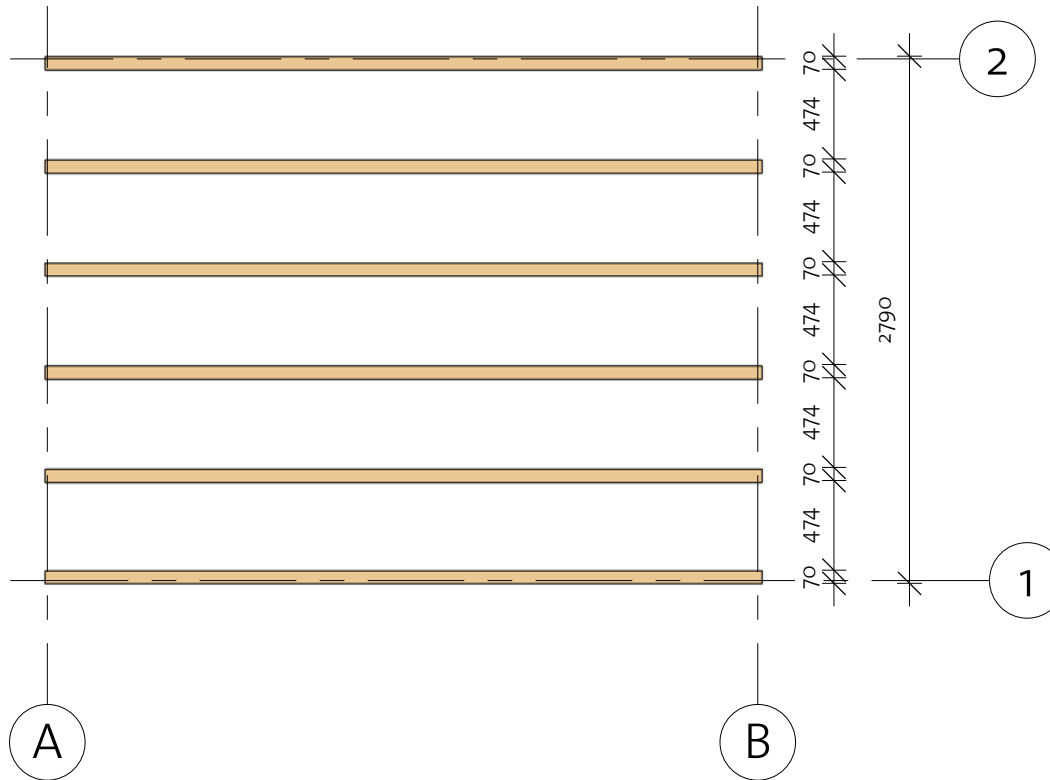

Impregnated foundation beams				
Mark	Type	Profile	Count	Length

IFB	IFB 70x40		6	3790
-----	--------------	---	---	------

# Placas II 40( 380x280)

Floor Plan

① Baseboard

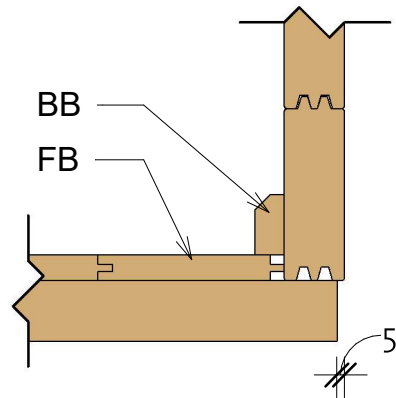

Floor Schedule

Mark	Type	Profile	Count	Length
------	------	---------	-------	--------

FB	FB 17x114		34	2717
----	-----------	---	----	------

BB1	BB 20x40		2	3800
BB2	BB 20x40		2	2800

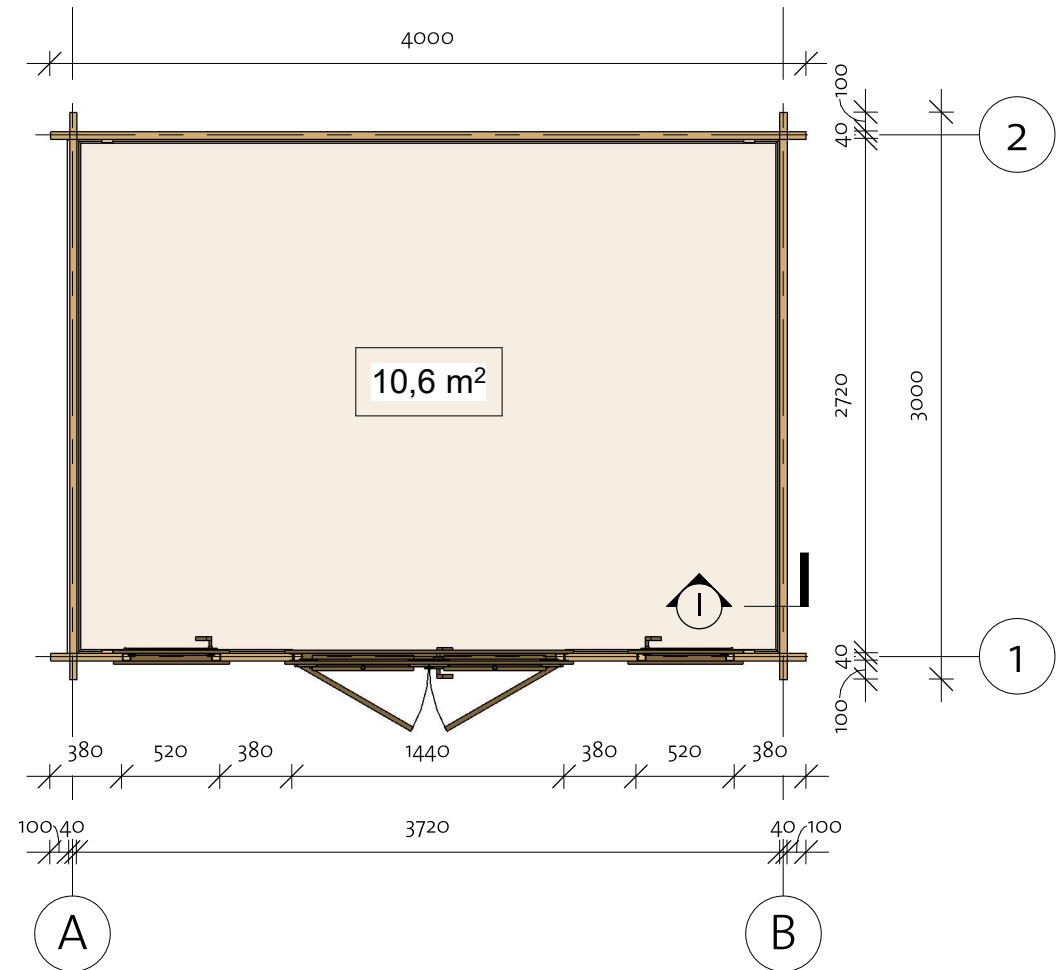

# Placas II 40(380x280)

Wall 1

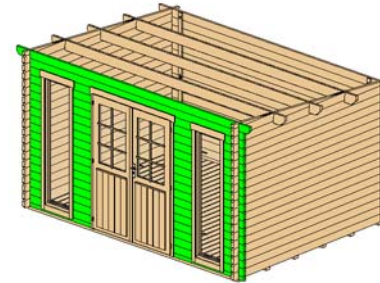

Wall 1			
Mark	Profile	Count	Cut Length

1BL-1	40x57	2	1280
1LG-1	40x114	34	380
1LG-2	40x114	34	380
1LG-3	40x114	1	4000
1TL-1	40x114	1	4200

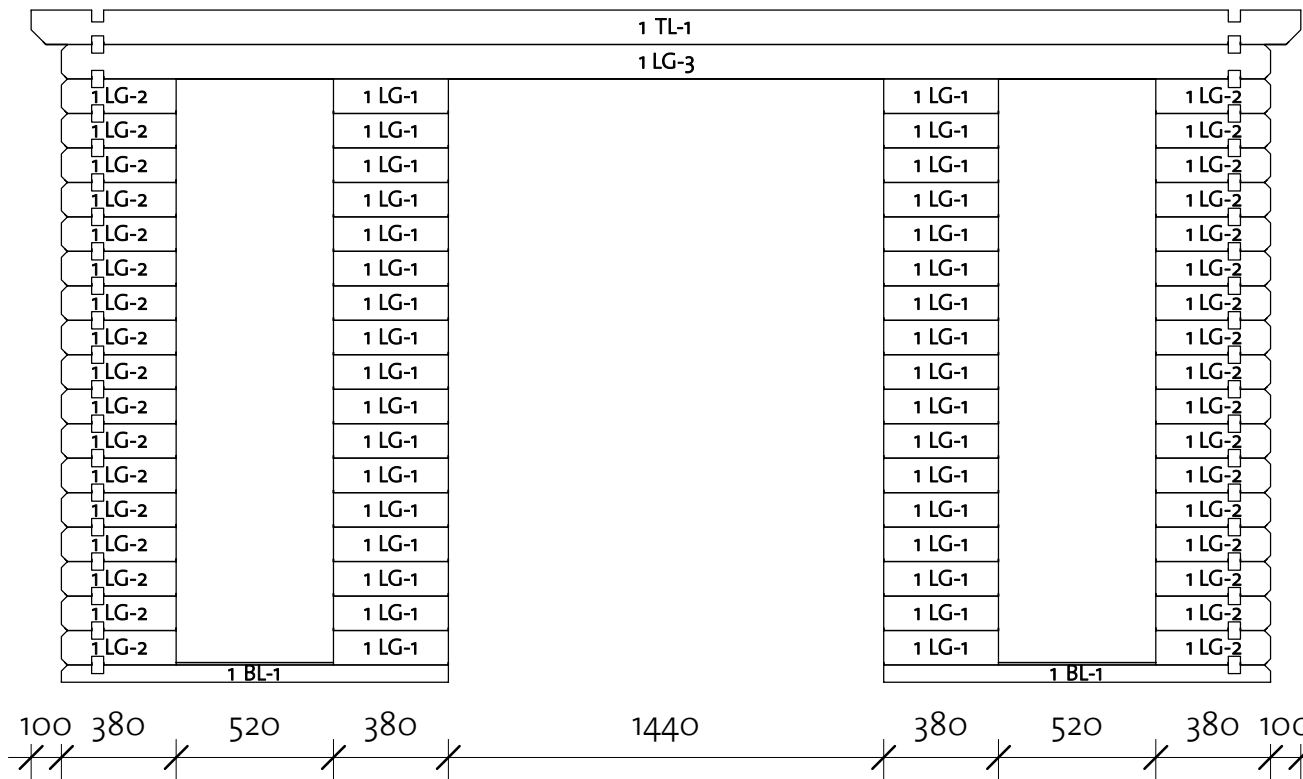

Log Profile Wall 1	
Profile	Profile

40x57	
40x114	
40x114	

# Placas II 40(380x280)

Wall 2

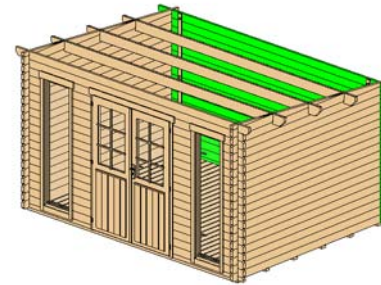

Wall 2			
Mark	Profile	Count	Cut Length

2BL-1	40X57	1	4000
2LG-1	40X114	16	4000
2TL-1	40X114	1	4200

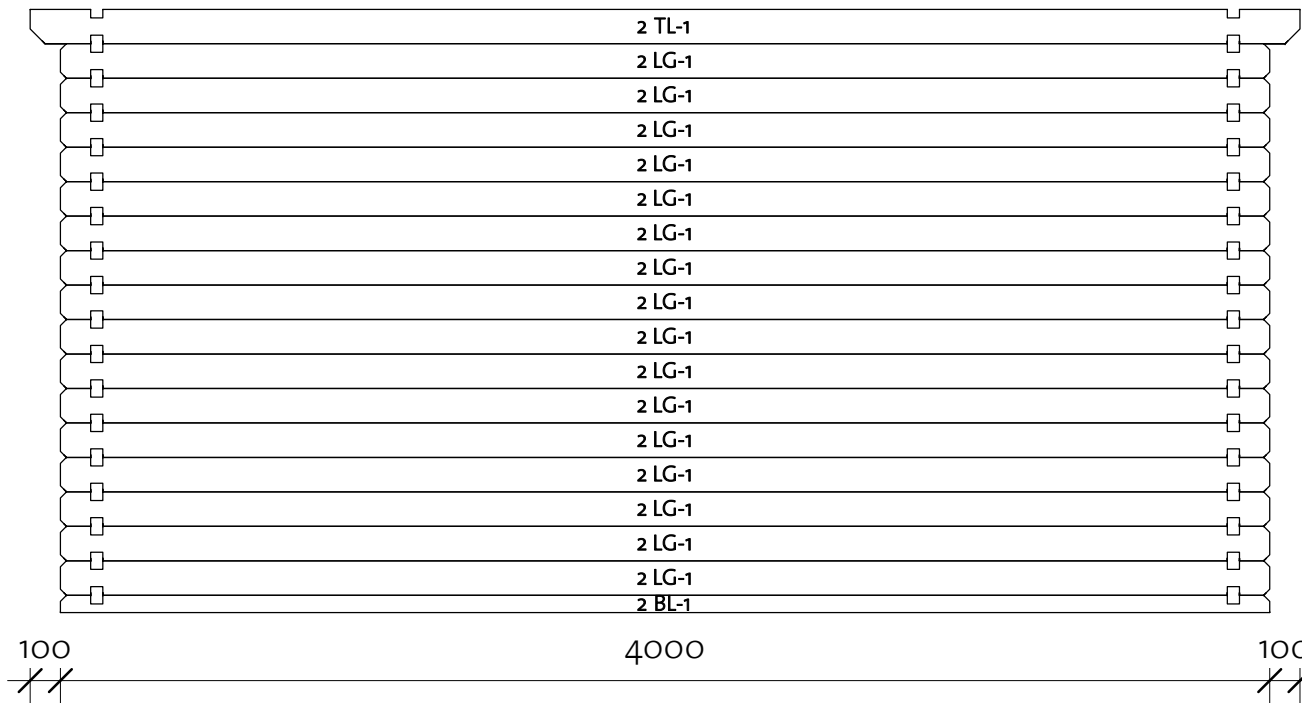

Log Profile Wall 2	
Profile	Profile

40X57	
40X114	
40X114	

# Placas II 40( 380x280)

Wall A

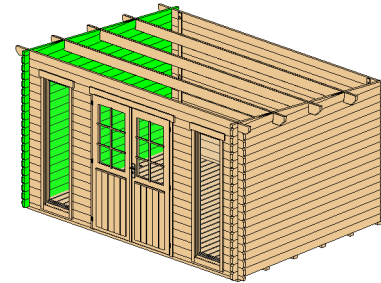

Wall A			
Mark	Profile	Count	Cut Length

ALG-1	40x114	17	3000
ALG-2*	40x114	1	3000
ALG-3*	40x114	1	2166
ALG-4*	40x114	1	787

\* Gable - delivered premounted

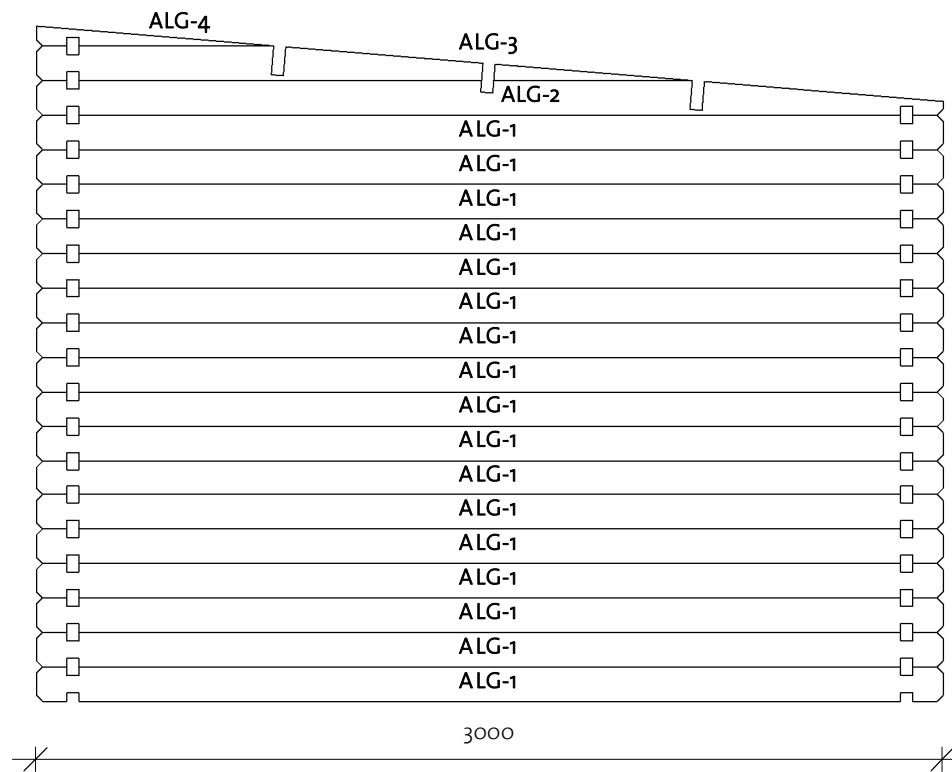

Log Profile Wall A	
Profile	Profile

40x114	
--------	--

# Placas II 40( 380x280)

Wall B

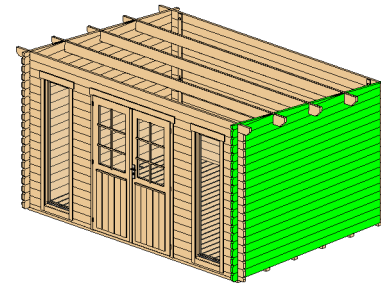

Wall B			
Mark	Profile	Count	Cut Length

BLG-1	40x114	17	3000
BLG-2*	40x114	1	3000
BLG-3*	40x114	1	2166
BLG-4*	40x114	1	787

\* Gable - delivered premounted

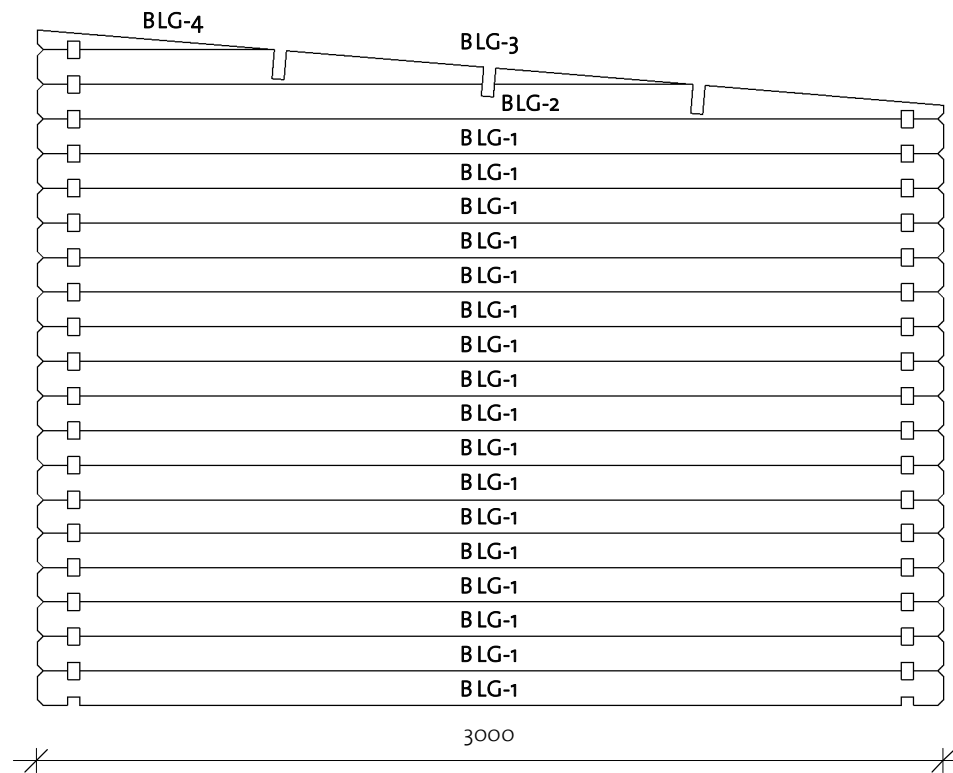



Log Profile Wall B	
Profile	Profile

40x114	
--------	--

# Placas II 40(380x280)

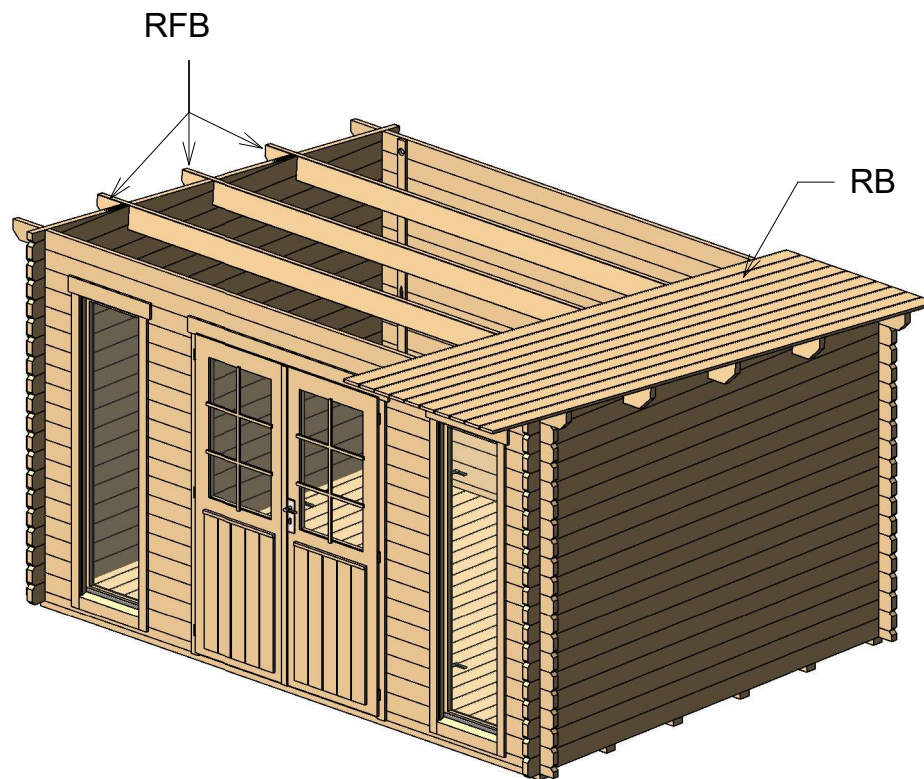
Roof 1



Roof				
Mark	Type	Profile	Count	Length
RFB	Beam 40x143		3	4200
RB	17x114		38	3620



# Placas II 40(380x280)

Roof 2

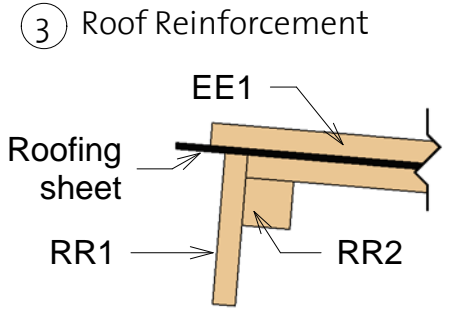
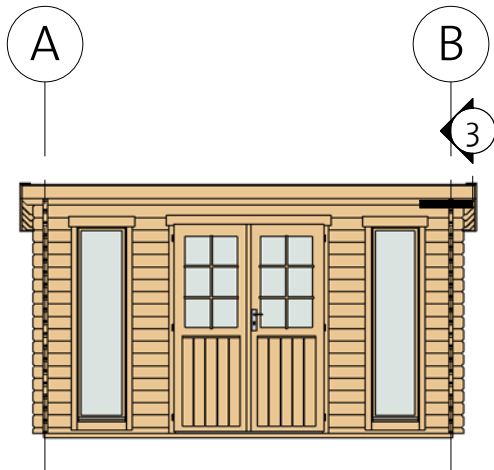
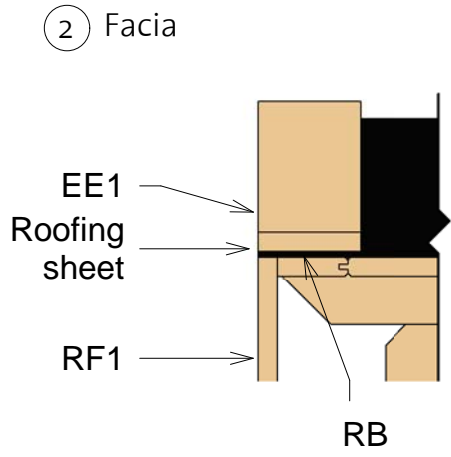
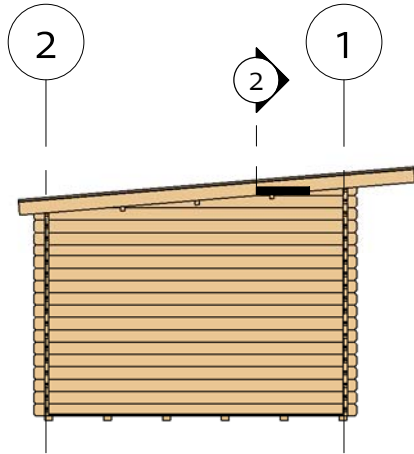

Fascia Schedule				
Mark	Type	Profile	Count	Length

RR1	Roof reinforcement 18x120		2	4200
RR2	Roof reinforcement 38x38		2	4200
RF1	Roof Fascia 18x120		2	3680
EE1	Eave Edging 18x95		2	3680

# Placas II 40( 380x280)

Extras

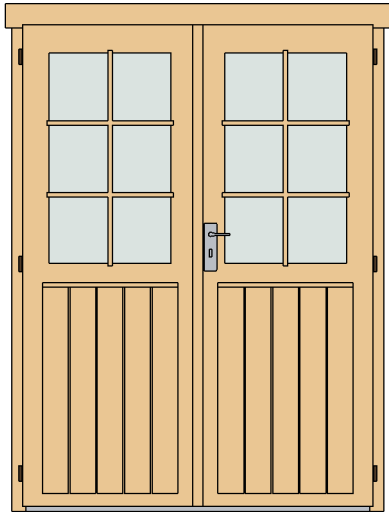

Door Schedule				
Mark	Type	Width	Height	Count
CDD1R	Classic double door 1 right	1425	1955	1
DCB6	Door Crossbar 6	--	--	2

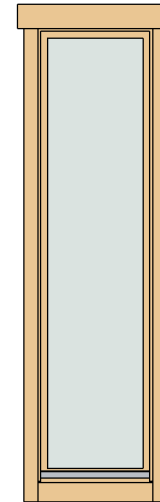

Window Schedule				
Mark	Type	Width	Height	Count
CW21R	Classic window 21 right	515	1890	2
WCB8	Windows Crossbar 8 optional	--	--	2

\* Windows intended for tilt opening only!

Fasteners & Extras		
Name	Type	Count

Hitblock	300-400 mm	
Bolts	M8 x 70	12
Screws	5,0 x 70	15
Nails	1,4 x 40	25
Screws	6,0 x 140	40
Screws	4,0 x 40	520



Type	Length	Count
Windboard 18x40	2200	4

# Placas II 40( 380x280)

## List of all items 1

### Impregnated foundation beams

Mark	Type	Profile	Count	Length
------	------	---------	-------	--------

IFB	IFB 70x40		6	3790
-----	--------------	---	---	------

### Floor Schedule

Mark	Type	Profile	Count	Length
------	------	---------	-------	--------

FB	FB 17x114		34	2717
----	-----------	---	----	------

BB1	BB 20x40		2	3800
-----	-------------	---	---	------

BB2	BB 20x40		2	2800
-----	-------------	--	---	------

### Roof

Mark	Type	Profile	Count	Length
------	------	---------	-------	--------

RFB	Beam 40x143		3	4200
-----	----------------	---	---	------

RB	17x114		38	3620
----	--------	---	----	------

### Fascia Schedule

Mark	Type	Profile	Count	Length
------	------	---------	-------	--------

RR1	Roof reinforcement 18x120		2	4200
-----	---------------------------------	---	---	------

RR2	Roof reinforcement 38x38		2	4200
-----	--------------------------------	---	---	------

RF1	Roof Fascia 18x120		2	3680
-----	-----------------------	---	---	------

EE1	Eave Edging 18x95		2	3680
-----	----------------------	---	---	------

# Placas II 40( 380x280)

## List of all items 2

Wall 1			
Mark	Profile	Count	Cut Length

1BL-1	40x57	2	1280
1LG-1	40x114	34	380
1LG-2	40x114	34	380
1LG-3	40x114	1	4000
1TL-1	40x114	1	4200

Wall 2			
Mark	Profile	Count	Cut Length

2BL-1	40x57	1	4000
2LG-1	40x114	16	4000
2TL-1	40x114	1	4200

Wall A			
Mark	Profile	Count	Cut Length



ALG-1	40x114	17	3000
ALG-2*	40x114	1	3000
ALG-3*	40x114	1	2166
ALG-4*	40x114	1	787

Wall B			
Mark	Profile	Count	Cut Length

BLG-1	40x114	17	3000
BLG-2*	40x114	1	3000
BLG-3*	40x114	1	2166
BLG-4*	40x114	1	787

\* Gable - delivered premounted

Log Profiles	
Profile	Profile

40x57	
40x114	

Log Profiles	
Profile	Profile

40x114	
--------	---