

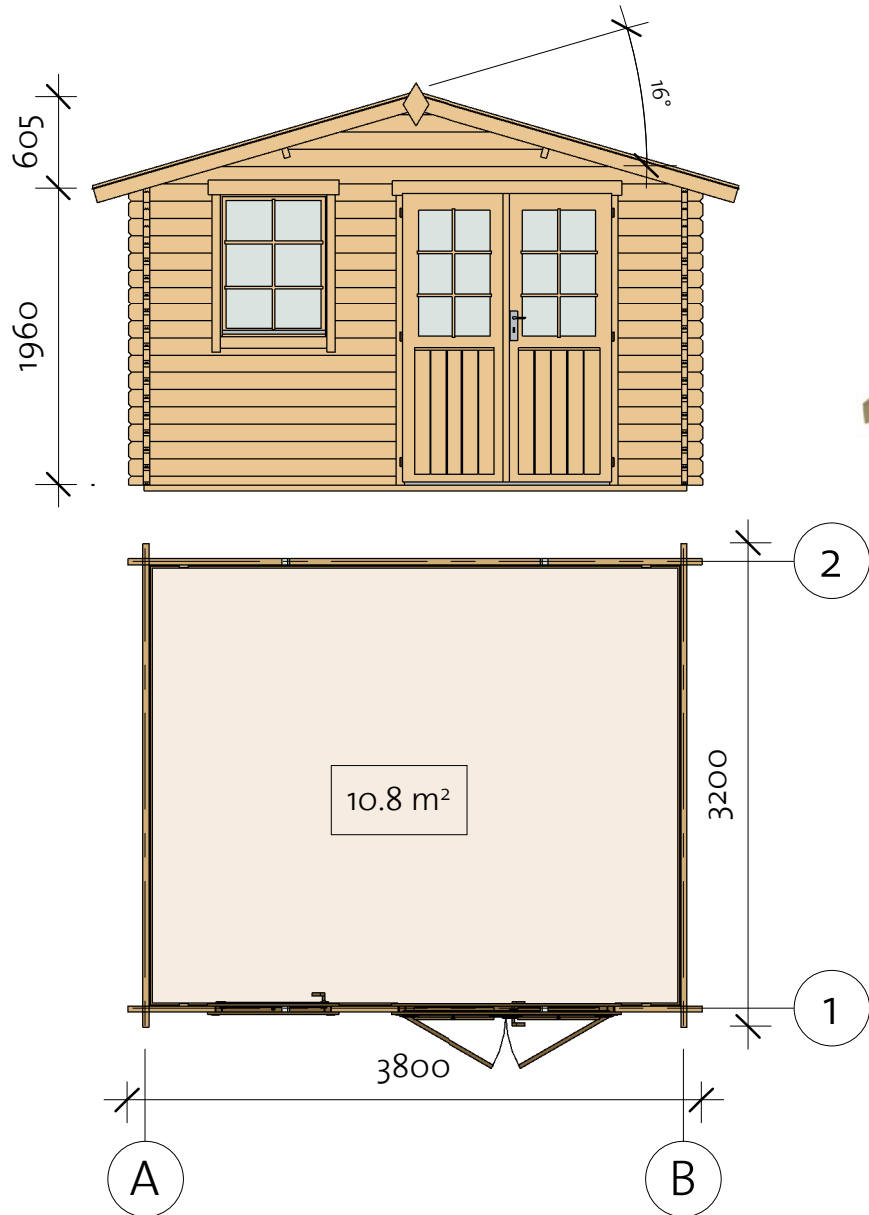

Brantevik I 40 (360x300)

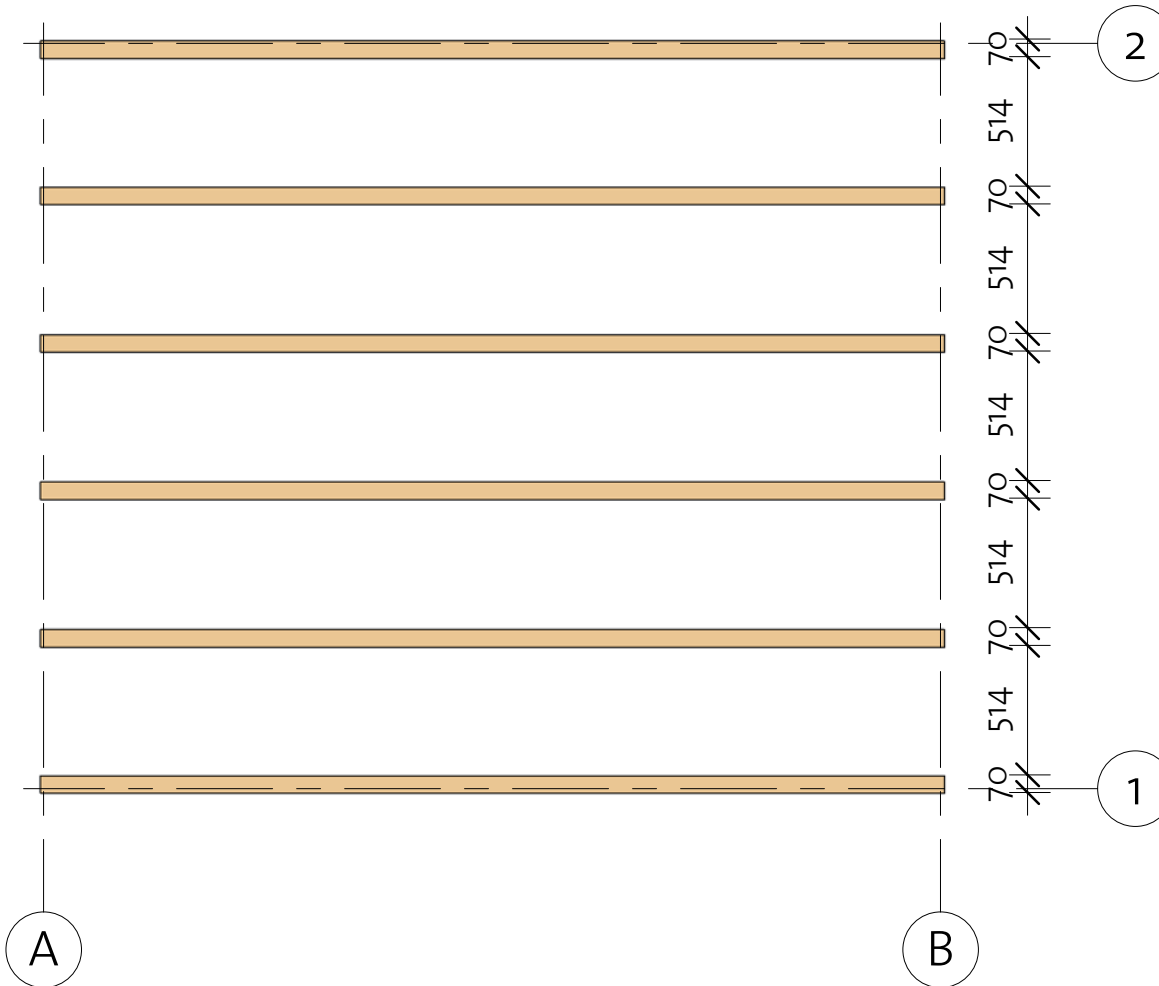

Brantevik I 40 (360x300)

Foundation



Impregnated foundation beams				
Mark	Type	Profile	Count	Length
IFB	IFB 40x70		6	3590

Brantevik I 40 (360x300)

Floor Plan

① Baseboard

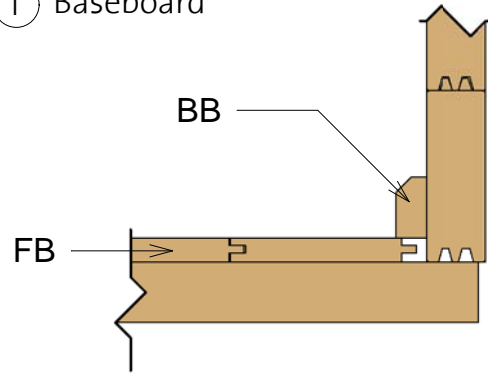

Floor Schedule

Mark	Type	Profile	Count	Length
------	------	---------	-------	--------

FB	FB 17x114		33	2915
----	-----------	--	----	------

BB1	BB 20x40		2	3600
BB2	BB 20x40		2	3000

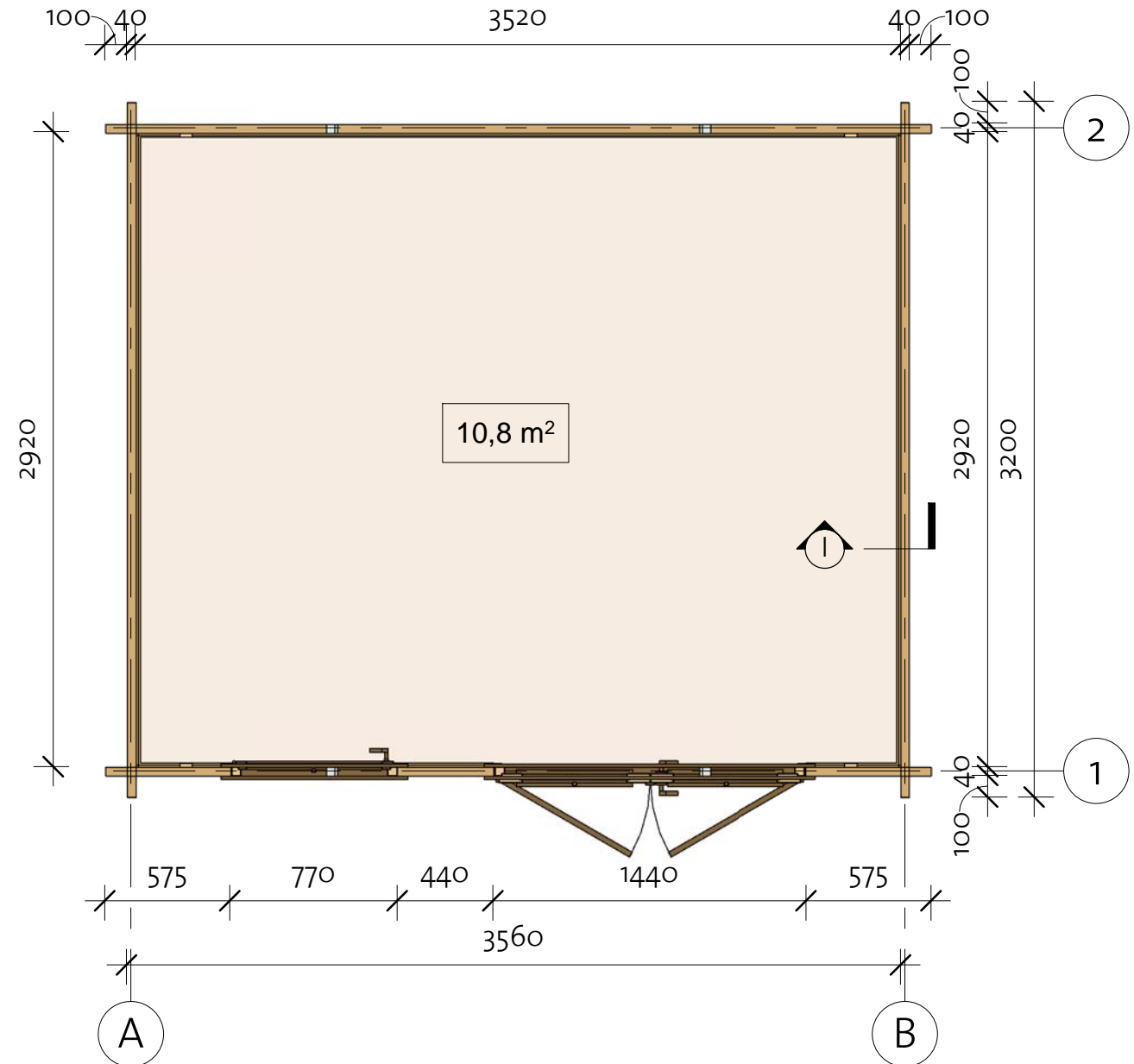

4200003_200129

Brantevik I 40 (360x300)

Wall 1

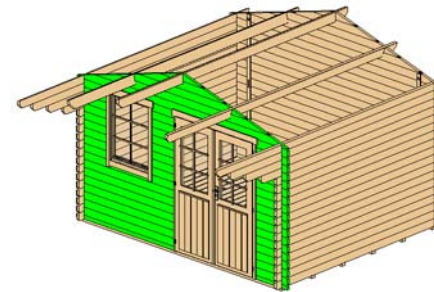

Wall 1

Mark	Profile	Count	Cut Length
------	---------	-------	------------

1BL 1	40x57	1	575
1BL 2	40x57	1	1785
1LG 1	40x114	9	440
1LG 2	40x114	26	575
1LG 3*	40x114	1	784
1LG 4*	40x114	1	1566
1LG 5	40x114	8	1785
1LG 6*	40x114	1	2347
1LG 7*	40x114	1	3129
1LG 8*	40x114	1	3794

*Gable-delivered premounted

Log Profile Wall 1

Profile	Profile
---------	---------

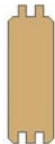
40x57	
40x114	

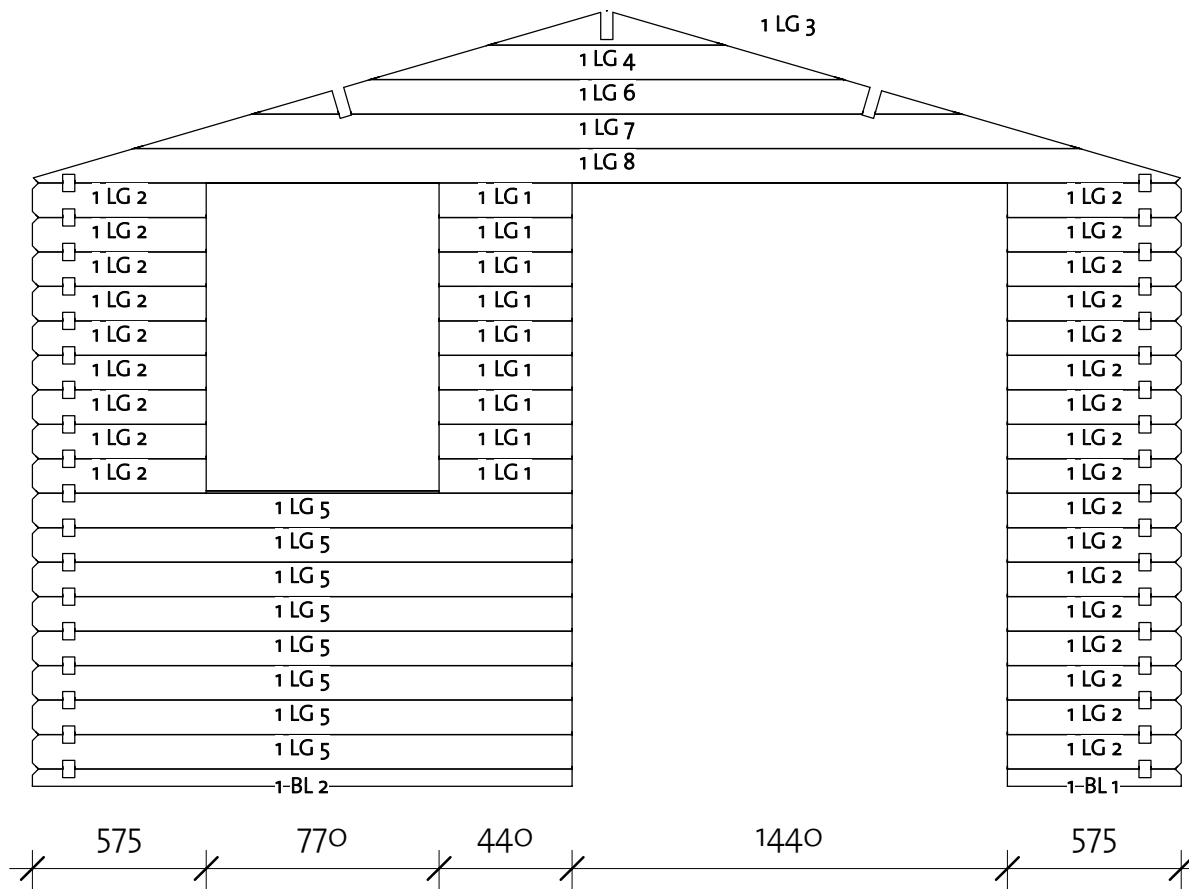

Brantevik I 40 (360x300)

Wall 2

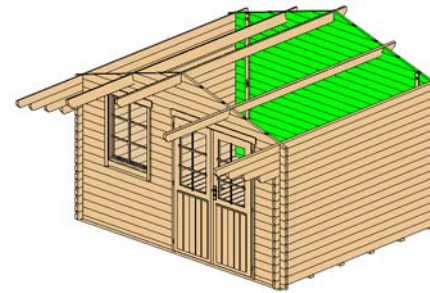

Wall 2			
Mark	Profile	Count	Cut Length

2BL 1	40x57	1	3800
2LG 1 *	40x114	1	784
2LG 2 *	40x114	1	1566
2LG 3 *	40x114	1	2347
2LG 4 *	40x114	1	3129
2LG 5 *	40x114	1	3794
2LG 6	40x114	17	3800

*Gable-delivered premounted

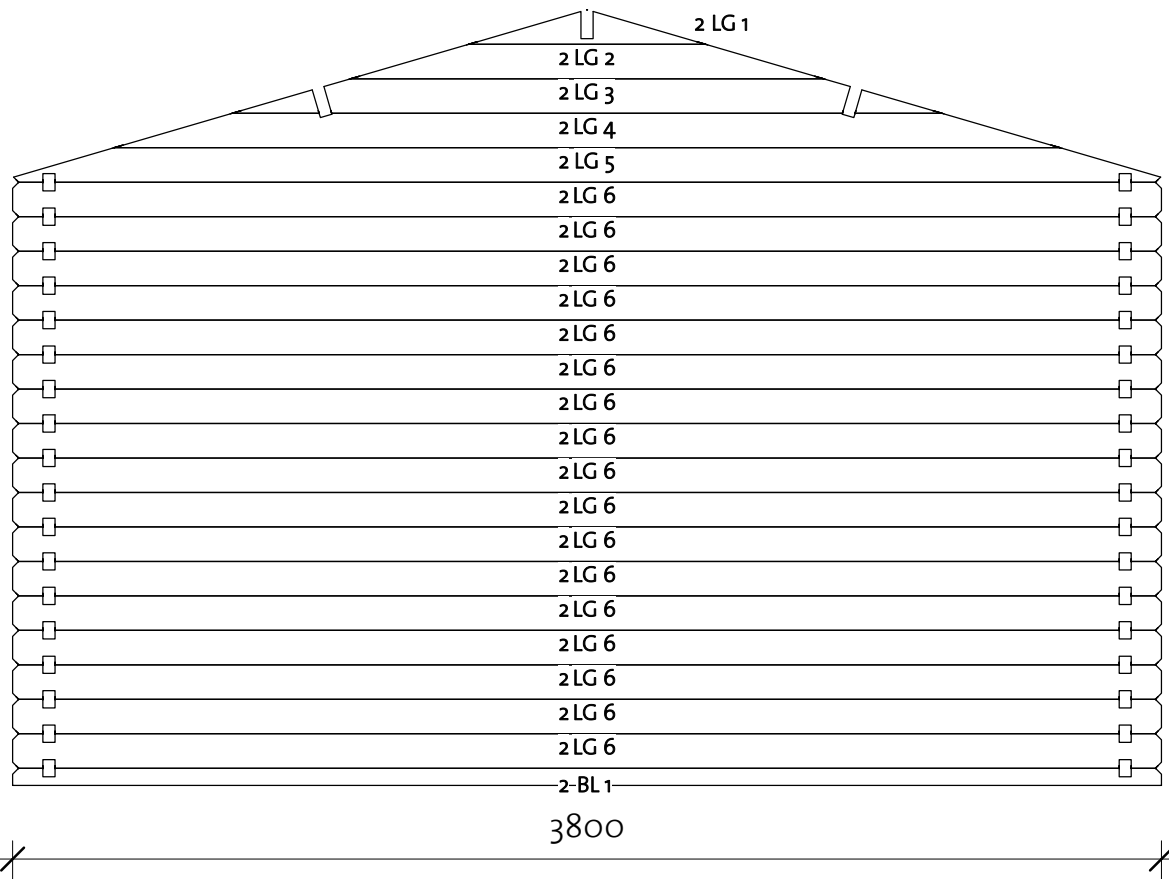

Log Profile Wall 2	
Profile	Profile

40x57	
40x114	

Brantevik I 40 (360x300)

Wall A

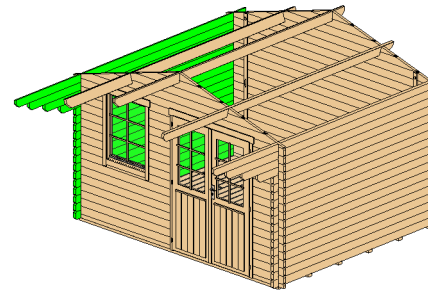

Wall A			
Mark	Profile	Count	Cut Length

ALG 1	40x114	14	3200
ALG 2	40x114	1	3500
ALG 3	40x114	1	3800
ALG 4	40x114	1	4100
ATL 1	40x114	1	4450

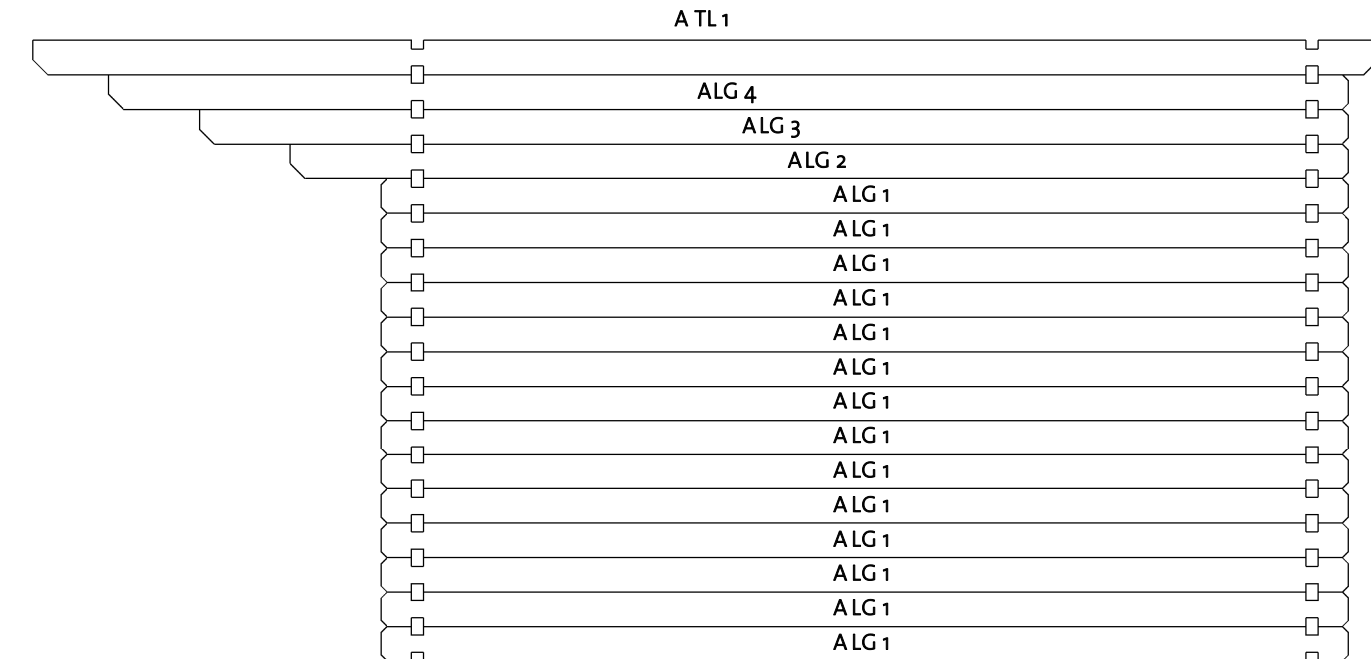

Log Profile Wall A	
Profile	Profile

40x114	
40x114	

Brantevik I 40 (360x300)

Wall B

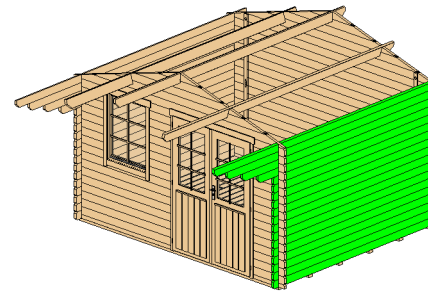

Wall B			
Mark	Profile	Count	Cut Length

BLG 1	40x114	14	3200
BLG 2	40x114	1	3500
BLG 3	40x114	1	3800
BLG 4	40x114	1	4100
BTL 1	40x114	1	4450

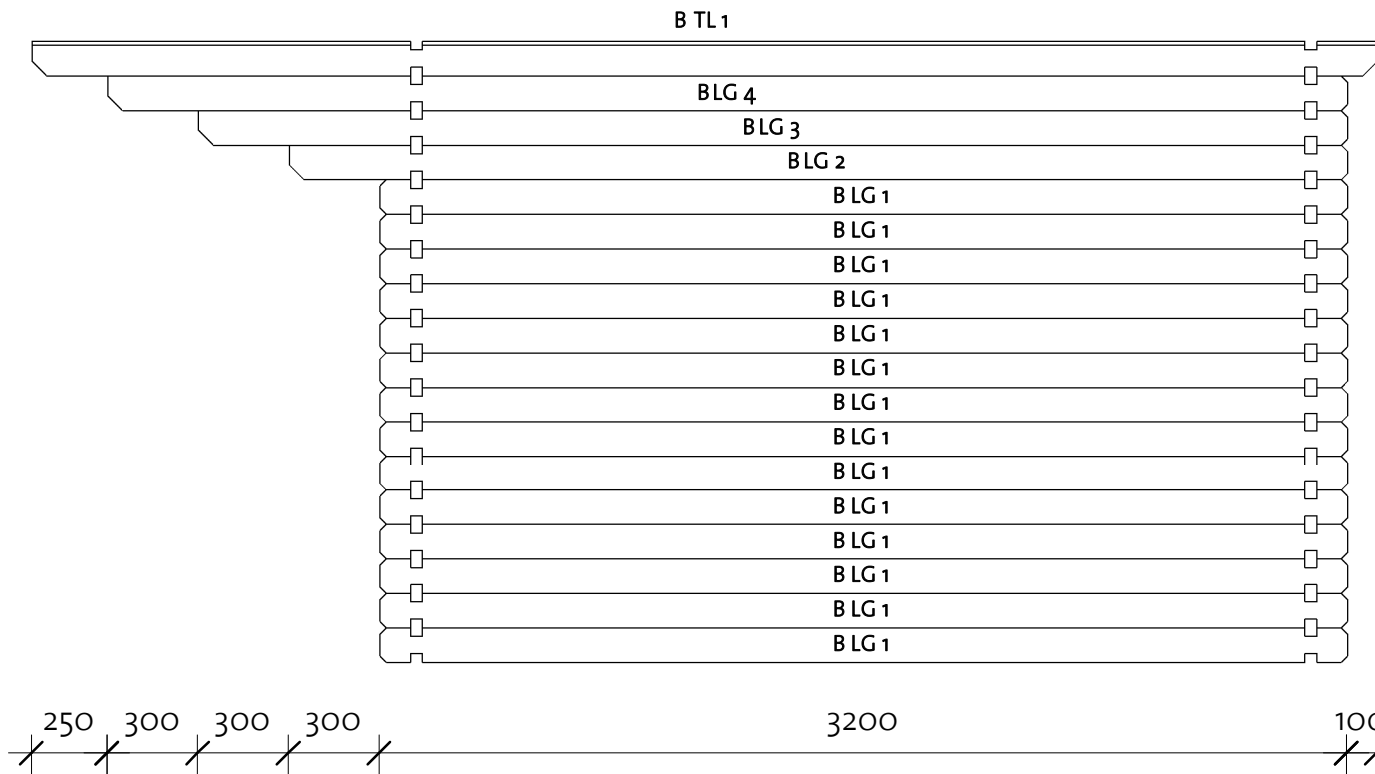





Log Profile Wall B	
Profile	Profile

40x114	
40x114	

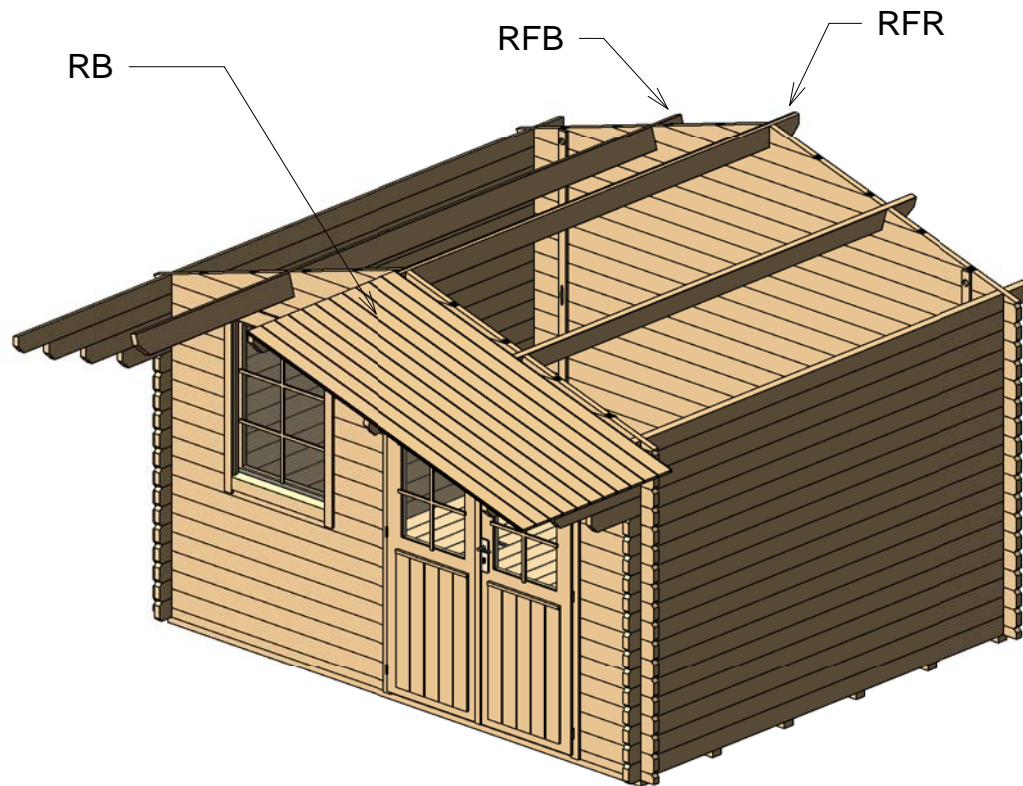
Brantevik I 40 (360x300)

Roof 1



Roof				
Mark	Type	Profile	Count	Length
RFR	Ridge 40X143		1	4450
RFB	Beam 40X143		2	4450
RB	Roofboard 17X114		84	2183

Brantevik I 40 (360x300)

Roof 2

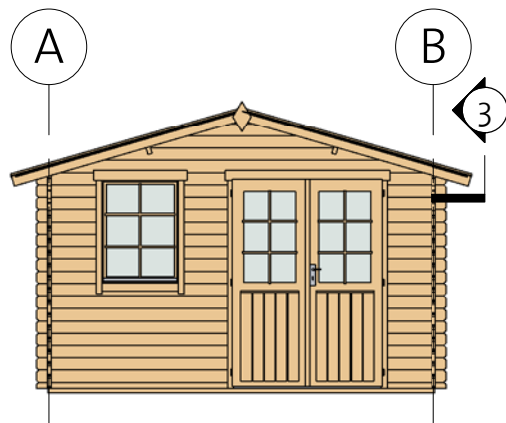
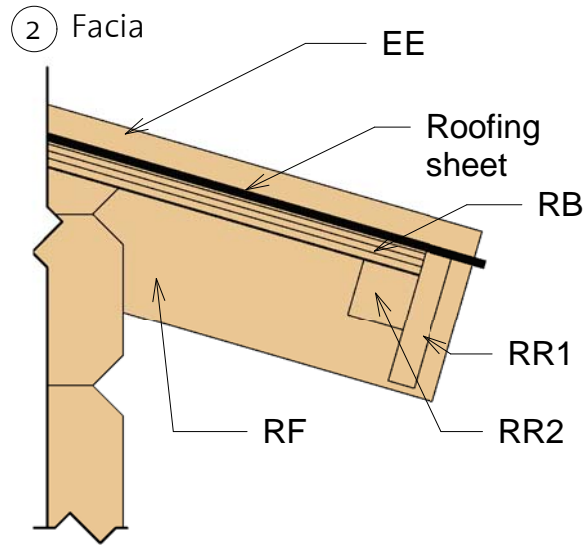
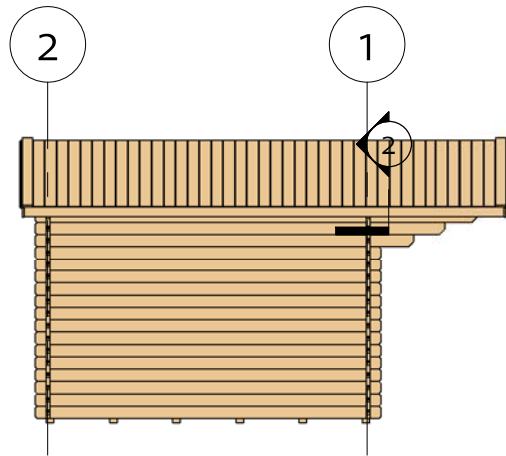

3 Roof Reinforcement

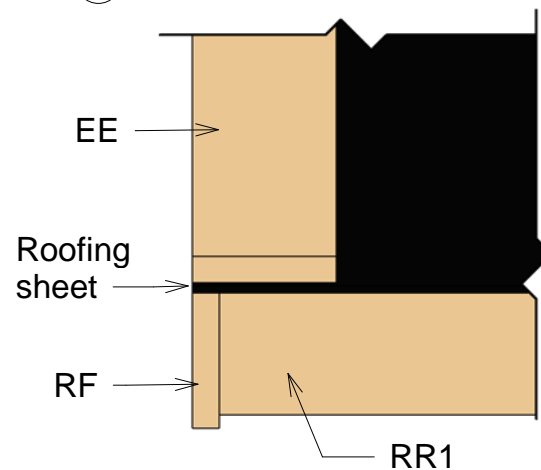

Fascia Schedule

Mark	Type	Profile	Count	Length
EE	Eave Edging 18x95		4	2220
RF	Roof Fascia 18x95		4	2220
RR1	Roof reinforcement 18x95		2	4450
RR2	Roof reinforcement 38x38		2	4450

Brantevik I 40 (360x300)

Extras



Door Schedule				
Model	Type	Width	Height	Count
CDD1R	Classic double door 1 right	1425	1955	1
DCB6	Door crossbar 6	--	--	2

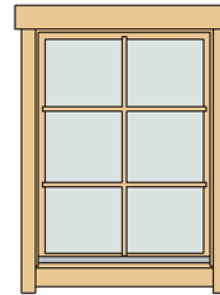

Window Schedule				
Model	Type	Width	Height	Count
CW1R	Classic window 1 right	765	990	1
WCB6	Window crossbar 6	--	--	1

Fasteners & Extras		
Name	Type	Count

Hitblock	300-400 mm	
Bolts	M8 x 70	12
Screws	5,0 x 70	15
Screws	6,0 x 140	30
Nails	1,4 x 40	30
Screws	4,0 x 40	85
Screws	4,0 x 50	480



Type	Count	Length
Windboard 18x40	4	2200



Family	Count
Romb	2

Brantevik I 40 (360x300)

List of all items 1

Impregnated foundation beams

Mark	Type	Profile	Count	Length
------	------	---------	-------	--------

IFB	IFB 40x70		6	3590
-----	--------------	---	---	------

Floor Schedule

Mark	Type	Profile	Count	Length
------	------	---------	-------	--------

FB	FB 17x114		33	2915
----	-----------	---	----	------

BB1	BB 20x40		2	3600
-----	-------------	---	---	------

BB2	BB 20x40		2	3000
-----	-------------	--	---	------

Roof

Mark	Type	Profile	Count	Length
------	------	---------	-------	--------

RFR	Ridge 40x143		1	4450
-----	-----------------	---	---	------

RFB	Beam 40x143		2	4450
-----	----------------	---	---	------

RB	Roofboard 17x114		84	2183
----	---------------------	---	----	------

Fascia Schedule

Mark	Type	Profile	Count	Length
------	------	---------	-------	--------

EE	Eave Edging 18x95		4	2220
----	----------------------	---	---	------

RF	Roof Fascia 18x95		4	2220
----	----------------------	---	---	------

RR1	Roof reinforcement 18x95		2	4450
-----	--------------------------------	---	---	------

RR2	Roof reinforcement 38x38		2	4450
-----	--------------------------------	---	---	------

Brantevik I 40 (360x300)

List of all items 2

Wall 1			
Mark	Profile	Count	Cut Length

1BL 1	40X57	1	575
1BL 2	40X57	1	1785
1LG 1	40X114	9	440
1LG 2	40X114	26	575
1LG 3*	40X114	1	784
1LG 4*	40X114	1	1566
1LG 5	40X114	8	1785
1LG 6*	40X114	1	2347
1LG 7*	40X114	1	3129
1LG 8*	40X114	1	3794

Wall 2			
Mark	Profile	Count	Cut Length

2BL 1	40X57	1	3800
2LG 1*	40X114	1	784
2LG 2*	40X114	1	1566
2LG 3*	40X114	1	2347
2LG 4*	40X114	1	3129
2LG 5*	40X114	1	3794
2LG 6	40X114	17	3800

*Gable-delivered premounted



Wall A			
Mark	Profile	Count	Cut Length

ALG 1	40X114	14	3200
ALG 2	40X114	1	3500
ALG 3	40X114	1	3800
ALG 4	40X114	1	4100
ATL 1	40X114	1	4450

Wall B			
Mark	Profile	Count	Cut Length

BLG 1	40X114	14	3200
BLG 2	40X114	1	3500
BLG 3	40X114	1	3800
BLG 4	40X114	1	4100
BTL 1	40X114	1	4450

Log Profiles	
Profile	Profile

40X114	
40X57	

Log Profiles	
Profile	Profile

40X114	
--------	---