

PREPARE THE **GROUND**, UNWRAP THE **PACKAGE**,
LAY OUT THE **COMPONENTS**, FIND THE **TOOLS**.

FREDRIKSTAD 40

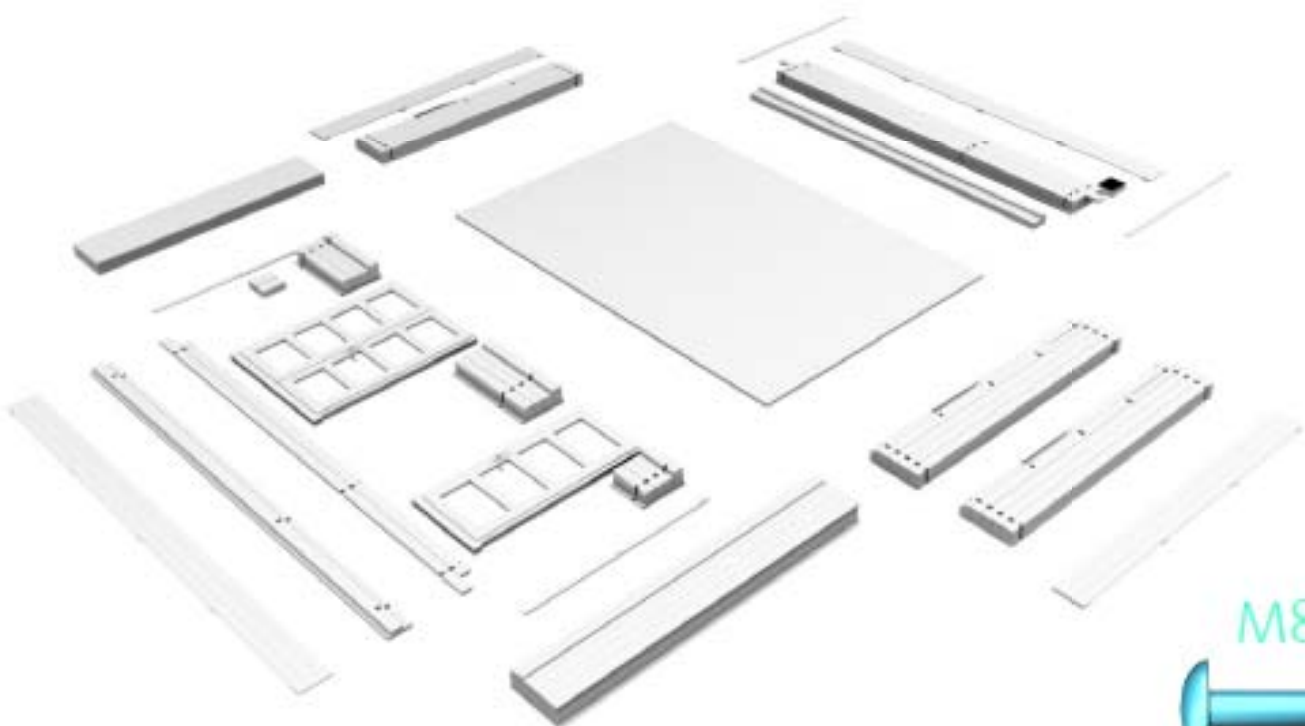

LAY OUT THE FOUNDATION BEAMS AND SQUARE IT BY MEASURING FROM CORNER TO CORNER.

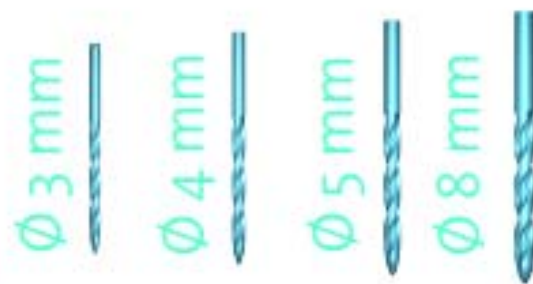
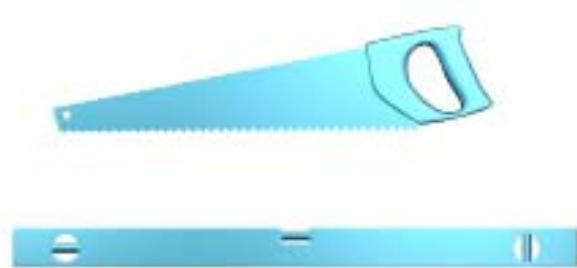
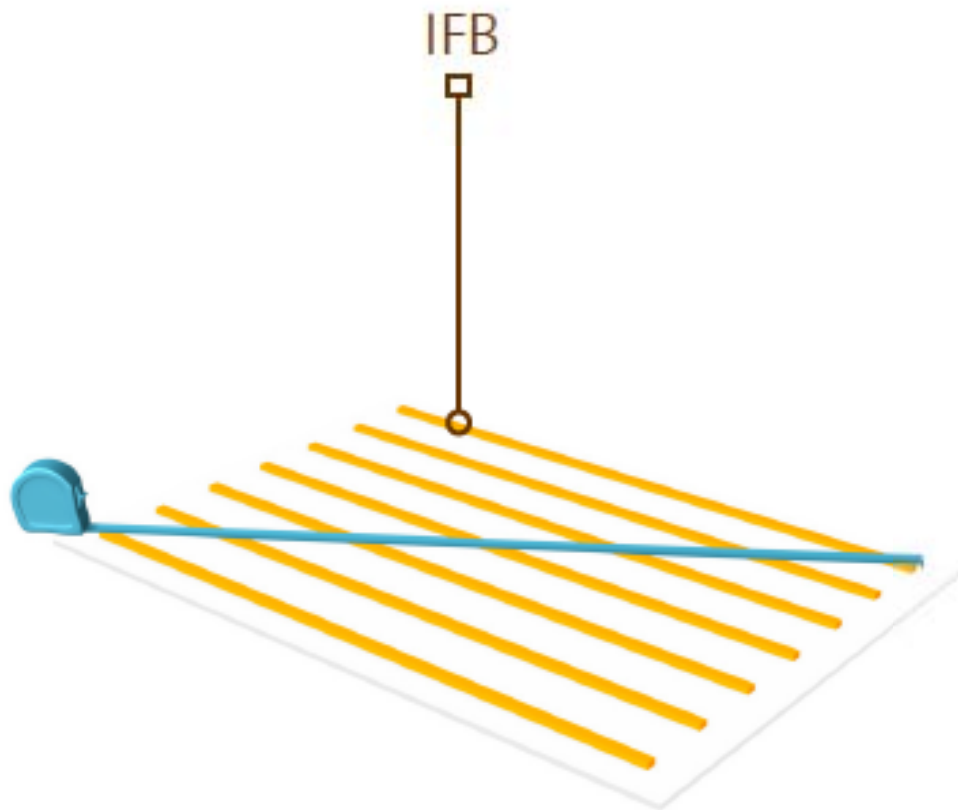
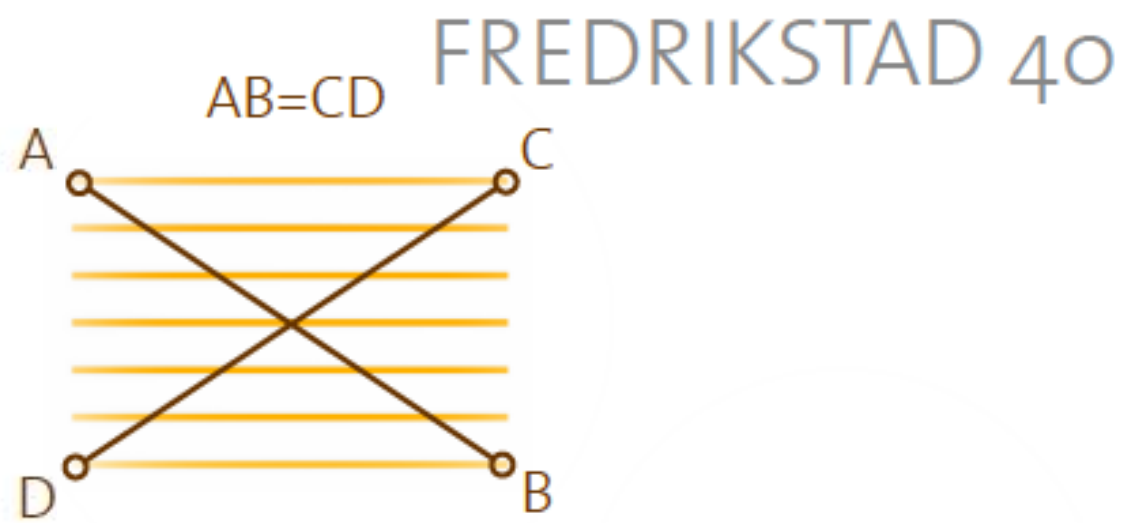

MAKE SURE THAT THE FOUNDATION IS INSTALLED ON A LEVEL SURFACE. CHECKING ALL DIRECTIONS, INCLUDING CORNER TO CORNER. 2%

LAY OUT THE **BOTTOM** LOGS,
ATTACH TO THE FOUNDATION.

FREDRIKSTAD 40

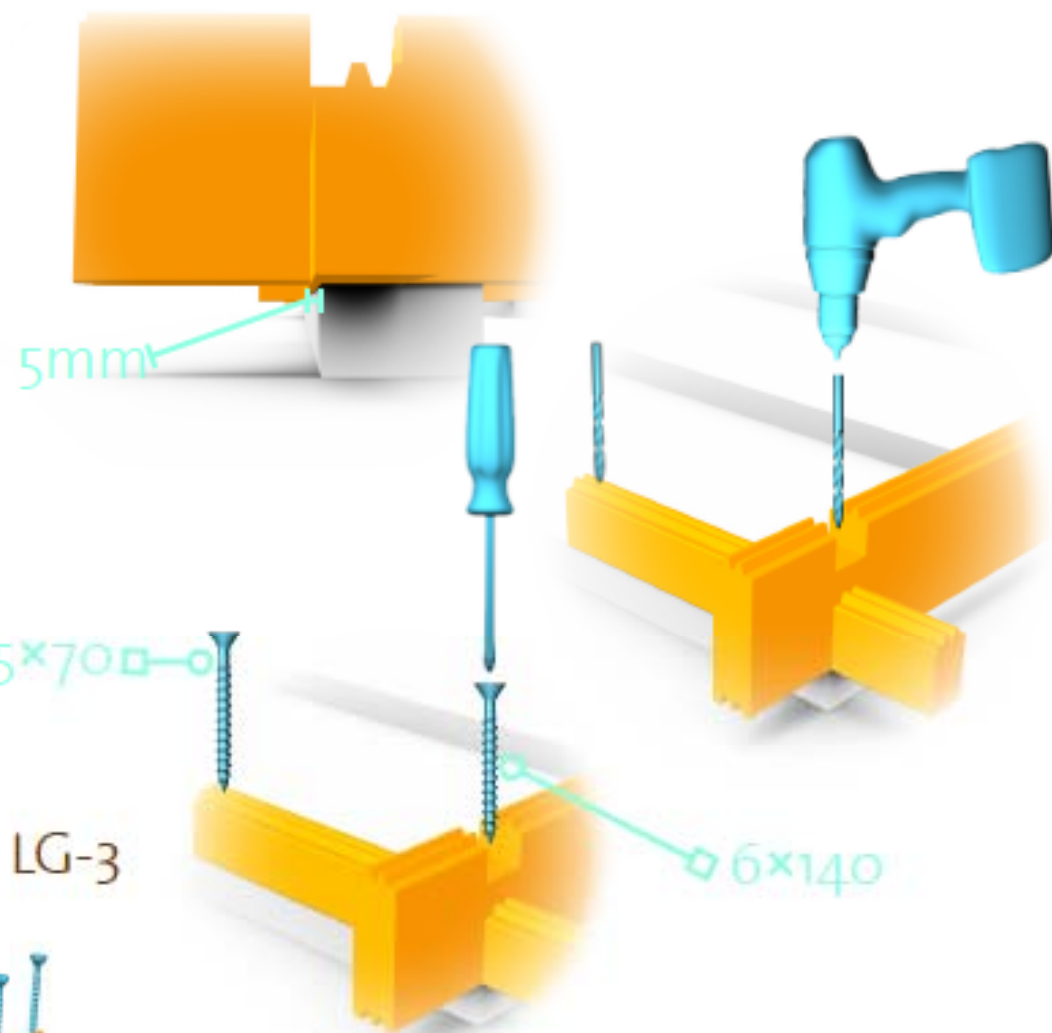
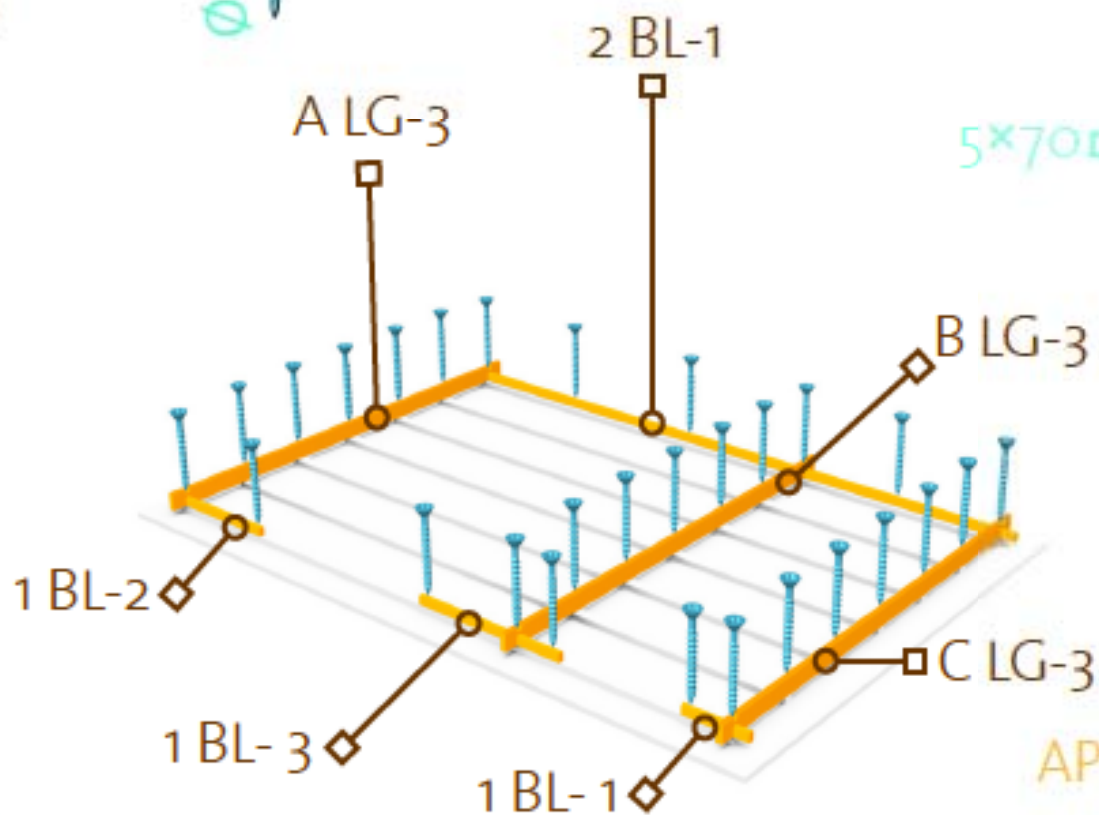
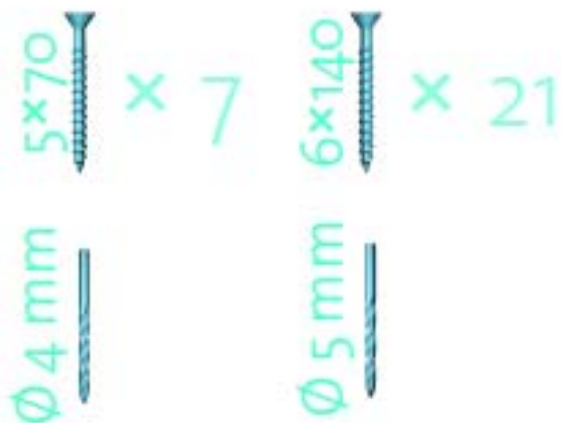

THE WALL **LOGS** WILL HANG OVER
THE FOUNDATION **BEAMS** BY
APPROXIMATELY 5MM. THIS OVERHANG
IS DESIGNED AS A RAIN DRIP. **5%**

ATTACH THE FIRST ROW OF
WALL LOGS INTO THE BOTTOM
LOGS WITH SCREWS.

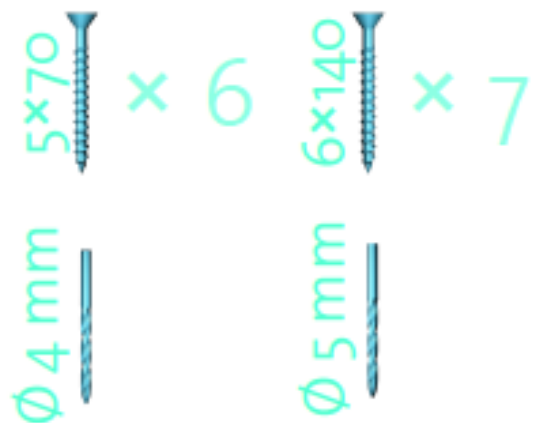

FREDRIKSTAD 40

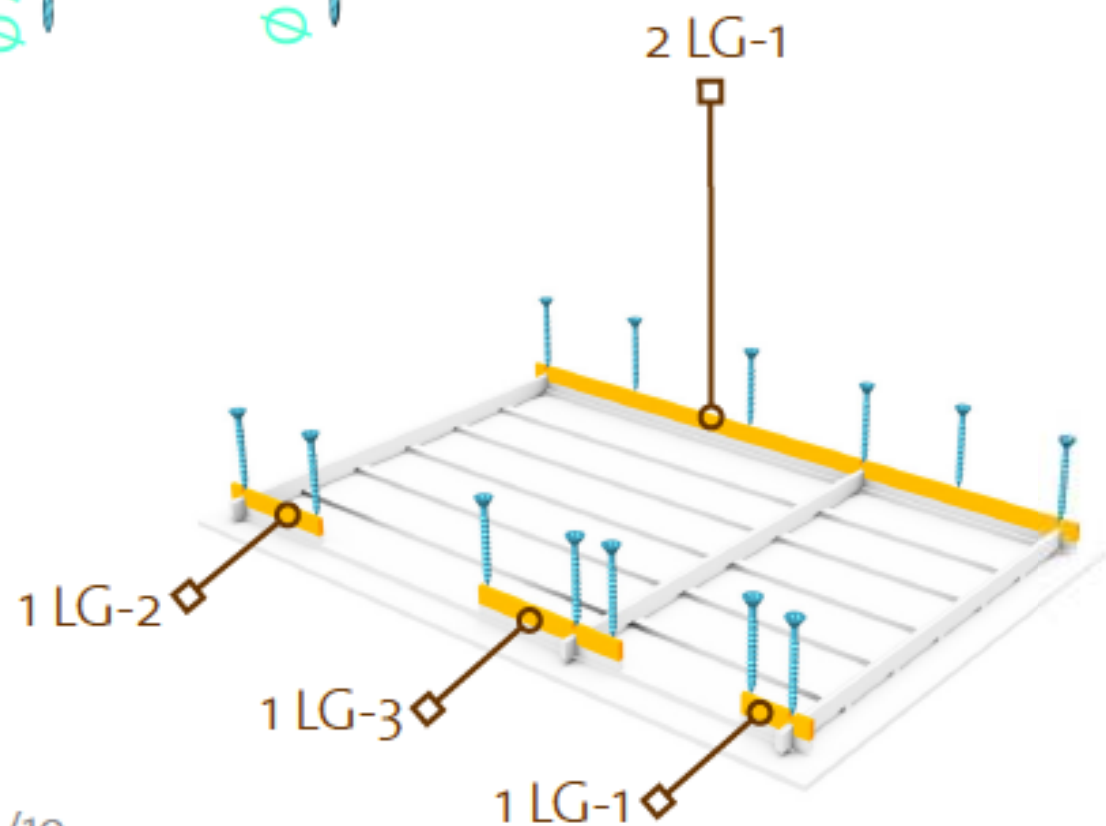
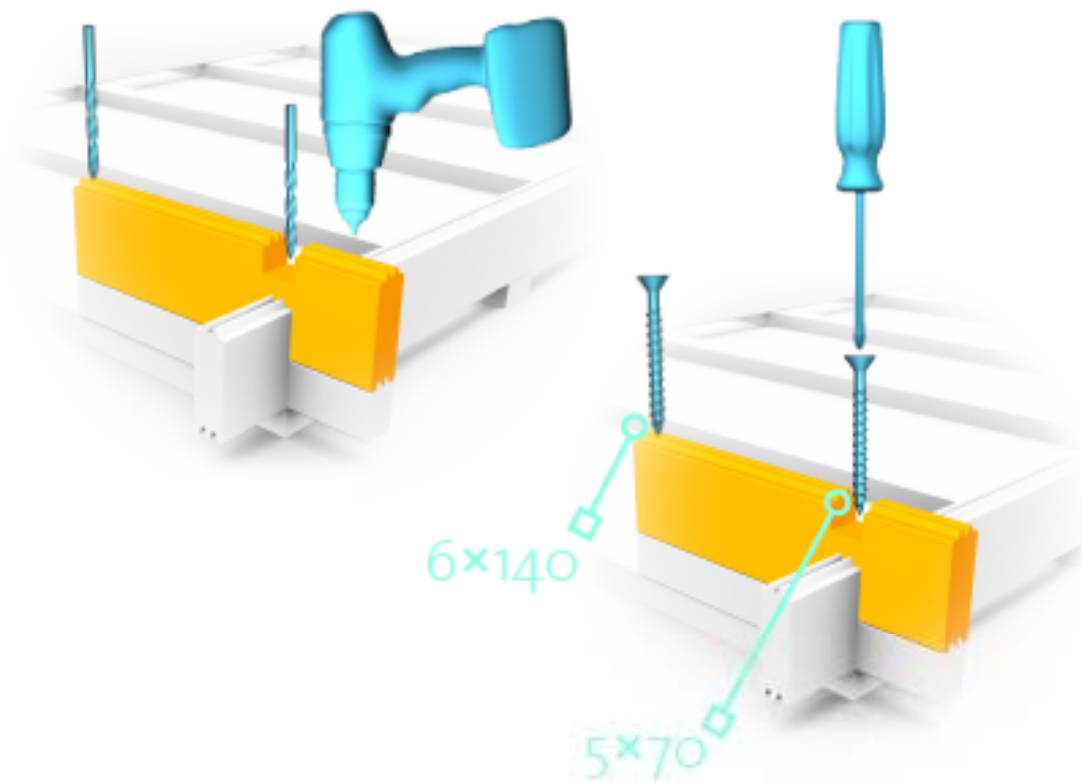

AFTER PLACING 3-4 ROWS OF WALL LOGS, TAP EACH WALL LOG IN PLACE USING A HAMMER AND THE HITBLOCK PROVIDED, TO TIGHTEN THE LOGS.

FREDRIKSTAD 40

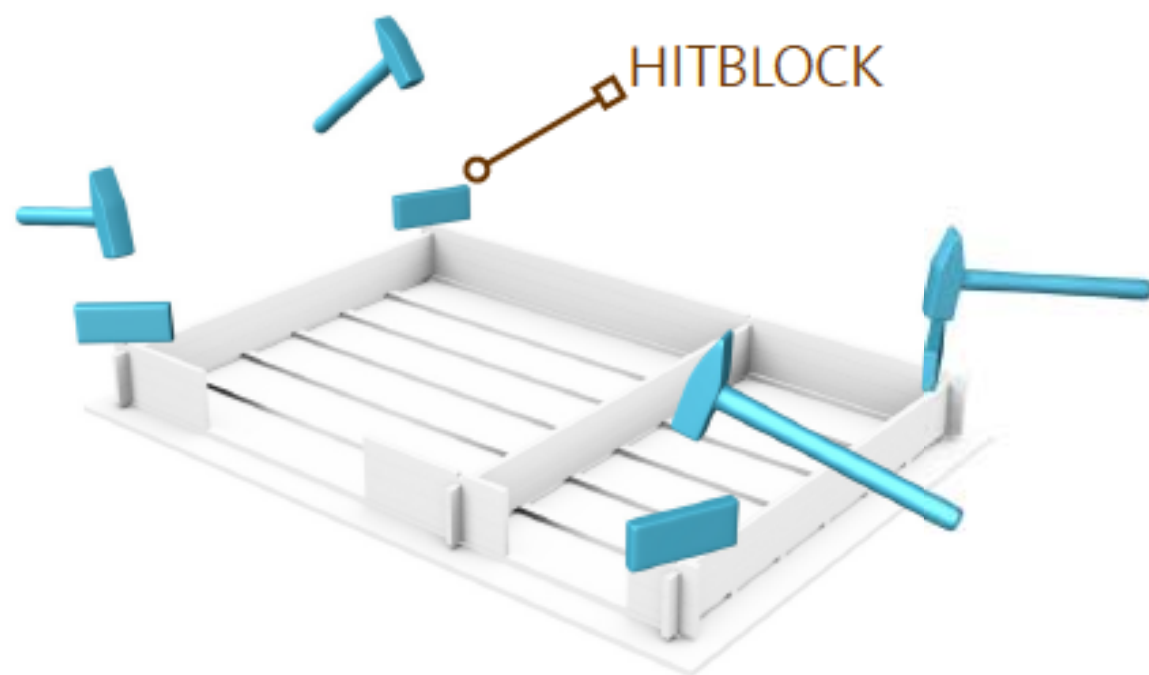

SLIDE THE **DOOR** IN,
ATTACH THE **HANDLE**.

FREDRIKSTAD 40

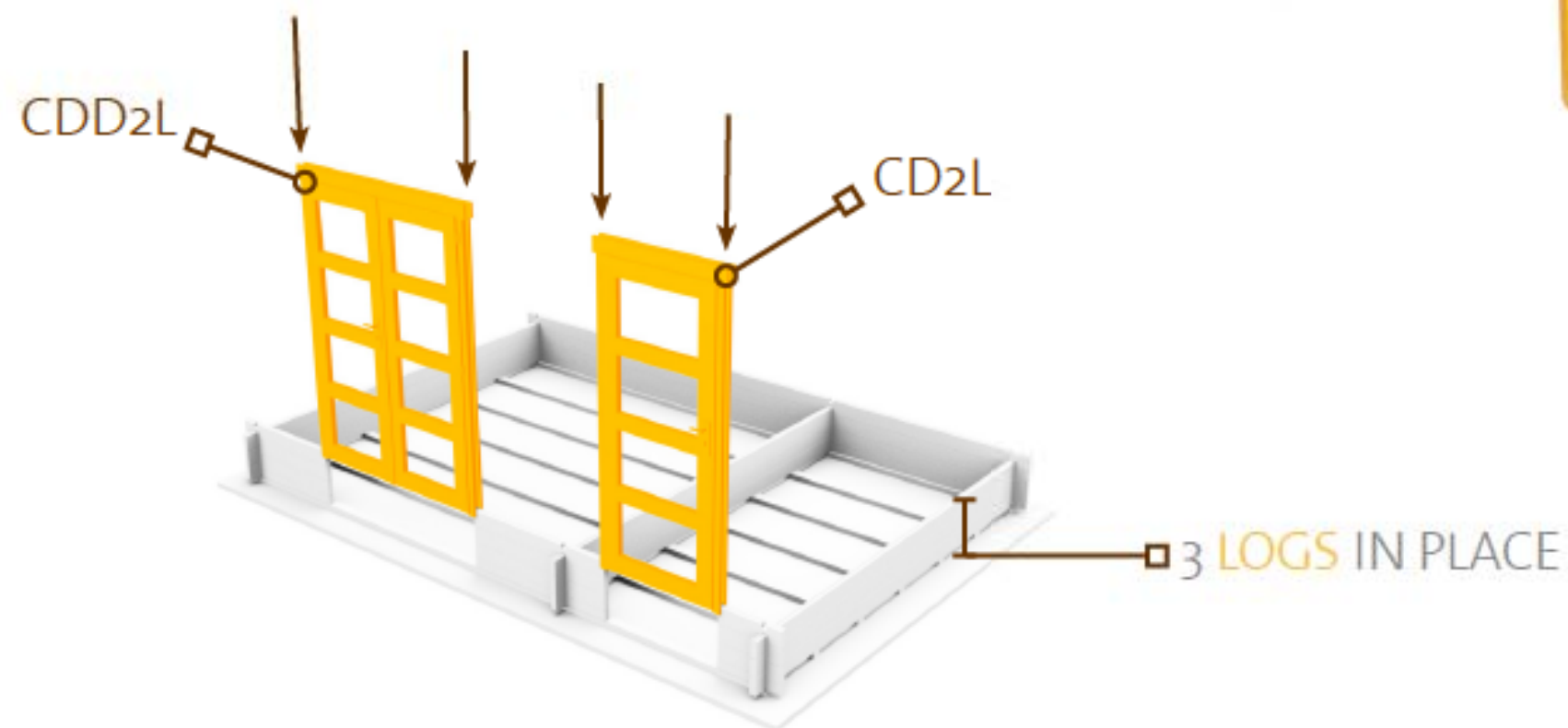

DON`T FORGET TO
TIGHTEN THE LOGS AFTER
EVERY 3-4 ROWS.

FREDRIKSTAD 40

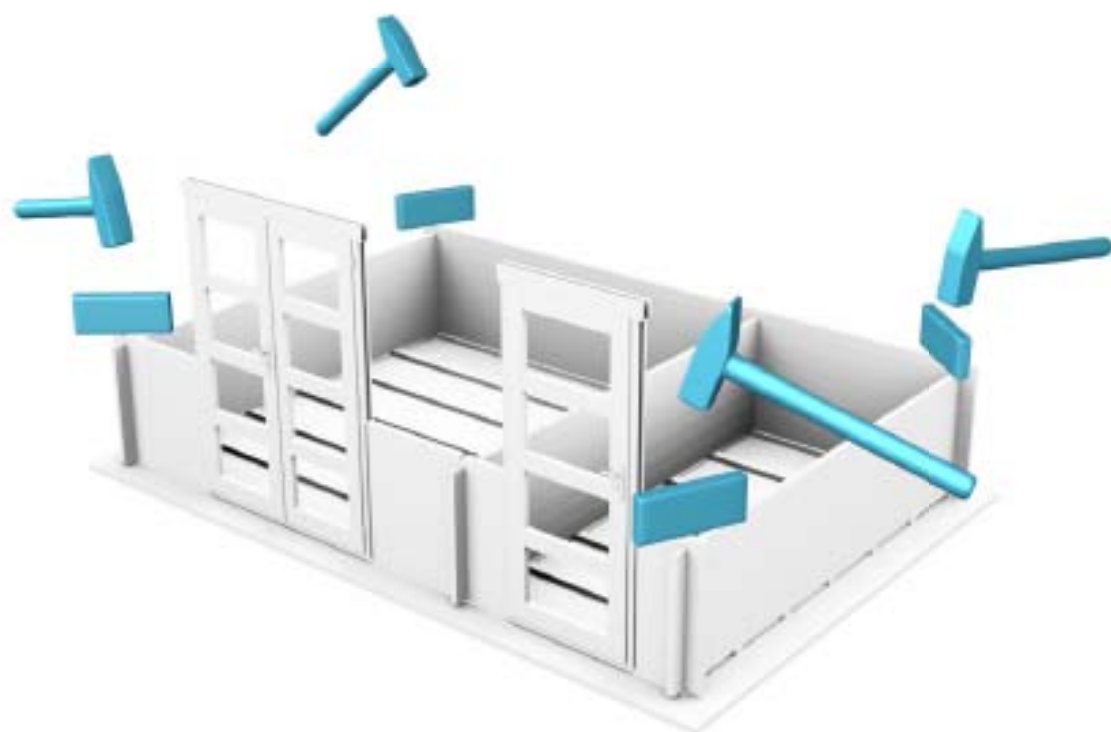

INSTALL THE **GABLES** WITH **LONG SCREWS** TO THE WALL LOGS ON THE FRONT AND REAR WALLS.

FREDRIKSTAD 40

6x140 x 9

Ø 5 mm

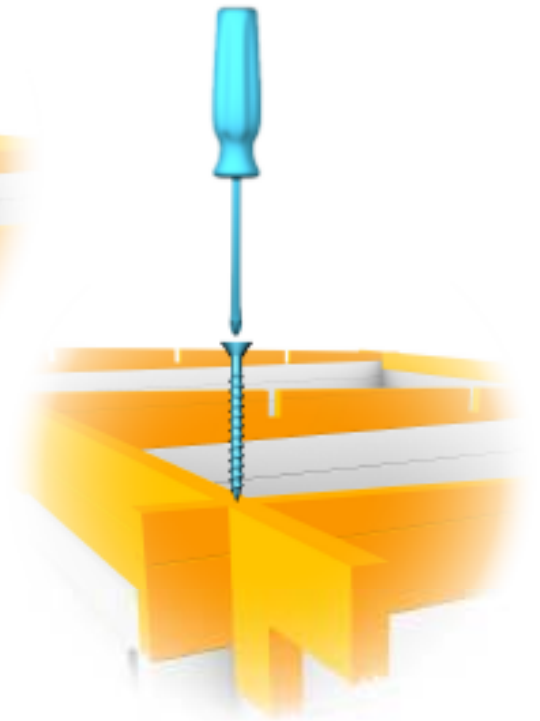
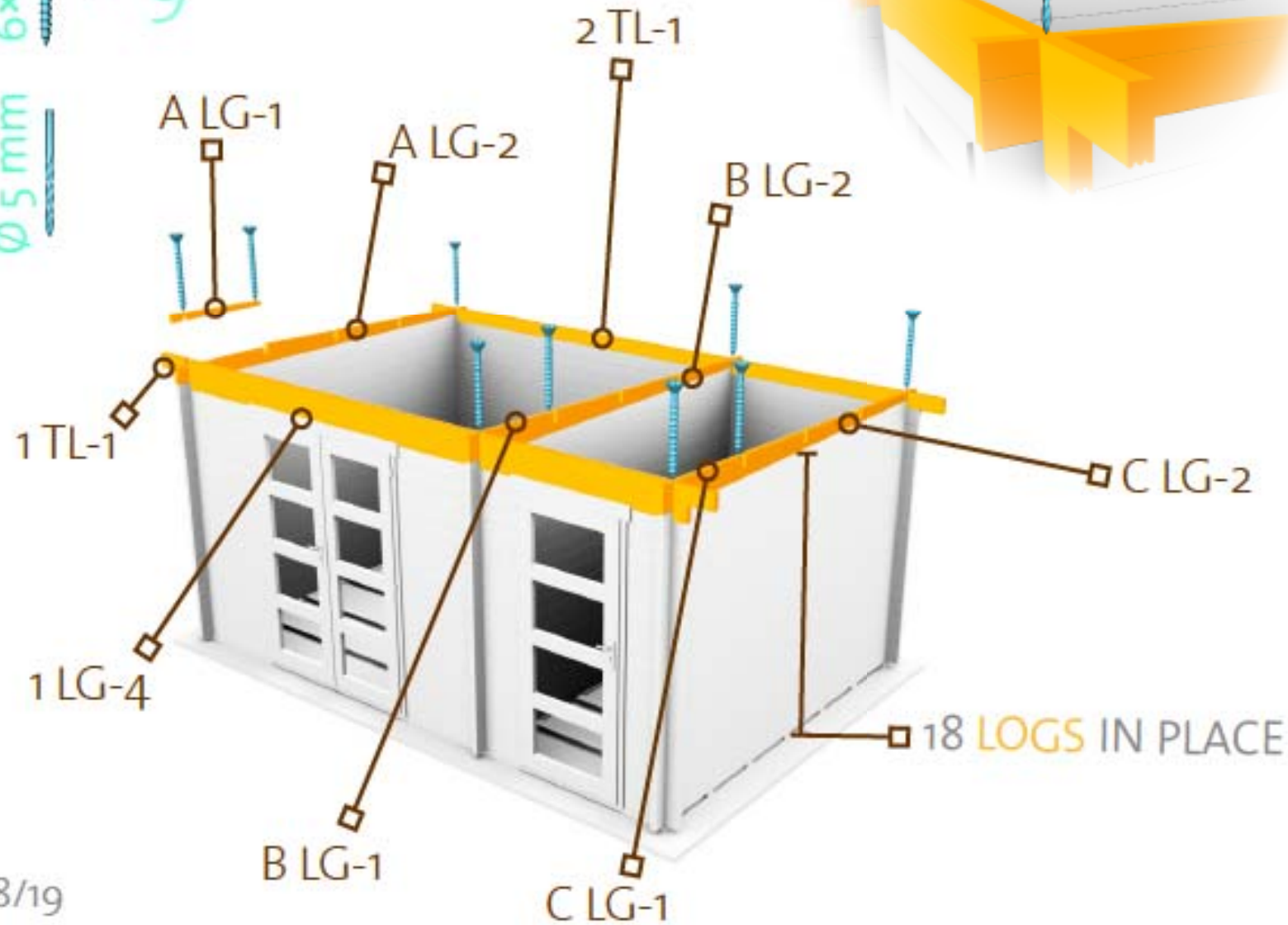

INSTALL THE **ROOF** PURLINS AND ROOF ELEMENTS, **ATTACH** THEM WITH SCREWS.

6x140 × 29

Ø 4 mm

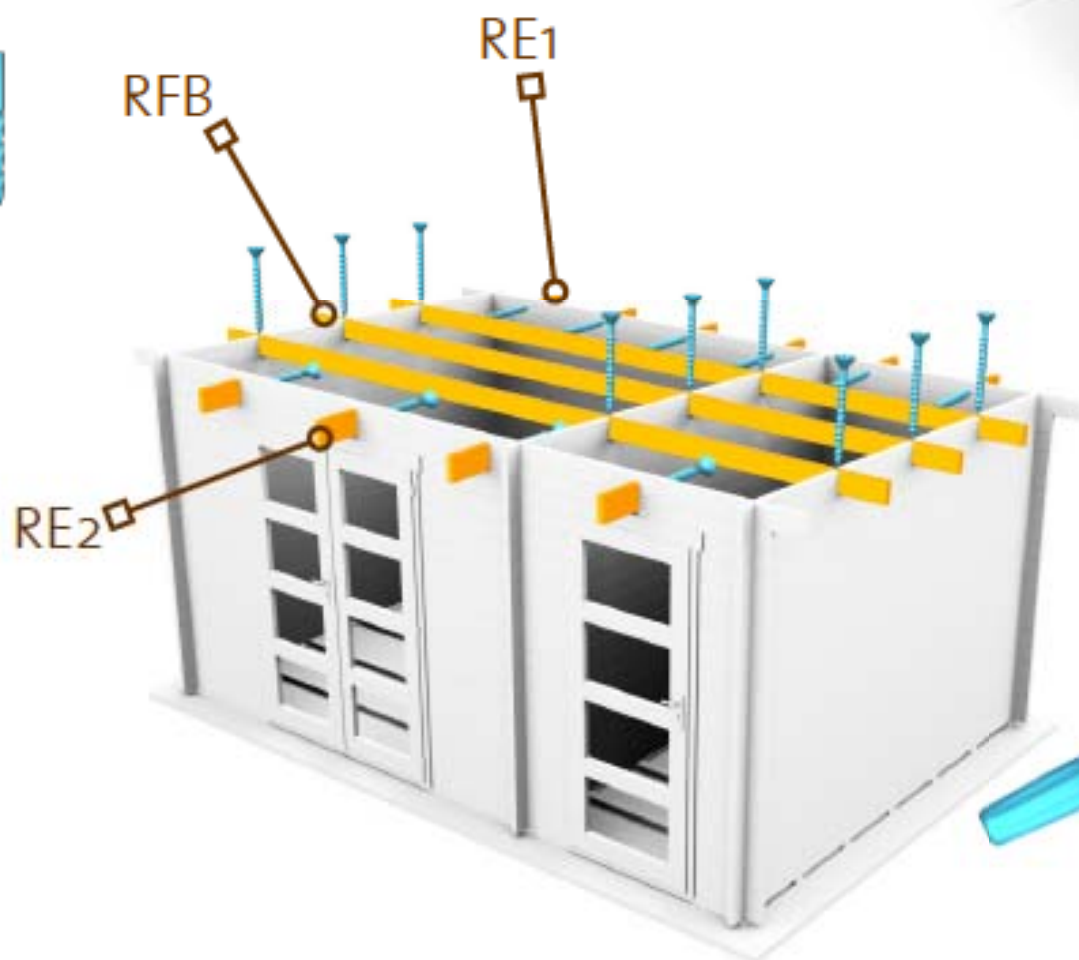

FREDRIKSTAD 40

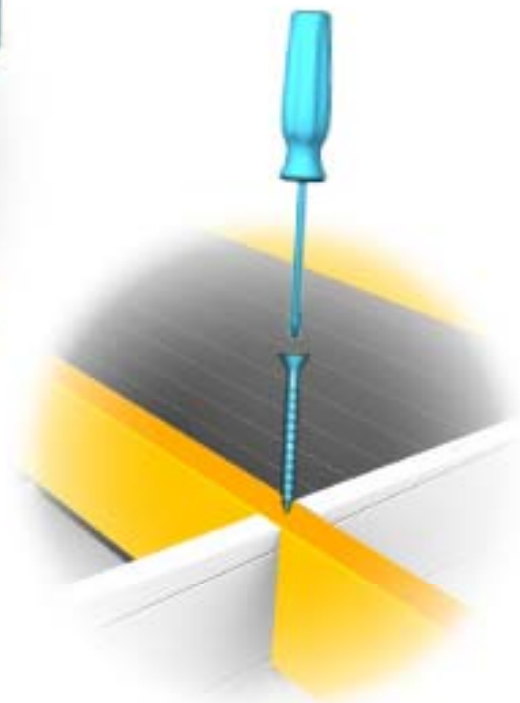

SCREW RS1 AND RS2 TO PURLINS AND ROOF ELEMENTS.

FREDRIKSTAD 40

6x140 x 36

Ø 5 mm



USE SCREWS TO CONNECT
ROOF SIDES.

FREDRIKSTAD 40

4x50
x 12
Ø 4 mm

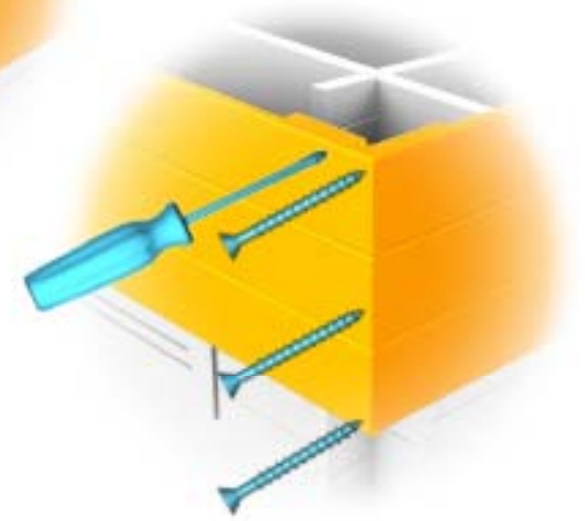

SAW ROOFBOARDS SO THAT IT IS POSSIBLE TO ATTACH THEM AGAINST ROOF SIDES.

FREDRIKSTAD 40

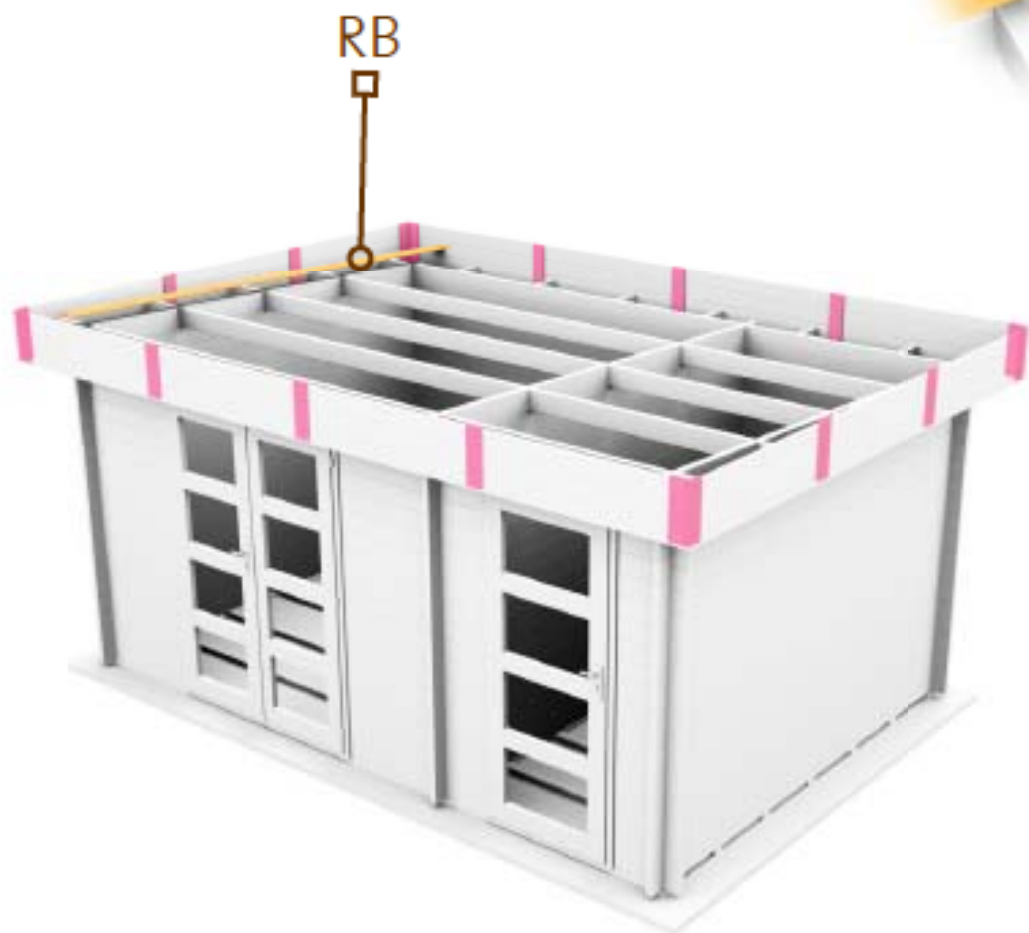

AT THE BACK OF THE HOUSE WILL BE A GAP BETWEEN THE ROOFSIDE AND THE ROOFBOARD 79%

PLACE THE FIRST **ROOFBOARD** FLUSH WITH THE **END** OF THE PURLINS AND ATTACH WITH 10 SCREWS, 5 **INTO** EACH NEXT.

FREDRIKSTAD 40

4x50
x 240

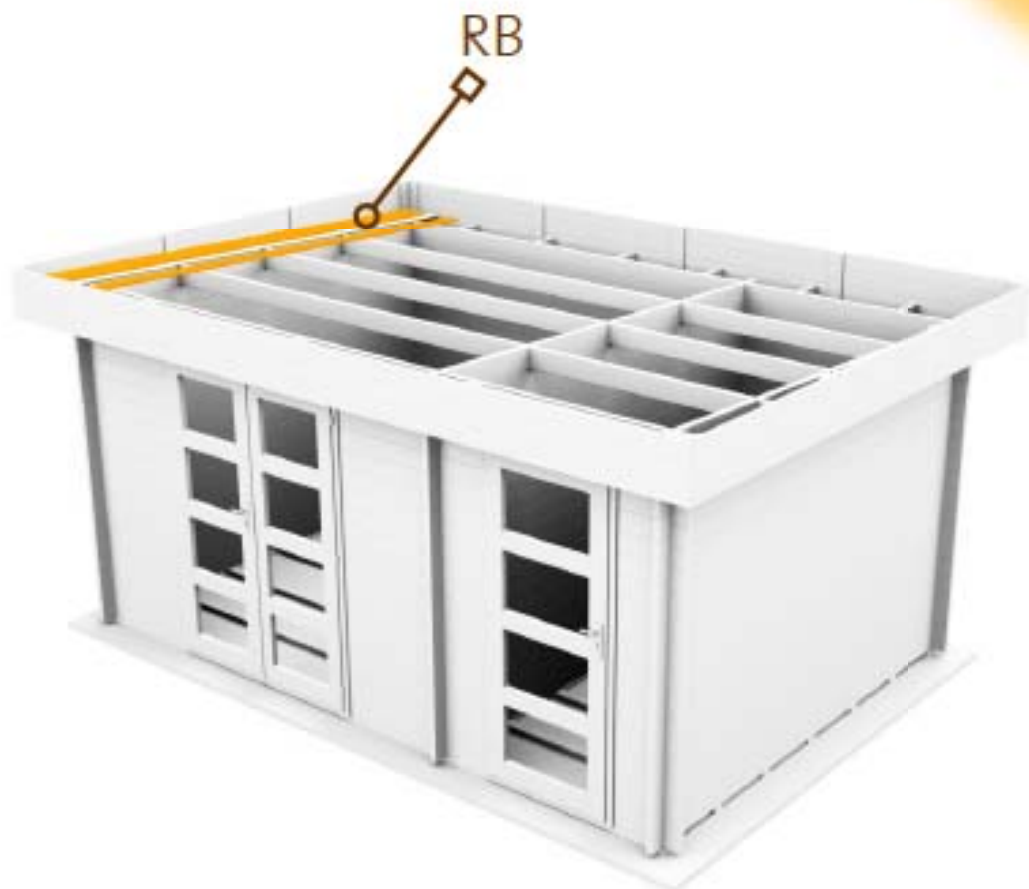
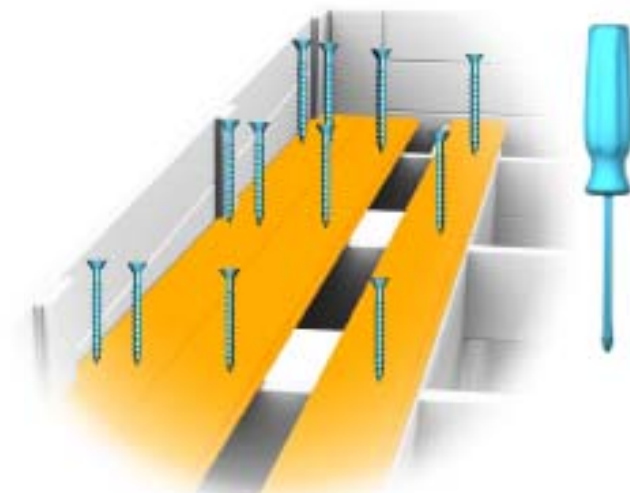

10 SCREWS INTO THE FIRST FLOORBOARD,
5 INTO EACH NEXT, SAW THE
LAST BOARD TO MAKE IT FIT.

4x50
x 301

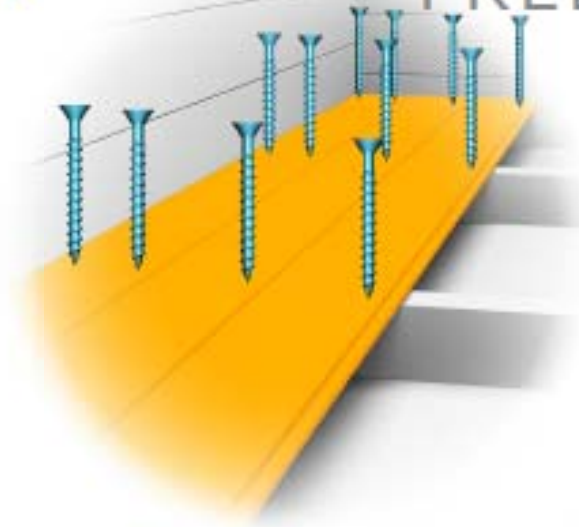

FREDRIKSTAD 40

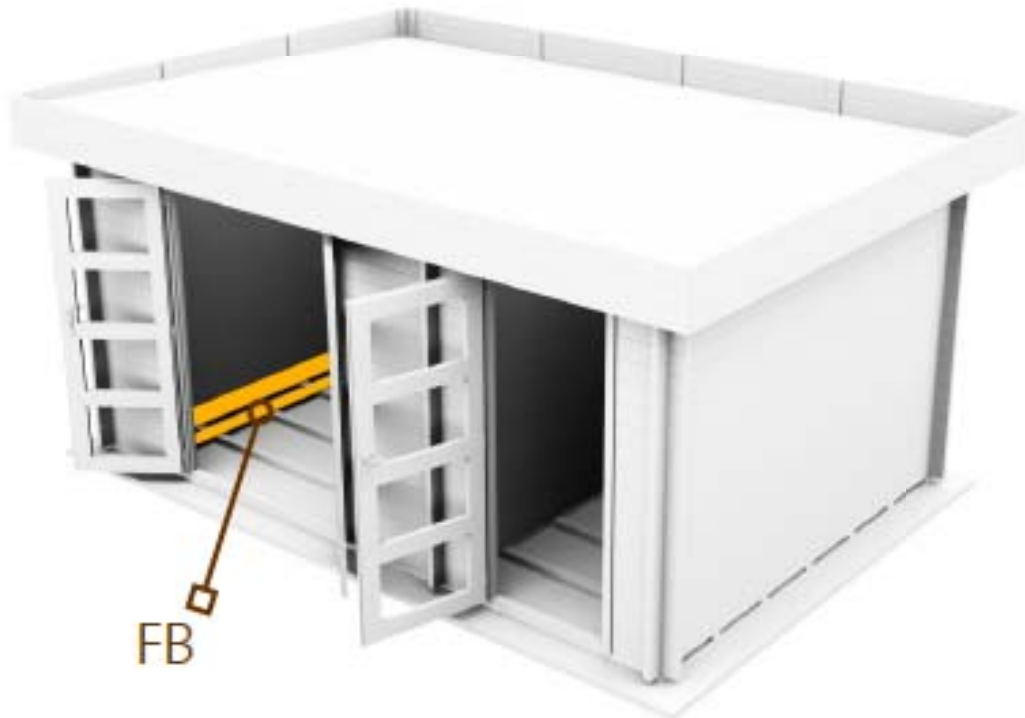
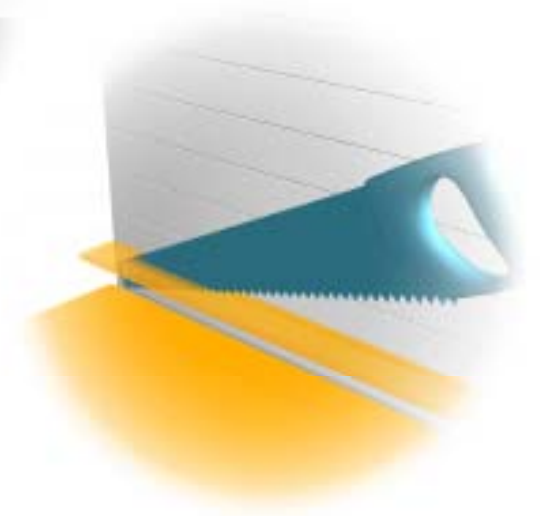

FB

SAW THE **BASEBOARDS**
AND ATTACH WITH NAILS
AT **EVERY 0,5** METERS

1,4x40
× 45

FREDRIKSTAD 40

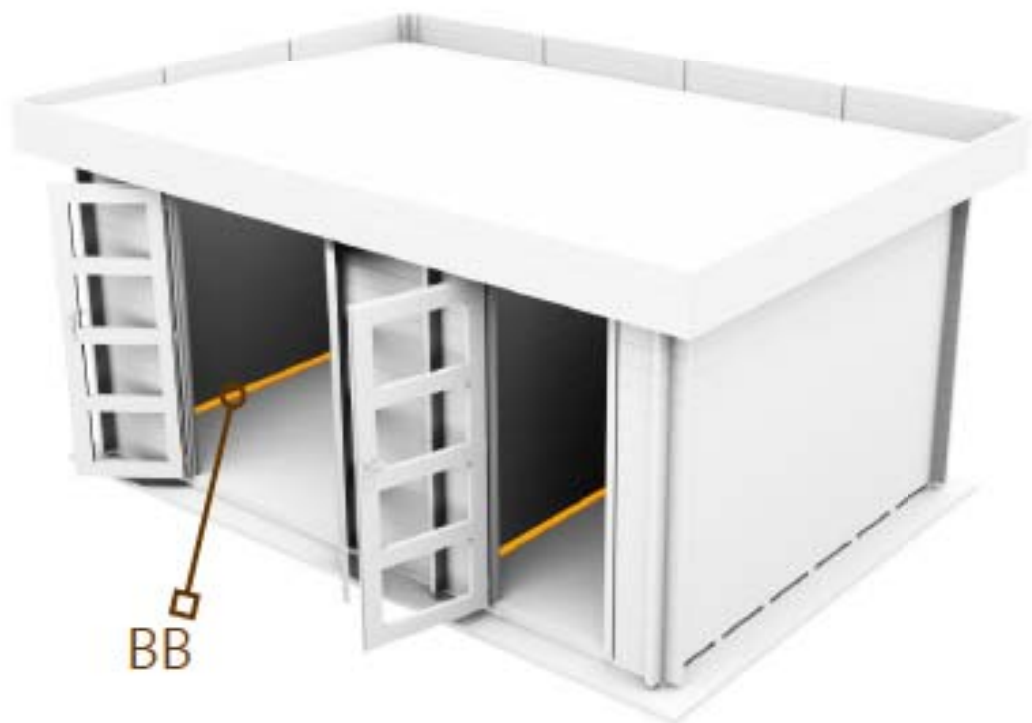
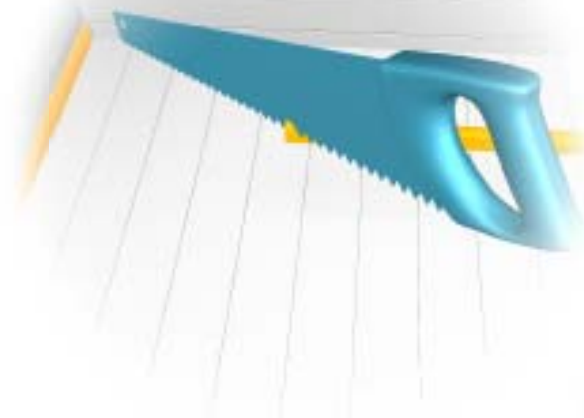

DRILL THROUGH THE WALL, HOLE MUST BE AT THE BOTTOM OF THE OVAL, ATTACH WITH BOLT.

M8x70 × 12

Ø 8 mm



WINDBOARD

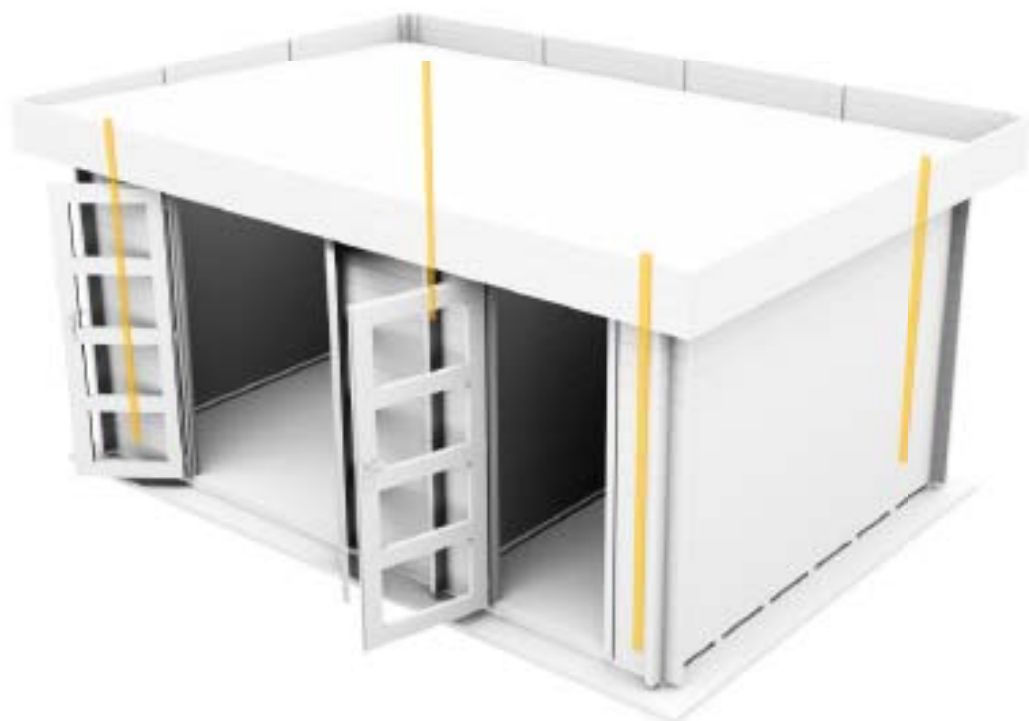

IF DOOR IS TILTED,
PUSH THE DOOR FRAME SO
THAT ALL CORNERS ARE 90° .

FREDRIKSTAD 40

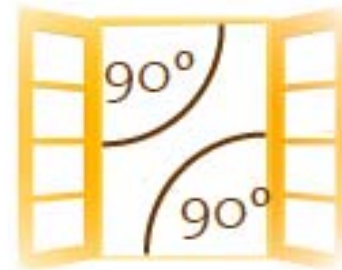
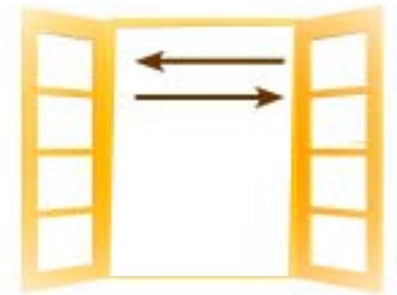

IF **DOORS** ARE IN DIFFERENT HEIGHTS OR THERE IS A GAP **BETWEEN** THEM, **ADJUST** 3 SCREWS ON DOOR HINGES.

FREDRIKSTAD 40

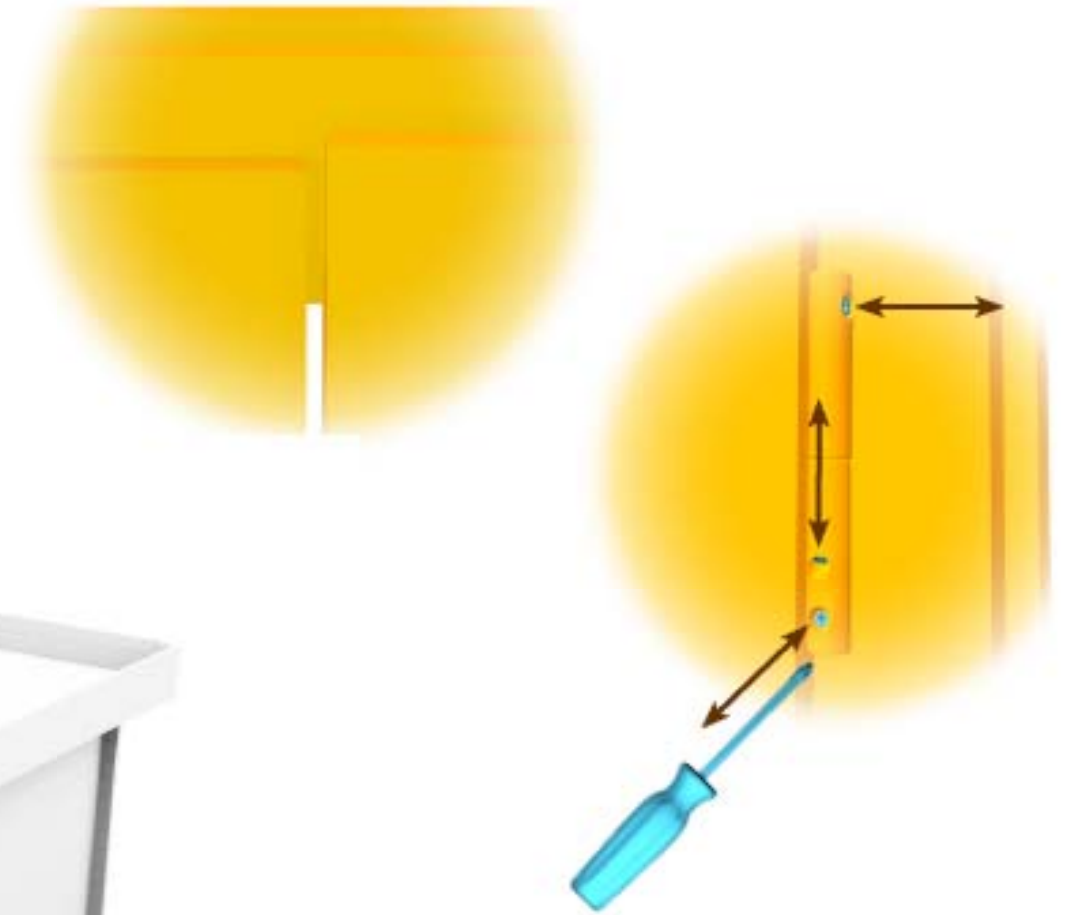

WHEN THE **HOUSE** IS ASSEMBLED, YOU SHOULD **COVER** THE TIMBER WITH **WOOD** PROTECTIVE SEAL, PAINT OR **STAIN** AS SOON AS POSSIBLE TO AVOID DETERIORATION TO THE **WOOD**.

FREDRIKSTAD 40

