

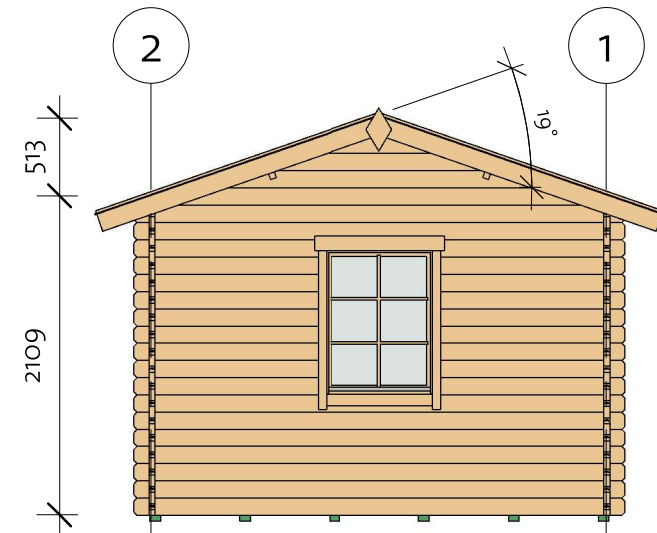

Karmen 40 (485x305)

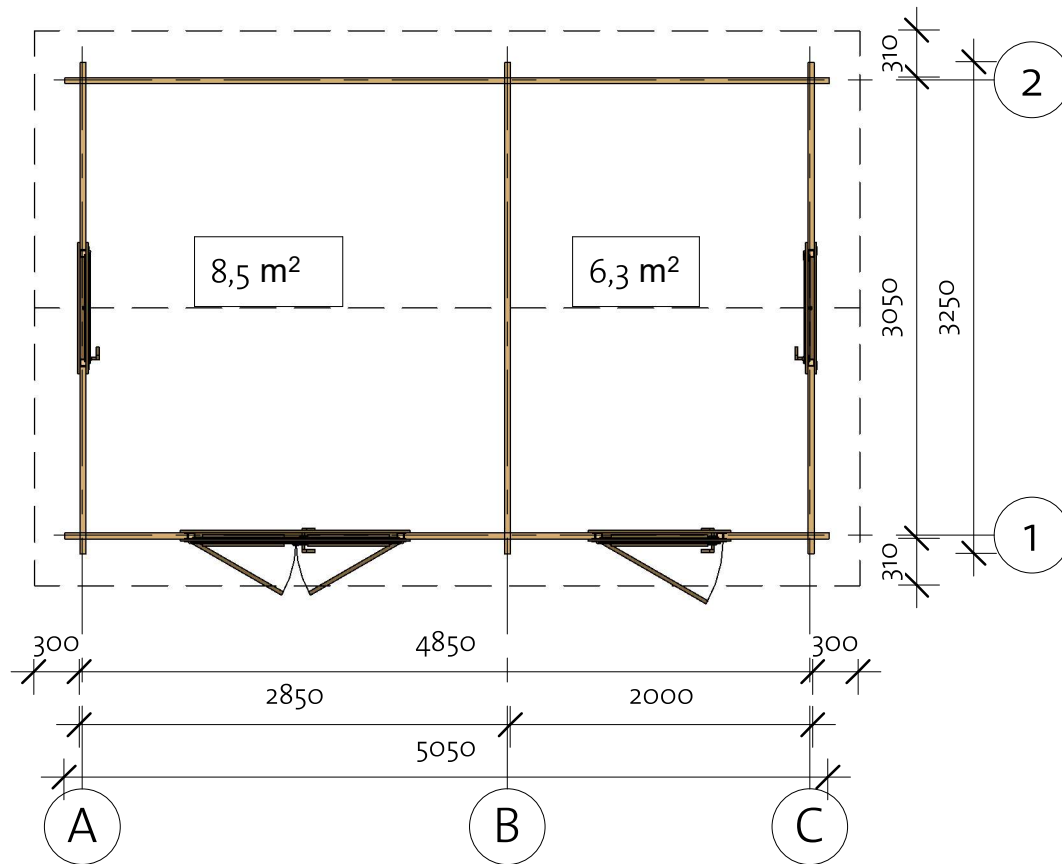
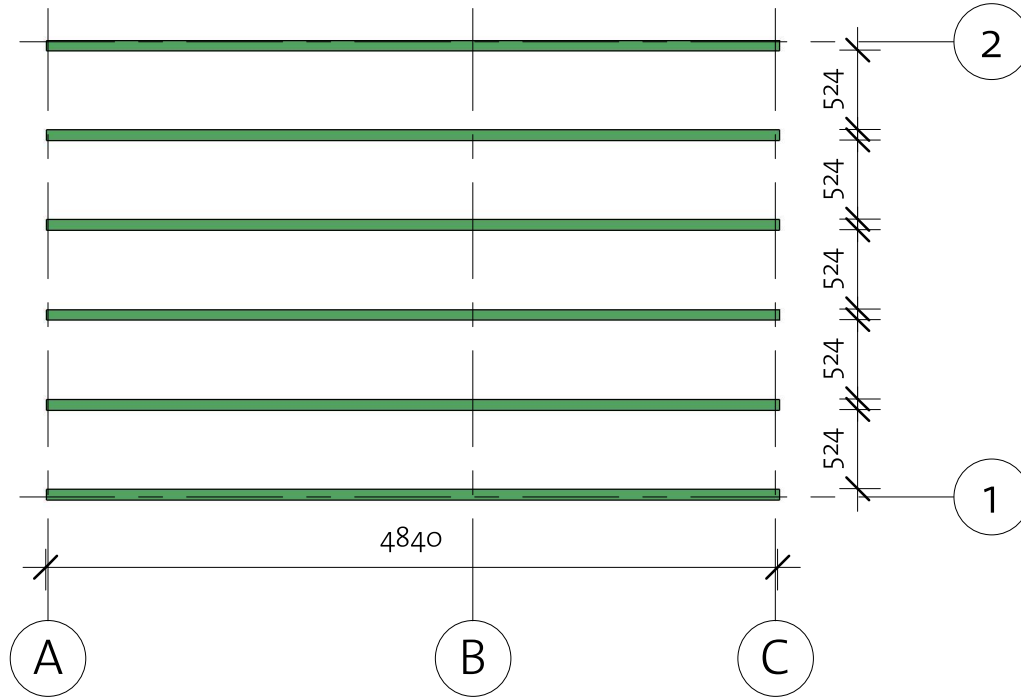

Karmen 40 (485x305)

Foundation



Impregnated foundation beams				
Mark	Type	Profile	Count	Length
IFB	IFB 70x40		6	4840



Karmen 40 (485x305)

Floor Plan

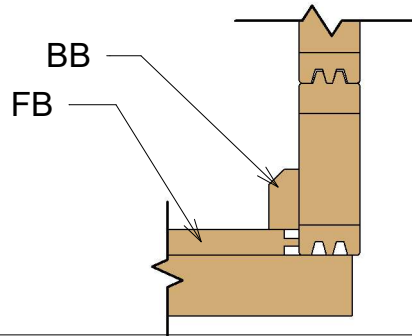
1 Baseboard



Floor Schedule

Mark	Type	Profile	Count	Length
FB	FB 17x114		43	2964
BB1	BB 20x40		2	4800
BB2	BB 20x40		4	3050

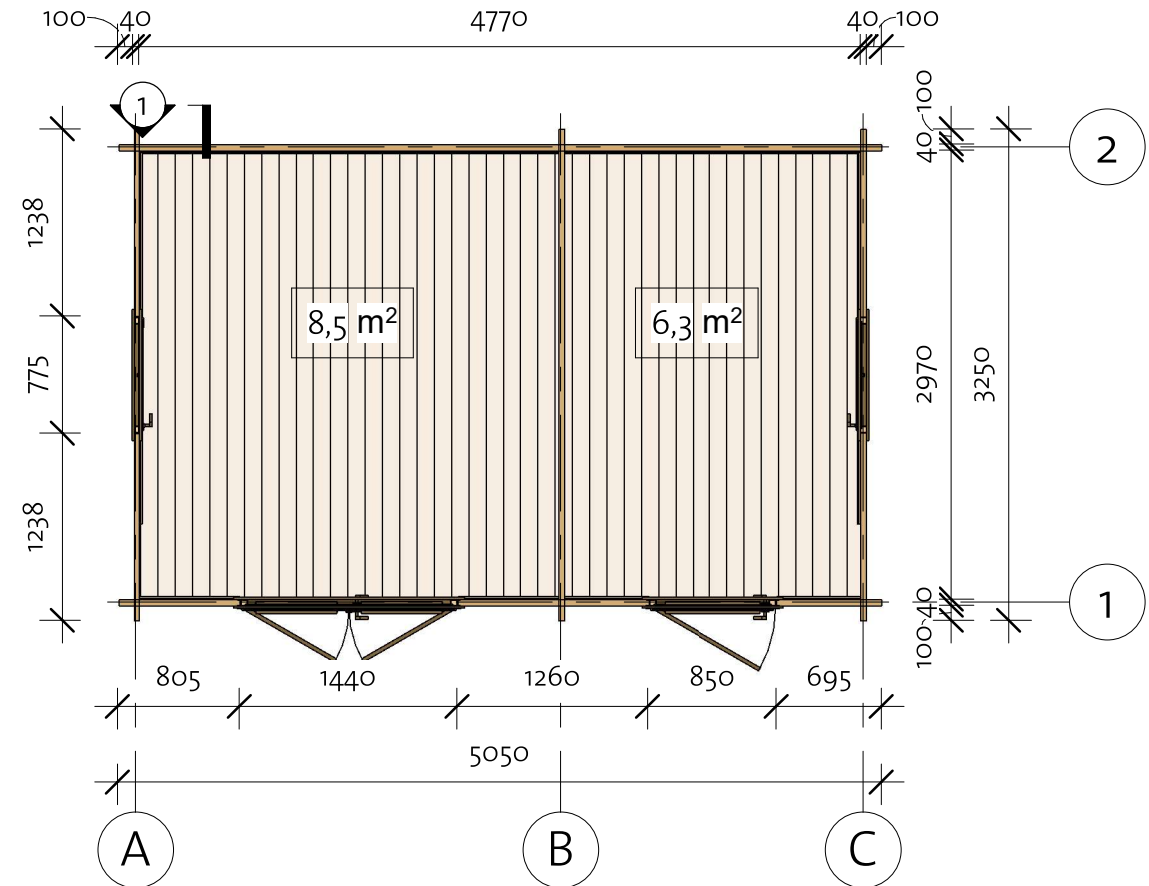

Karmen 40 (485x305)

Wall 1

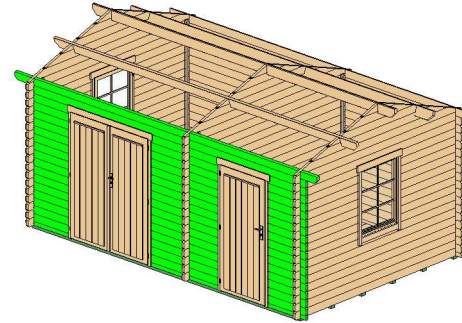

Wall 1			
Mark	Profile	Count	Cut Length

1BL-1	40x57	1	695
1BL-2	40x57	1	805
1BL-3	40x57	1	1260
1LG-1	40x114	16	695
1LG-2	40x114	16	805
1LG-3	40x114	16	1260
1LG-4	40x114	1	5050
1TL-1	40x114	1	5450

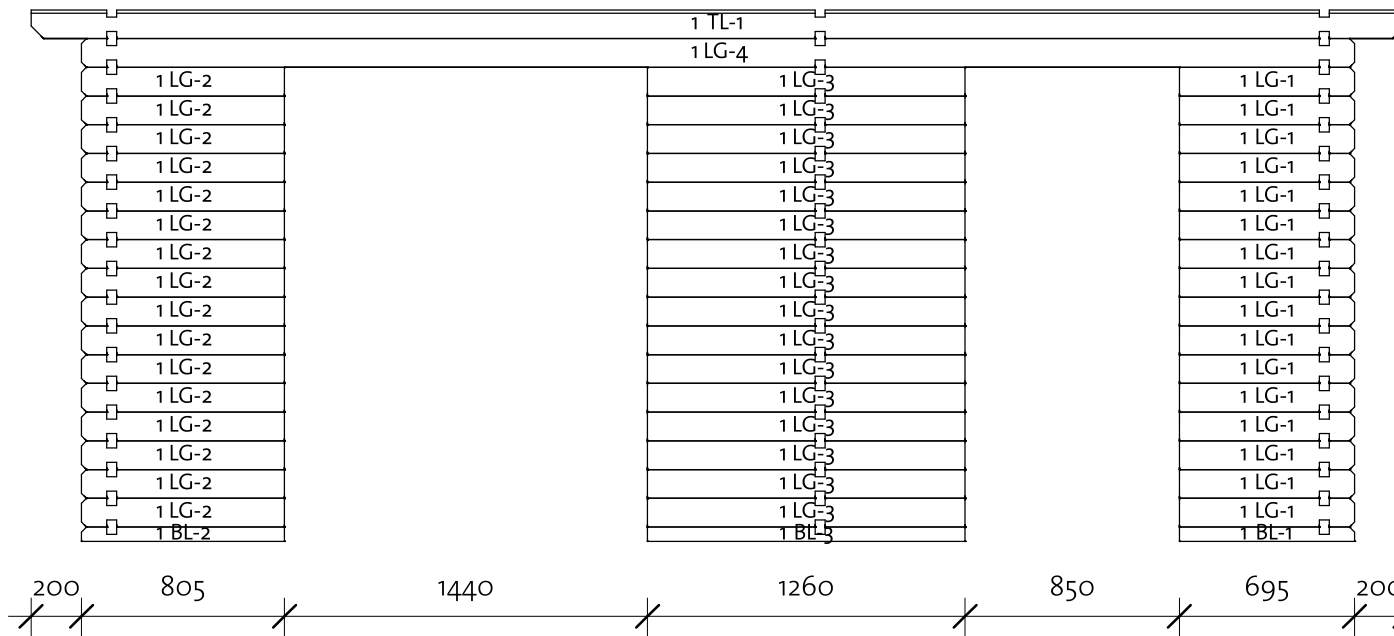

Log Profile Wall 1	
Profile	Profile

40x57	
40x114	
40x114	

Karmen 40 (485x305)

Wall 2

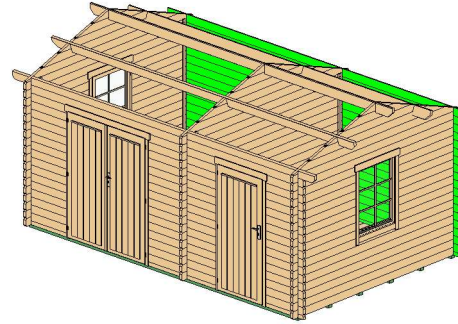

Wall 2			
Mark	Profile	Count	Cut Length
2BL-1	40X57	1	5050
2LG-1	40X114	17	5050
2TL-1	40X114	1	5450

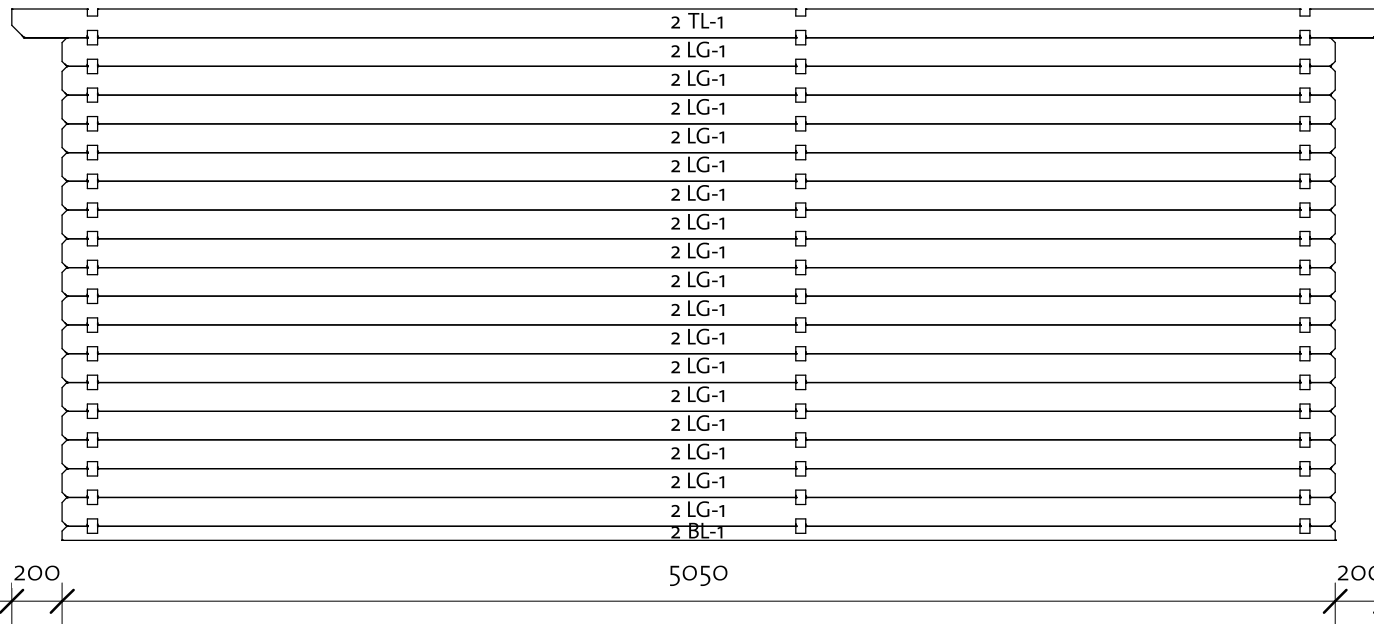

Log Profile Wall 2	
Profile	Profile
40X57	
40X114	
40X114	

Karmen 40 (485x305)

Wall A

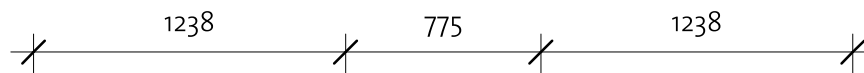
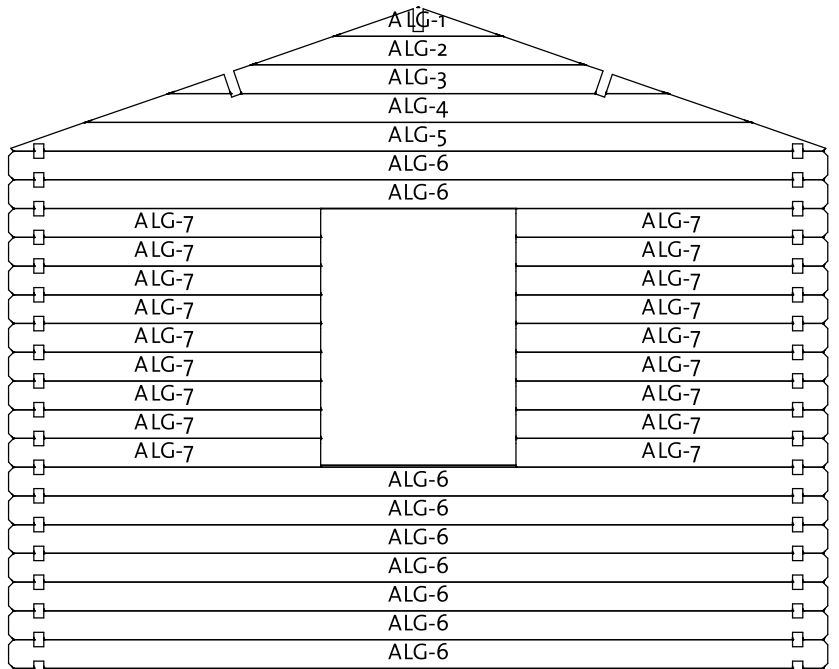
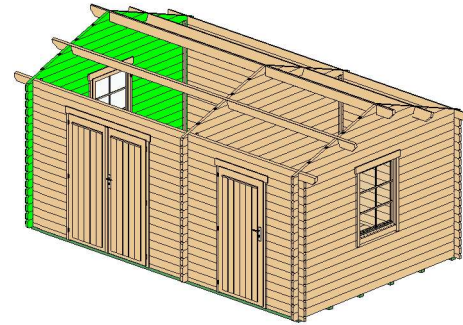

Wall A			
Mark	Profile	Count	Cut Length

ALG-1*	40X114	1	668
ALG-2*	40X114	1	1326
ALG-3*	40X114	1	1983
ALG-4*	40X114	1	2641
ALG-5*	40X114	1	3233
ALG-6	40X114	9	3250
ALG-7	40X114	18	1238

* Gable delivered premounted

Log Profile Wall A	
Profile	Profile

40X114	
--------	--

Karmen 40 (485x305)

Wall B

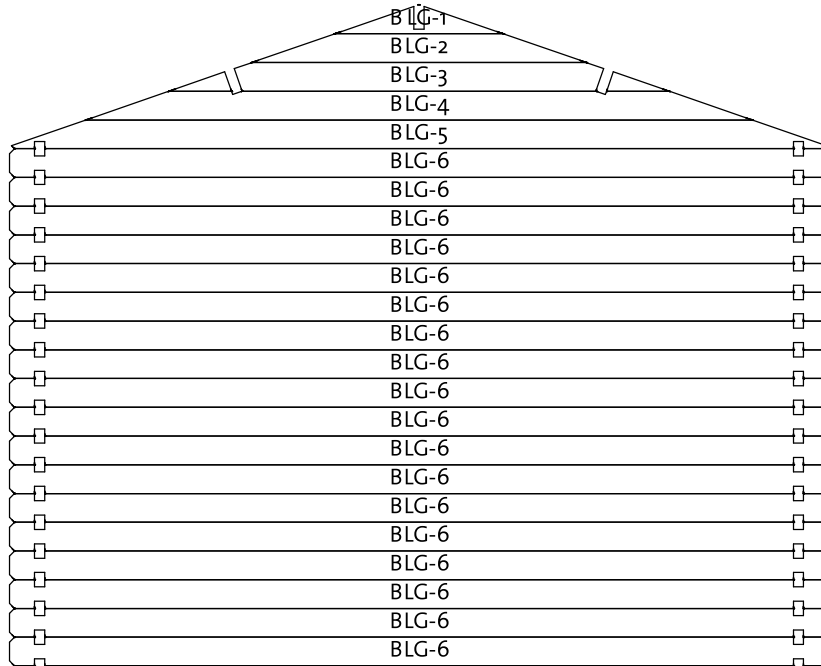
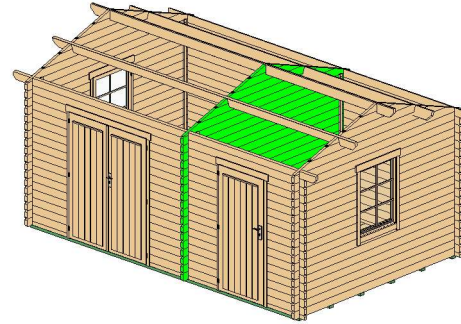

Wall B			
Mark	Profile	Count	Cut Length

BLG-1*	40X114	1	668
BLG-2*	40X114	1	1326
BLG-3*	40X114	1	1983
BLG-4*	40X114	1	2641
BLG-5*	40X114	1	3233
BLG-6	40X114	18	3250

* Gable delivered premounted

Log Profile Wall B	
Profile	Profile

40X114	
--------	---

Karmen 40 (485x305)

Wall C

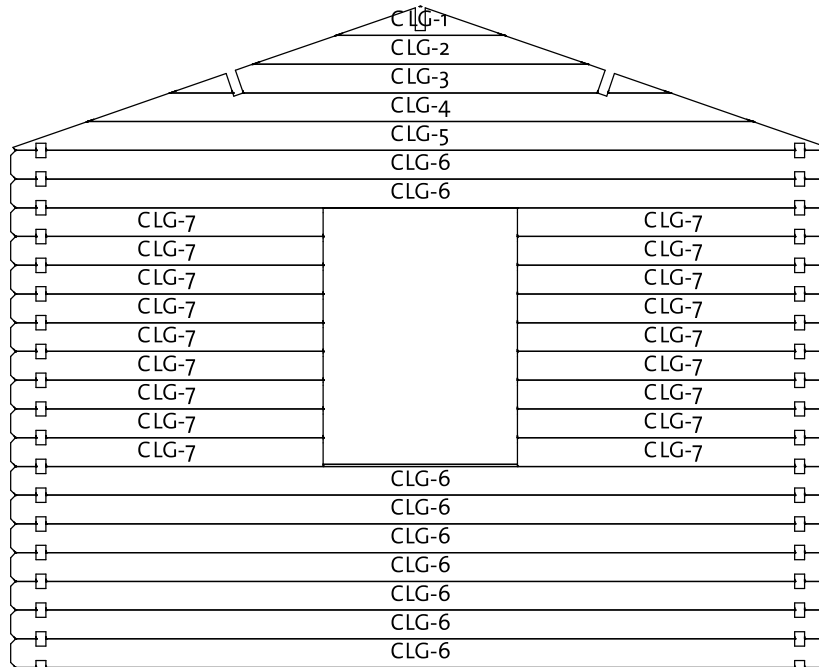
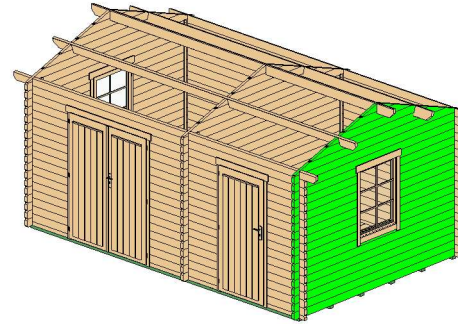

Wall C			
Mark	Profile	Count	Cut Length

CLG-1*	40x114	1	668
CLG-2*	40x114	1	1326
CLG-3*	40x114	1	1983
CLG-4*	40x114	1	2641
CLG-5*	40x114	1	3233
CLG-6	40x114	9	3250
CLG-7	40x114	18	1240

* Gable delivered premounted



Log Profile Wall C	
Profile	Profile

40x114	
--------	--

Karmen 40 (485x305)

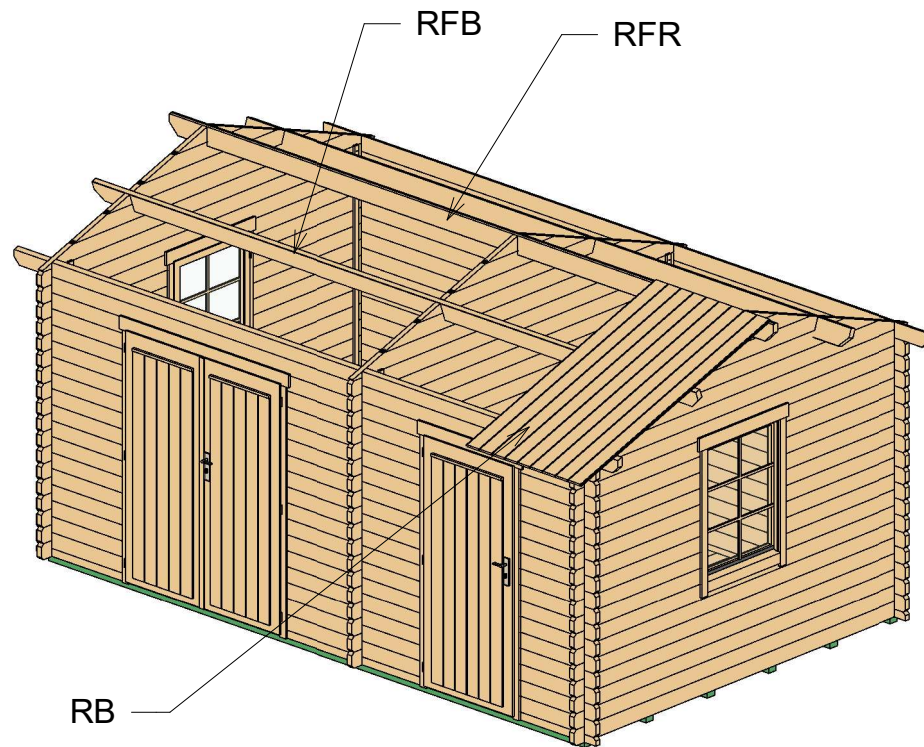
Roof 1



Roof				
Mark	Type	Profile	Count	Length
RFR	Ridge 40x143		1	5450
RFB	Beam 40x143		2	5450
RB	17x114		98	1936

Karmen 40 (485x305)

Roof 2

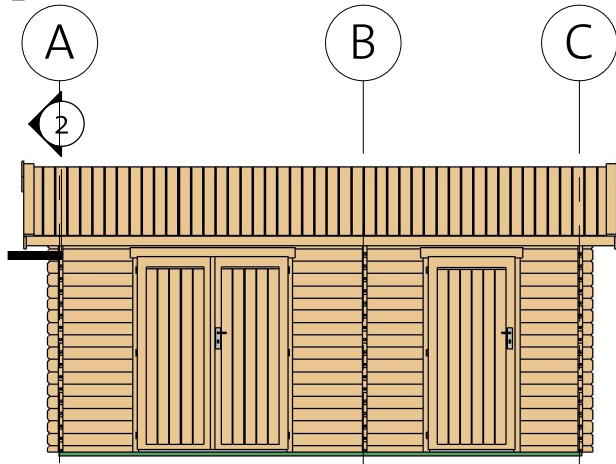

② Roof reinforcement

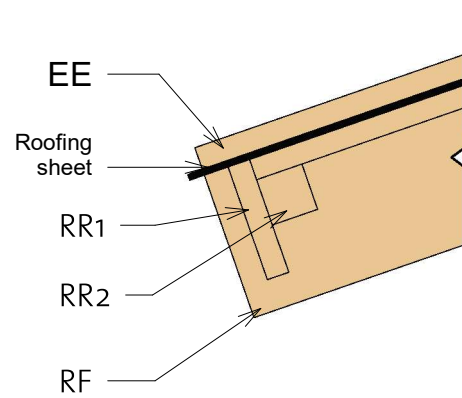

③ Fascia

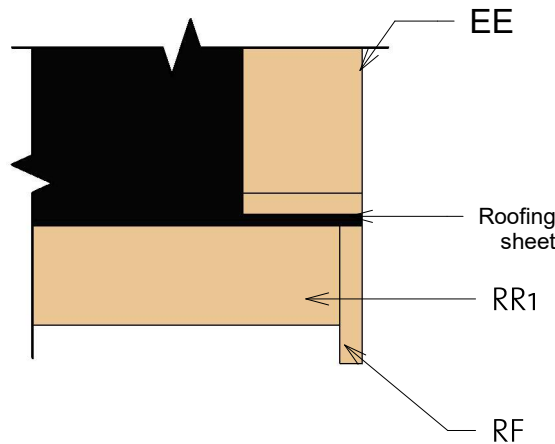
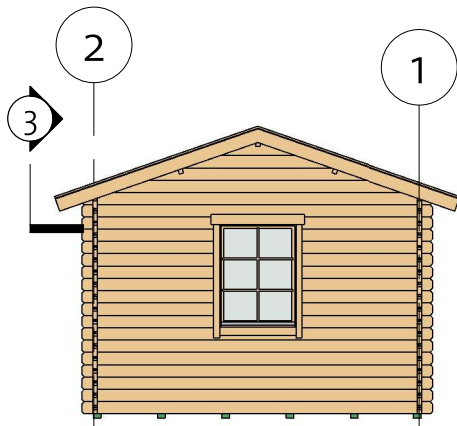

Fascia Schedule

Mark	Type	Profile	Count	Length
EE	Eave Edging 18x95		4	1980
RF	Roof Fascia 18x120		4	1980
RR1	Roof reinforcement 18x95		2	5450
RR2	Roof reinforcement 38x38		2	5450

Karmen 40 (485x305)

Extras

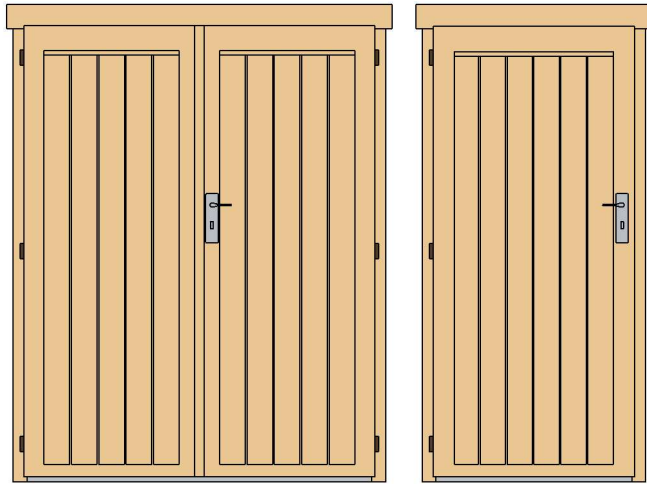





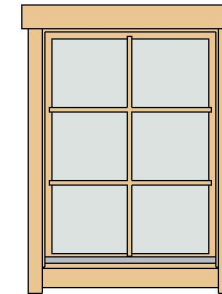

CDD26R	Classic double door 26, wood right	1425	1835	1
CD11L	Classic door 11, wood left	840	1835	1

CW1L	Classic window 1 left	765	990	1
CW1R	Classic window 1 right	765	990	1



WCB6	Windows Crossbar 6	--	--	2
------	--------------------	----	----	---

Hitblock	300-400 mm		
Screws	5,0 x 70		18
Bolts	M8x70		18
Screws	6,0 x 140		45
Nails	1,4 x 40		55
Screws	4,0 x 40		90
Screws	4,0 x 50		605

Romb	
Type	Count

Romb	2
------	---



Windboard		
Type	Count	Length

Windboard 18x40	6	2200
-----------------	---	------



200629

Karmen 40 (485x305)

List of all items 1

Impregnated foundation beams

Mark	Type	Profile	Count	Length
------	------	---------	-------	--------

IFB	IFB 70x40		6	4840
-----	--------------	---	---	------

Roof

Mark	Type	Profile	Count	Length
------	------	---------	-------	--------

RFR	Ridge 40x143		1	5450
-----	-----------------	---	---	------

RFB	Beam 40x143		2	5450
-----	----------------	---	---	------

RB	17x114		98	1936
----	--------	---	----	------

Floor Schedule

Mark	Type	Profile	Count	Length
------	------	---------	-------	--------

FB	FB 17x114		43	2964
----	-----------	---	----	------

BB1	BB 20x40		2	4800
-----	-------------	---	---	------

BB2	BB 20x40		4	3050
-----	-------------	--	---	------

Fascia Schedule

Mark	Type	Profile	Count	Length
------	------	---------	-------	--------

EE	Eave Edging 18x95		4	1980
----	-------------------------	---	---	------

RF	Roof Fascia 18x120		4	1980
----	--------------------------	---	---	------

RR1	Roof reinforce ment 18x95		2	5450
-----	------------------------------------	---	---	------

RR2	Roof reinforce ment 38x38		2	5450
-----	------------------------------------	---	---	------

Karmen 40 (485x305)

List of all items 2

Wall 1			
Mark	Profile	Count	Cut Length

1BL-1	40x57	1	695
1BL-2	40x57	1	805
1BL-3	40x57	1	1260
1LG-1	40x114	16	695
1LG-2	40x114	16	805
1LG-3	40x114	16	1260
1LG-4	40x114	1	5050
1TL-1	40x114	1	5450

Wall A			
Mark	Profile	Count	Cut Length

ALG-1*	40x114	1	668
ALG-2*	40x114	1	1326
ALG-3*	40x114	1	1983
ALG-4*	40x114	1	2641
ALG-5*	40x114	1	3233
ALG-6	40x114	9	3250
ALG-7	40x114	18	1238

Wall B			
Mark	Profile	Count	Cut Length

BLG-1*	40x114	1	668
BLG-2*	40x114	1	1326
BLG-3*	40x114	1	1983
BLG-4*	40x114	1	2641
BLG-5*	40x114	1	3233
BLG-6	40x114	18	3250

Wall 2			
Mark	Profile	Count	Cut Length

2BL-1	40x57	1	5050
2LG-1	40x114	17	5050
2TL-1	40x114	1	5450

Wall C			
Mark	Profile	Count	Cut Length

CLG-1*	40x114	1	668
CLG-2*	40x114	1	1326
CLG-3*	40x114	1	1983
CLG-4*	40x114	1	2641
CLG-5*	40x114	1	3233
CLG-6	40x114	9	3250
CLG-7	40x114	18	1240

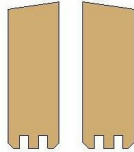
Log Profiles	
Profile	Profile
40x57	
40x114	
40x114	