

Osto Dresden 34

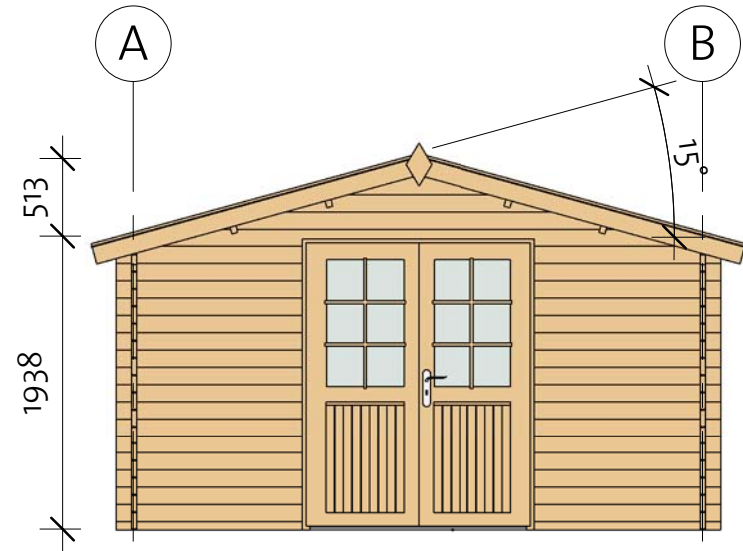

Osto Dresden 34

Floor Plan

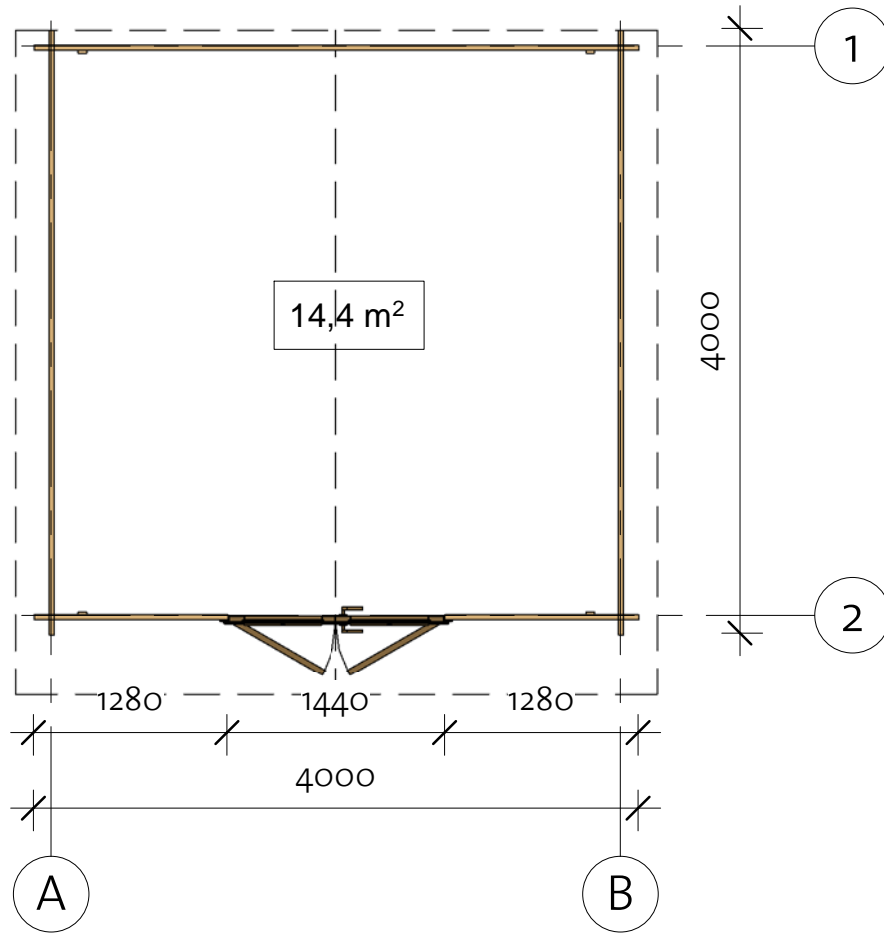
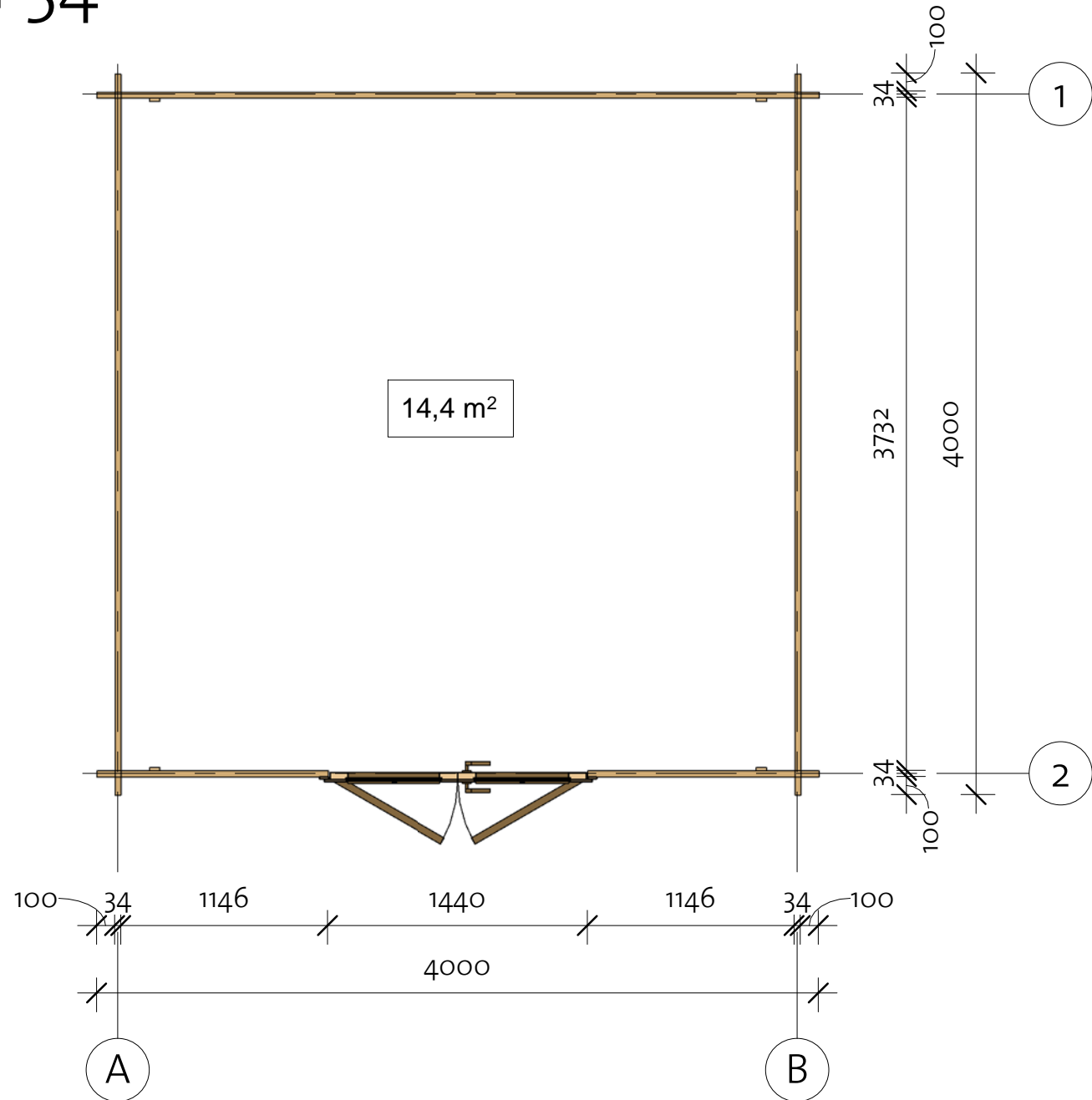

Osto Dresden 34

Wall 1

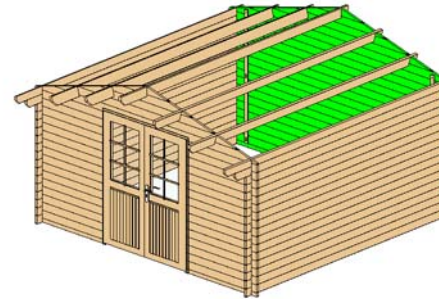

Wall 1			
Mark	Profile	Count	Cut Length

1BL-1	34X57	1	4000
1LG-1 *	34X114	1	831
1LG-2 *	34X114	1	1660
1LG-3 *	34X114	1	2471
1LG-4 *	34X114	1	3318
1LG-5	34X114	16	4000
1LG-6 *	34X114	1	4000

* Gable - delivered premounted

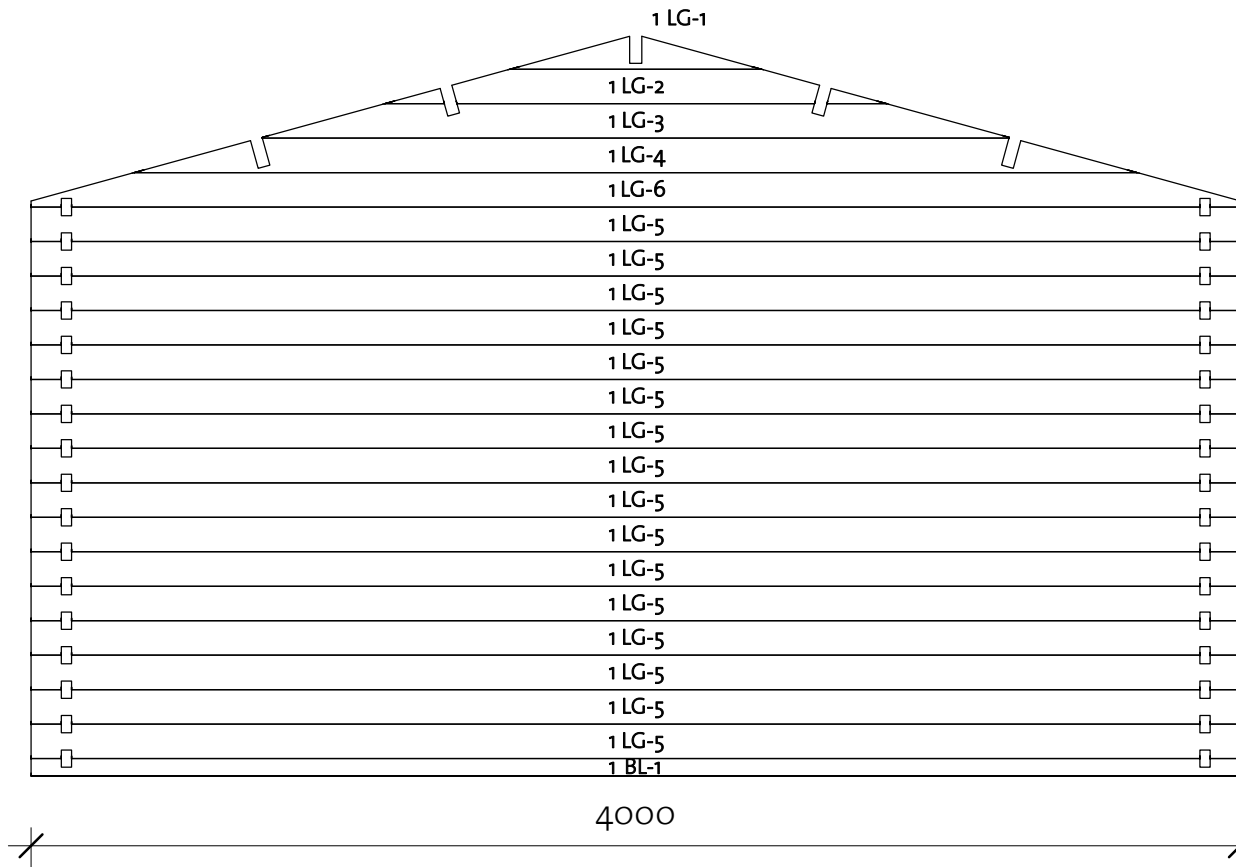

Log Profile Wall 1	
Profile	Profile

34X57	
34X114	

Osto Dresden 34

Wall 2



Wall 2

Mark	Profile	Count	Cut Length
------	---------	-------	------------

2BL-1	34x57	2	1280
2LG-1 *	34x114	1	831
2LG-2	34x114	32	1280
2LG-3 *	34x114	1	1660
2LG-4 *	34x114	1	2471
2LG-5 *	34x114	1	3318
2LG-6 *	34x114	1	4000

* Gable - delivered premounted

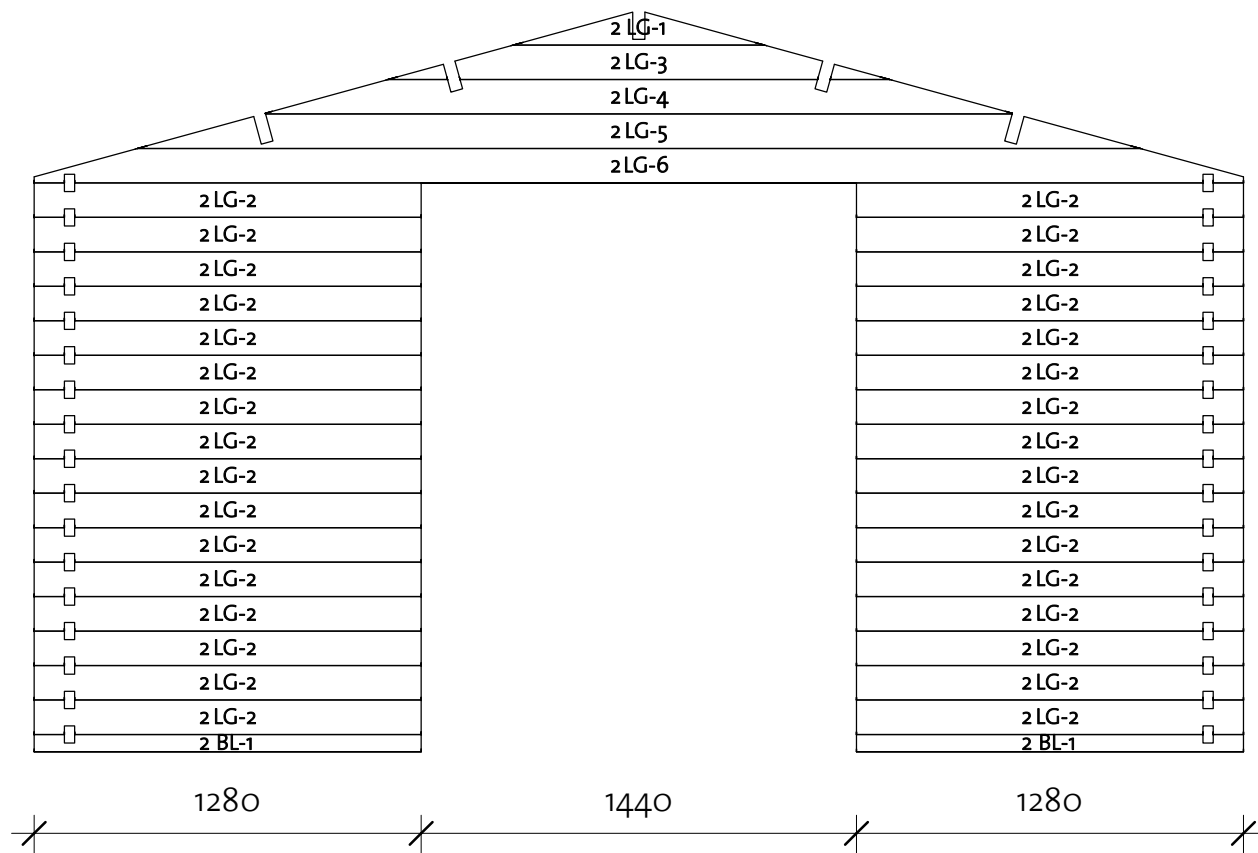

Log Profile Wall 2

Profile	Profile
---------	---------

34x57	
34x114	

Osto Dresden 34

Wall A

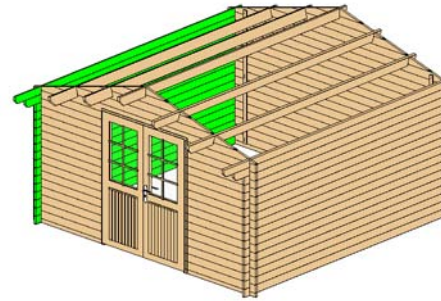

Wall A			
Mark	Profile	Count	Cut Length

ALG-1	34X114	15	4000
ALG-2	34X114	1	4200
ATL-1	34X114	1	4400

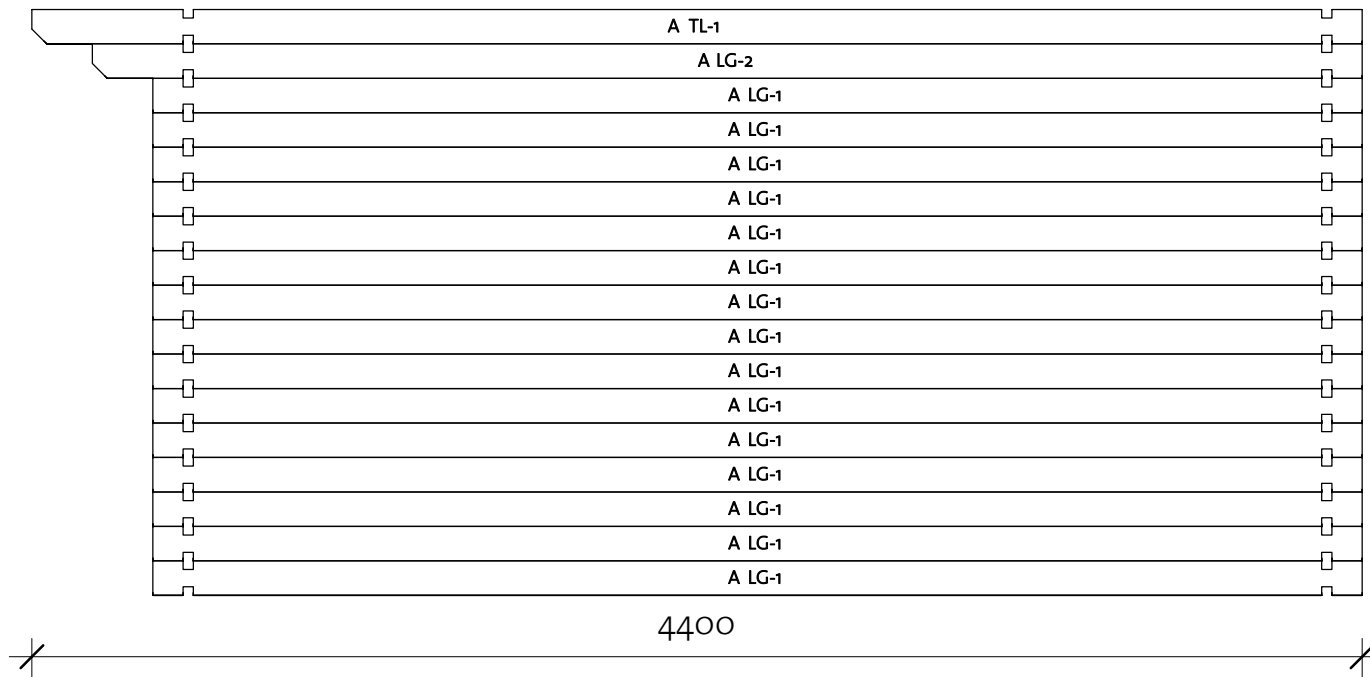

Log Profile Wall A	
Profile	Profile

34X114	
34X114	

Osto Dresden 34

Wall B

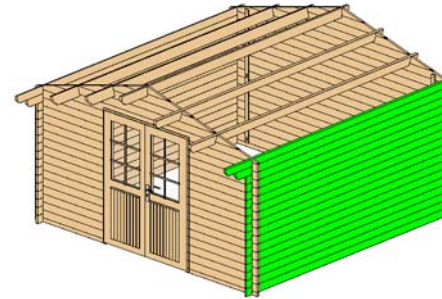

Wall B			
Mark	Profile	Count	Cut Length

BLG-1	34X114	15	4000
BLG-2	34X114	1	4200
BTL-1	34X114	1	4400

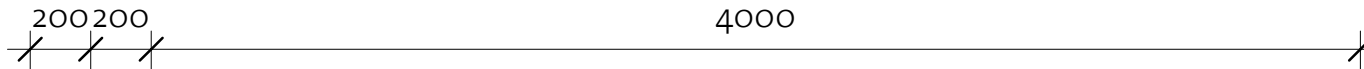
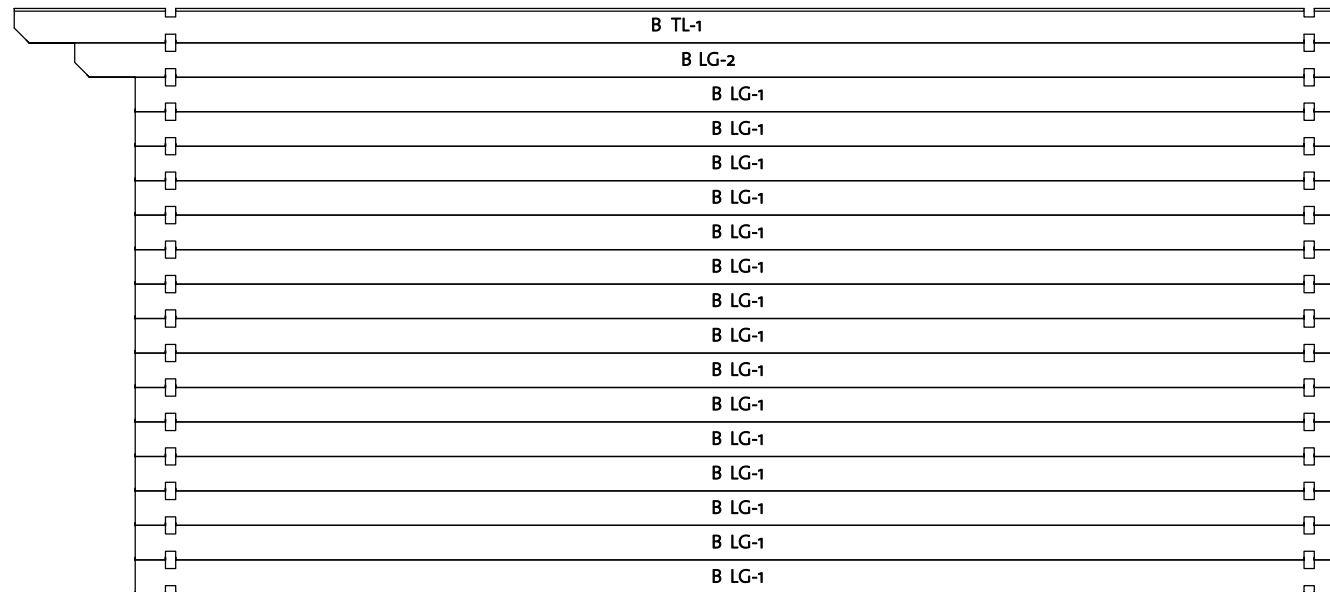





Log Profile Wall B	
Profile	Profile

34X114	
34X114	

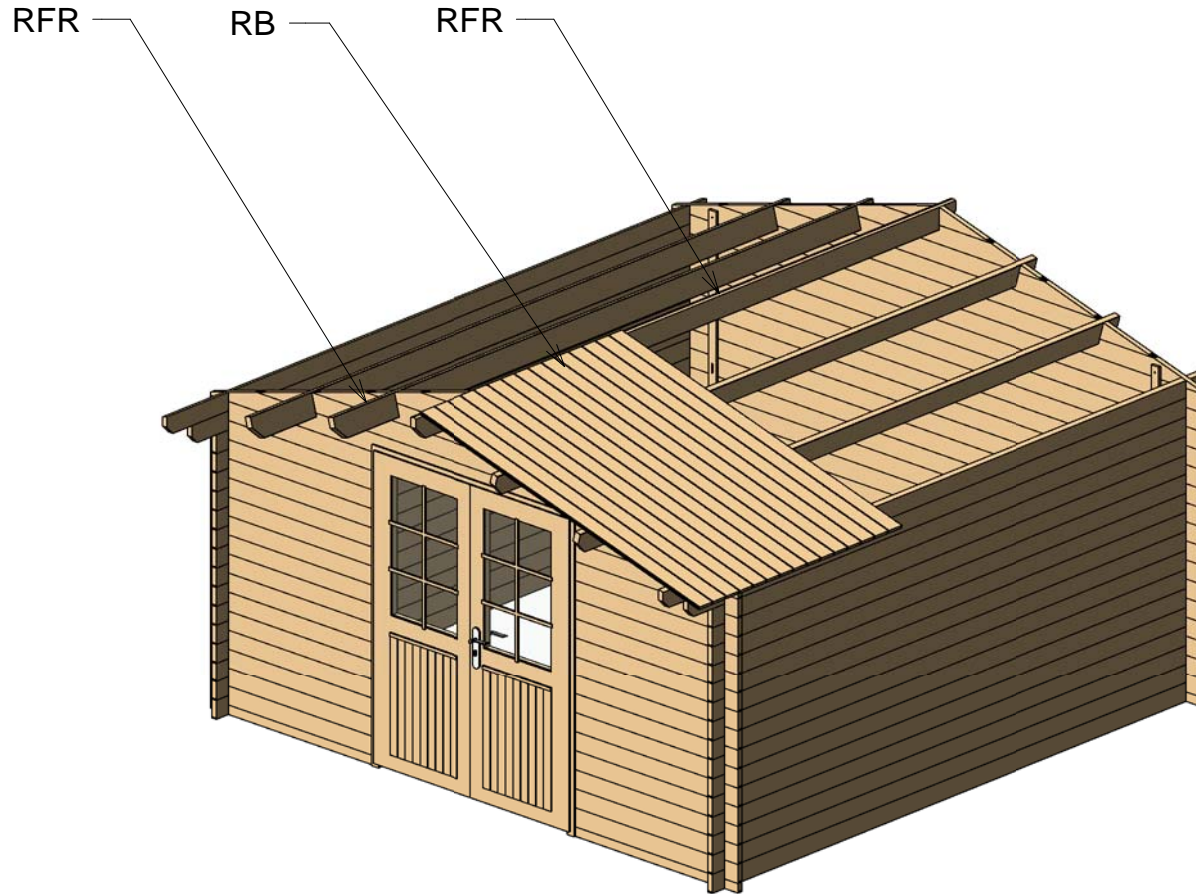
Osto Dresden 34

Roof 1



Roof				
Mark	Type	Profile	Count	Length
RFR	Ridge 40x143		1	4400
RFB	Beam 40x143		4	4400
RB	18x110		82	2197

Osto Dresden 34

Roof 2

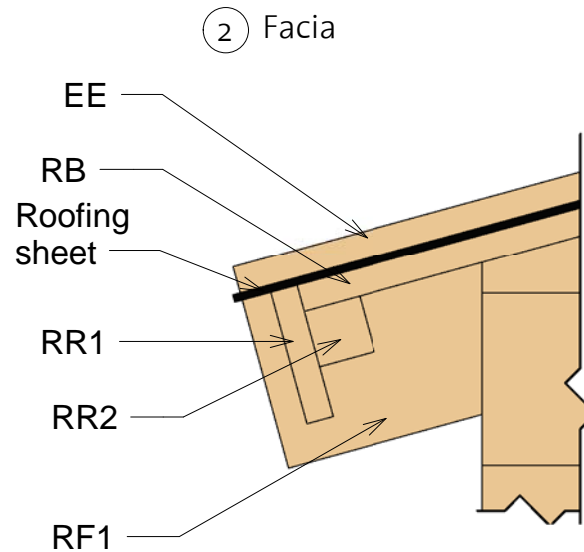
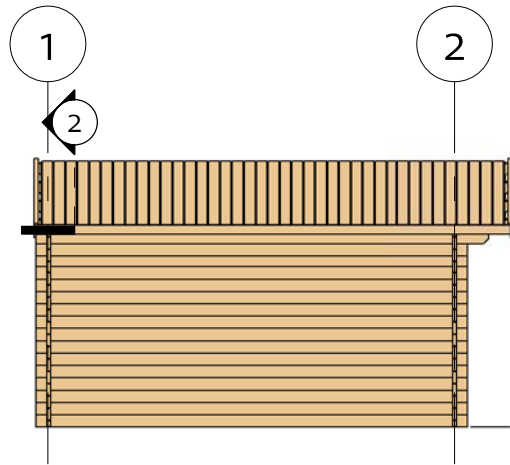

Fascia Schedule				
Mark	Type	Profile	Count	Length
EE	Eave Edging 18x40		4	2239
RF	Roof Fascia 18x115		4	2239
RR1	Roof reinforcement 18x90		2	4400
RR2	Roof reinforcement 38x38		2	4400

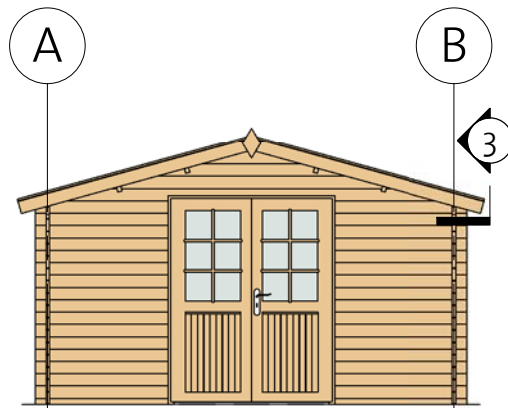

3 Roof Reinforcement

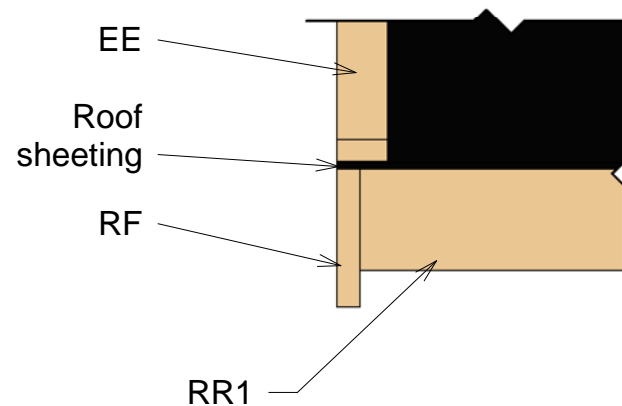

Osto Dresden 34

Extras

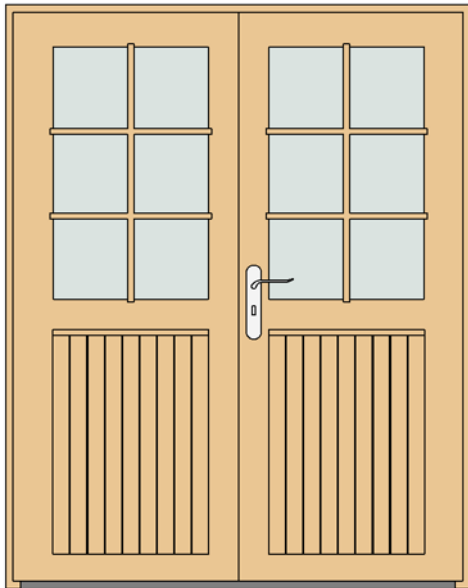

Door Schedule				
Mark	Type	Width	Height	Count
B34DD1	Basic 34 double door 1	1425	1835	1
DCB6	Door Crossbar 6	--	--	2

Fasteners/Extras		
Name	Type	Count

Hitblock	300-400 mm	
Screws	5,0 x 70	10
Bolts	M8 x 70	12
Screws	6,0 x 140	25
Screws	4,0 x 40	100
Screws	4,0 x 50	350

Type	Count	Length
Windboard 18x38	4	1900





Family	Count
Romb	2





Osto Dresden 34

List of all items 1

Fascia Schedule

Mark	Type	Profile	Count	Length
EE	Eave Edging 18x40		4	2239
RF	Roof Fascia 18x115		4	2239
RR1	Roof reinforcement 18x90		2	4400
RR2	Roof reinforcement 38x38		2	4400

Roof

Mark	Type	Profile	Count	Length
RFR	Ridge 40x143		1	4400
RFB	Beam 40x143		4	4400
RB	18x110		82	2197

Osto Dresden 34

List of all items 2

Wall 1			
Mark	Profile	Count	Cut Length

1BL-1	34X57	1	4000
1LG-1 *	34X114	1	831
1LG-2 *	34X114	1	1660
1LG-3 *	34X114	1	2471
1LG-4 *	34X114	1	3318
1LG-5	34X114	16	4000
1LG-6 *	34X114	1	4000

Wall 2			
Mark	Profile	Count	Cut Length

2BL-1	34X57	2	1280
2LG-1 *	34X114	1	831
2LG-2	34X114	32	1280
2LG-3 *	34X114	1	1660
2LG-4 *	34X114	1	2471
2LG-5 *	34X114	1	3318
2LG-6 *	34X114	1	4000

* Gable - delivered premounted



Wall A			
Mark	Profile	Count	Cut Length

ALG-1	34X114	15	4000
ALG-2	34X114	1	4200
ATL-1	34X114	1	4400

Wall B			
Mark	Profile	Count	Cut Length

BLG-1	34X114	15	4000
BLG-2	34X114	1	4200
BTL-1	34X114	1	4400

Log Profiles	
Profile	Profile

34X57	
34X114	
34X114	