

# Nipissing Bunkie 2 40 (315x315)

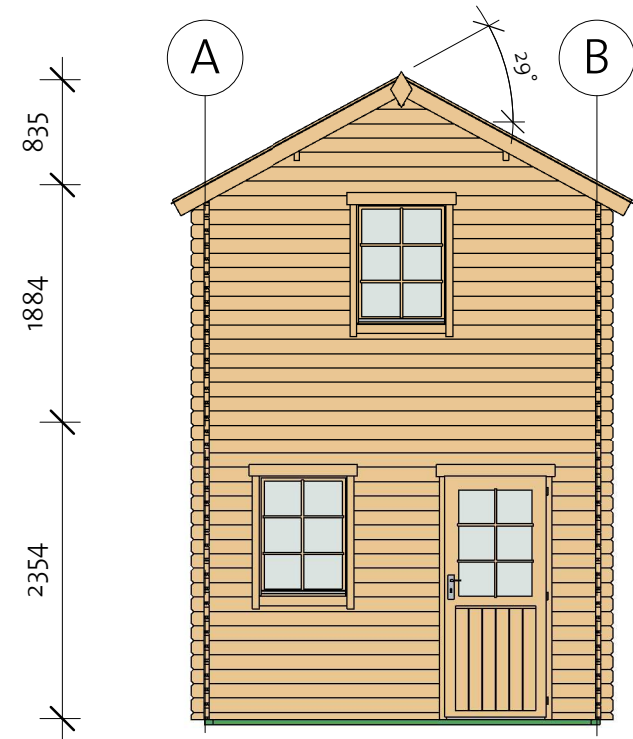

# Nipissing Bunkie 2 40 (315x315)

Foundation

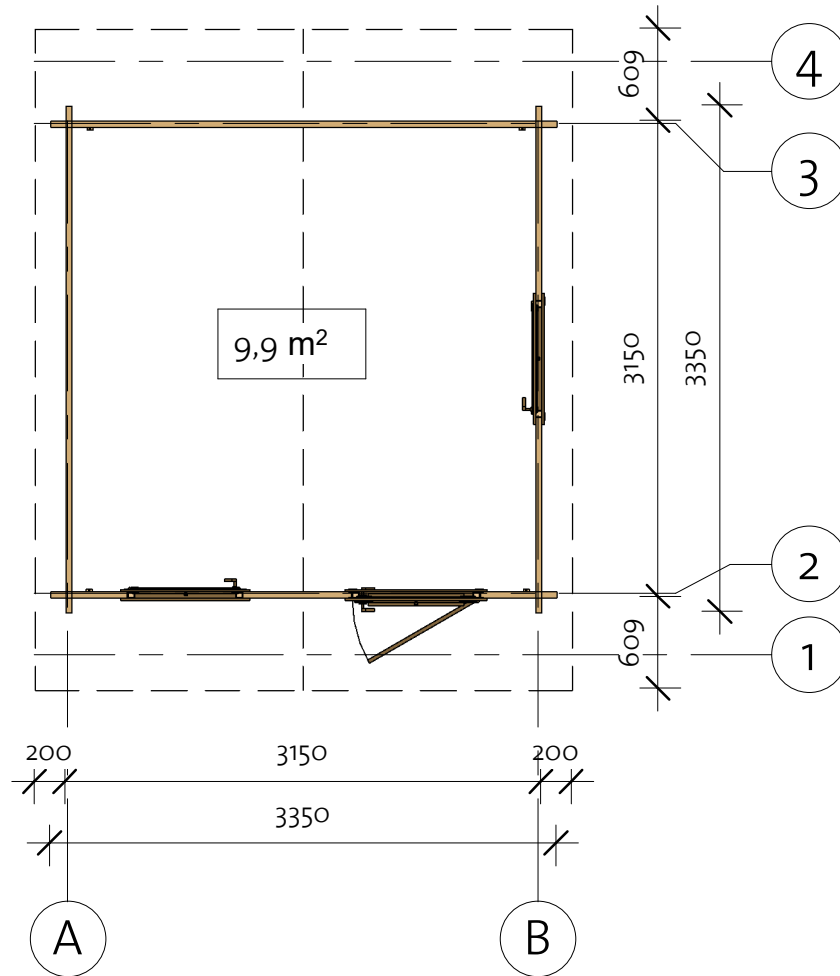
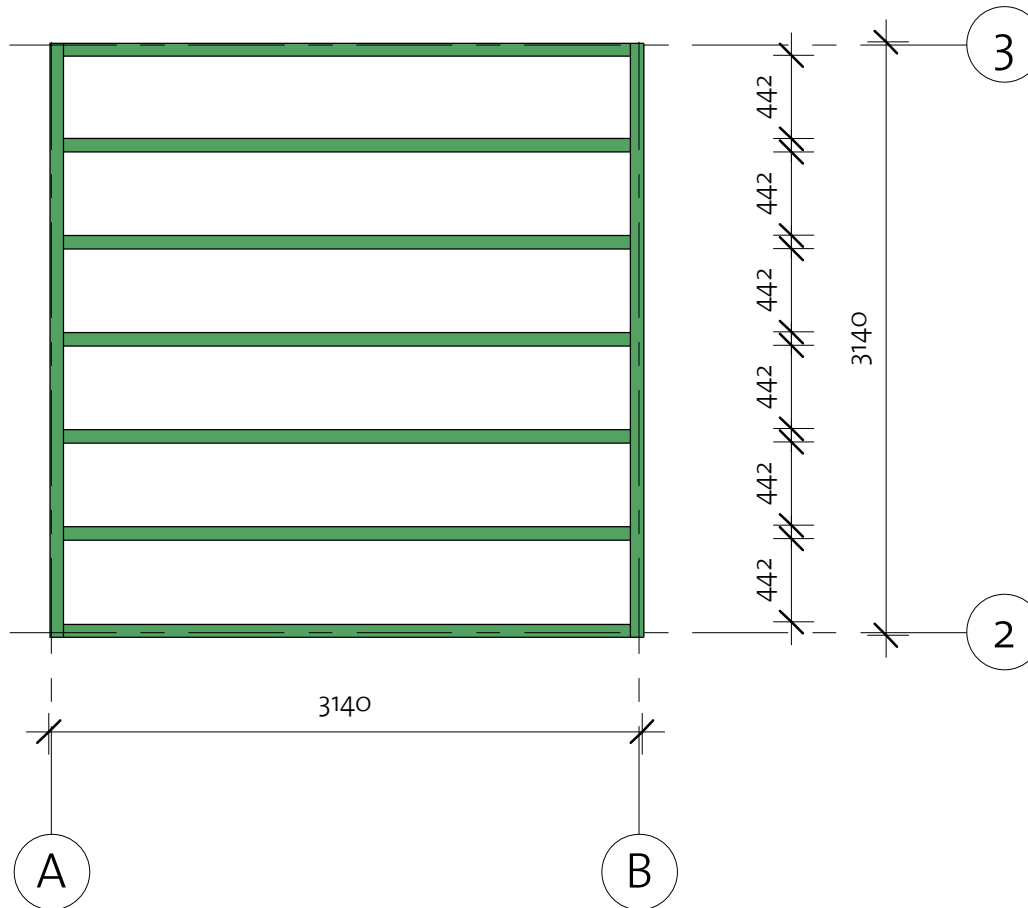

Impregnated foundation beams				
Mark	Type	Profile	Count	Length

IFB1	IFB 70x40		2	3140
IFB2	IFB 70x40		7	3000

# Nipissing Bunkie 2 40 (315x315)

Floor Plan

① Baseboard

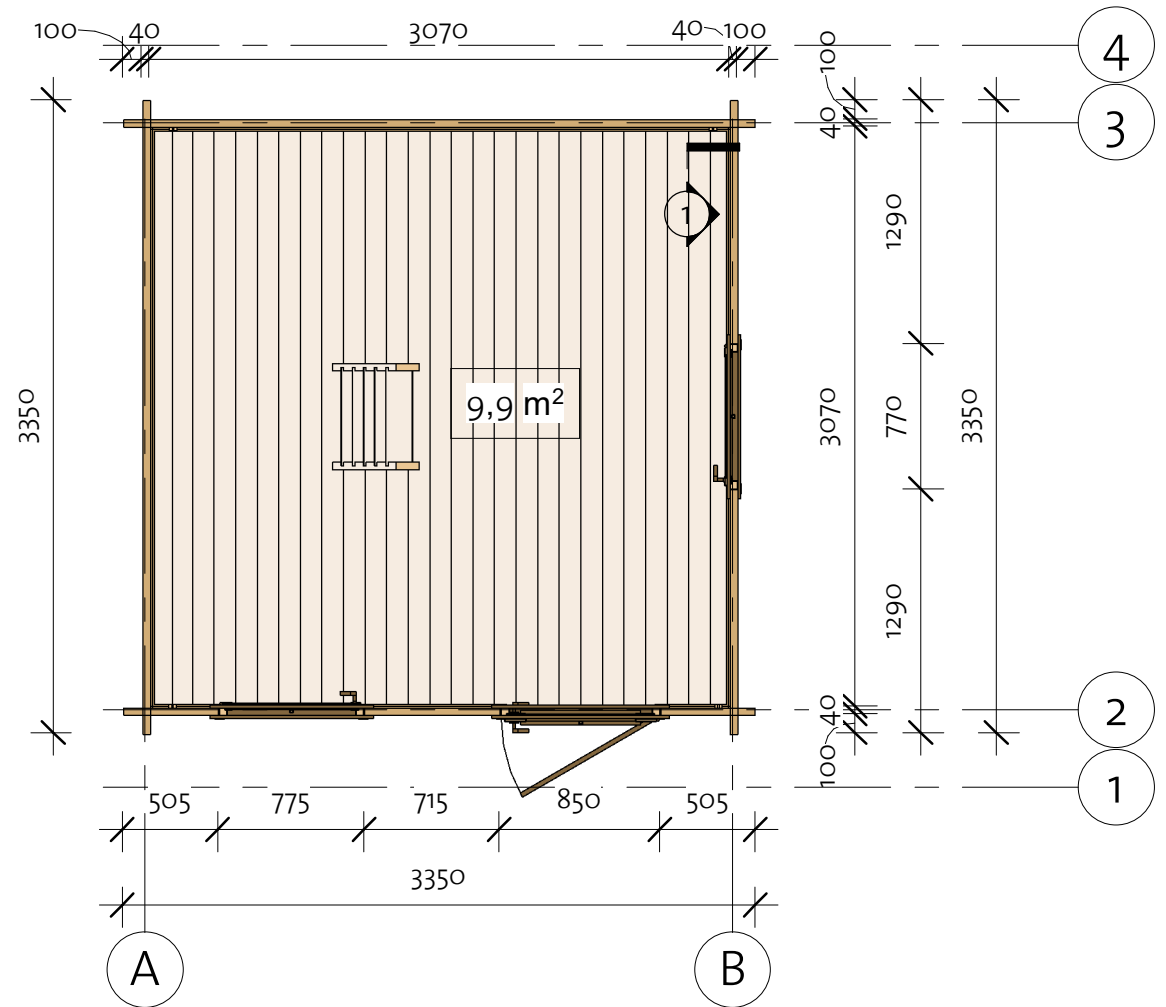
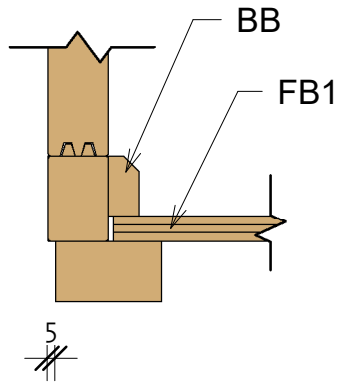

Floor Schedule

Mark	Type	Profile	Count	Length
FB1	FB 17x114		28	3064
BB1	BB 20x40		2	4000
BB2	BB 20x40		6	3200

# Nipissing Bunkie 2 40 (315x315)

Wall 1

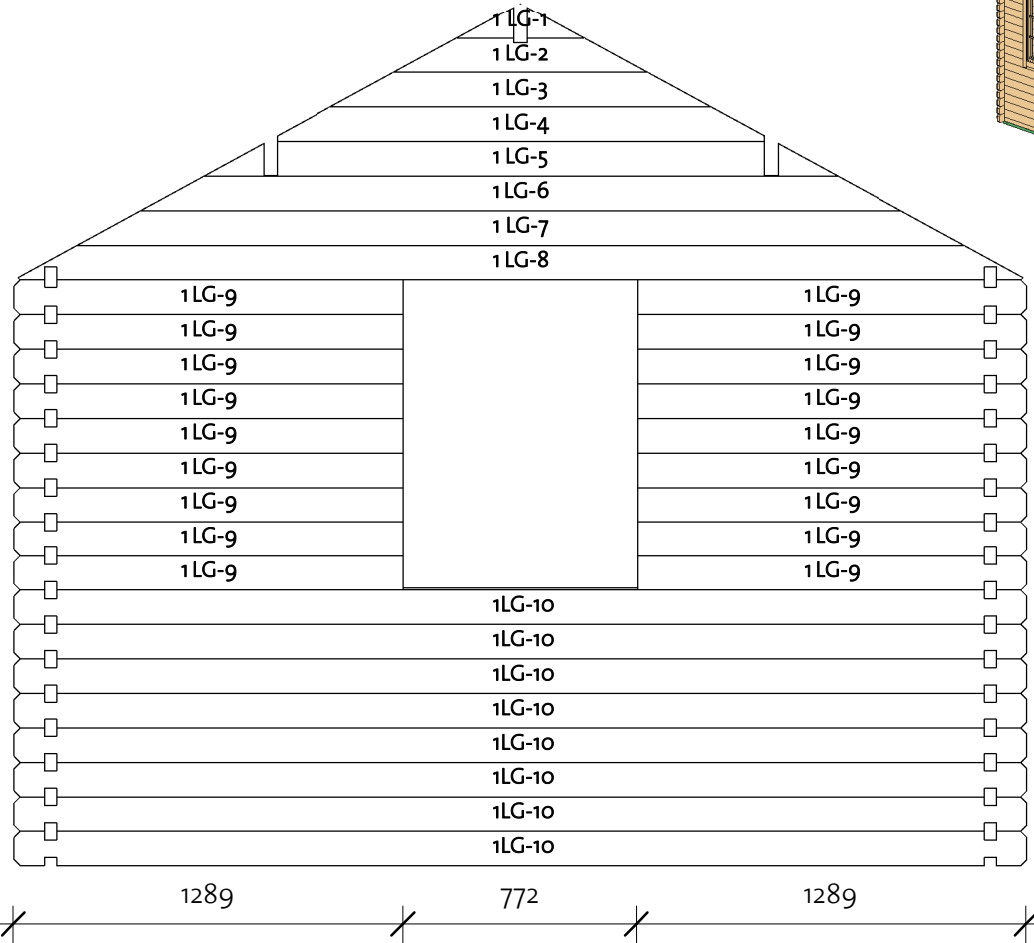
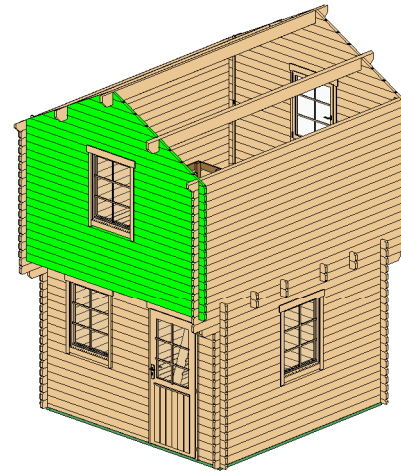

Wall 1			
Mark	Profile	Count	Cut Length

1LG-1 *	40X114	1	420
1LG-2 *	40X114	1	839
1LG-3 *	40X114	1	1258
1LG-4 *	40X114	1	1610
1LG-5 *	40X114	1	2096
1LG-6 *	40X114	1	2515
1LG-7 *	40X114	1	2934
1LG-8 *	40X114	1	3325
1LG-9	40X114	18	1289
1LG-10	40X114	8	3350

\* Gable - delivered premounted

Log Profile Wall 1	
Profile	Profile

40X114	
--------	--

# Nipissing Bunkie 2 40 (315x315)

Wall 2

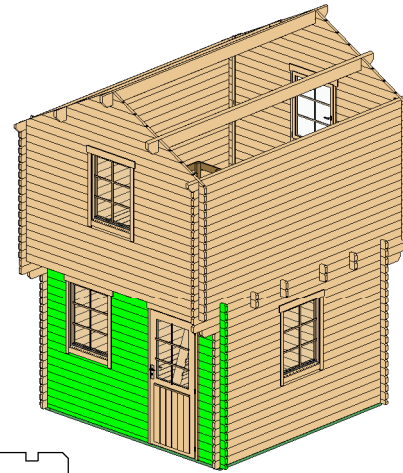

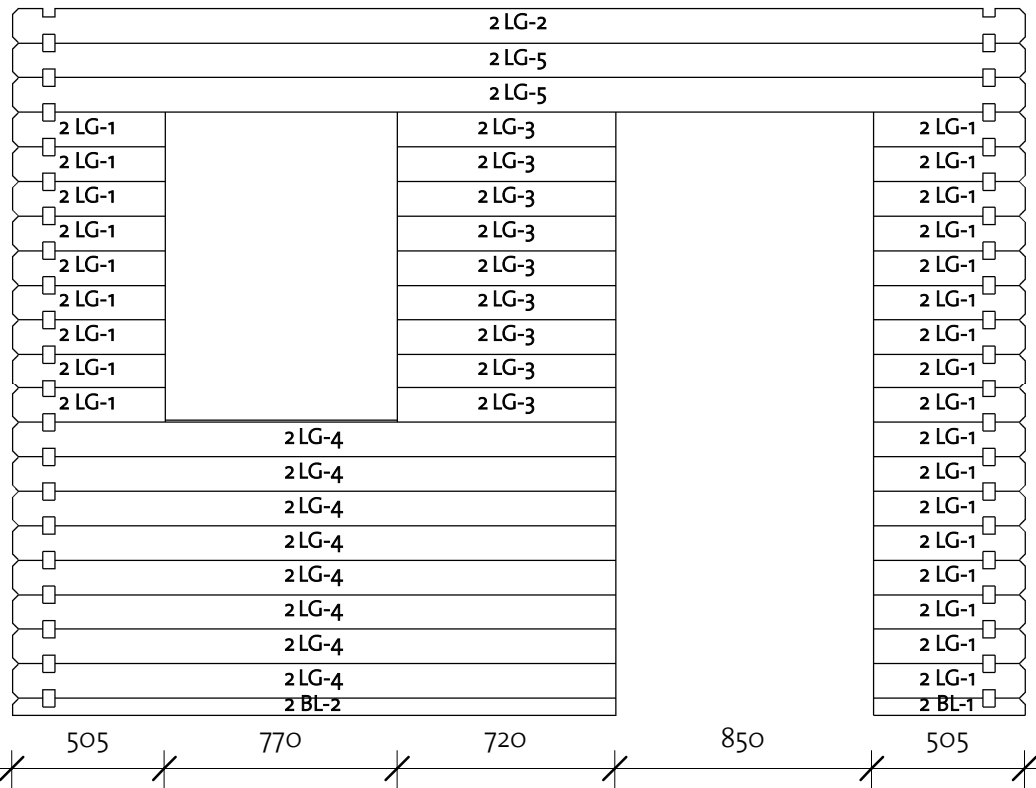

Wall 2			
Mark	Profile	Count	Cut Length

2BL-1	40X57	1	505
2BL-2	40X57	1	1995
2LG-1	40X114	26	505
2LG-2	40X114	1	3350
2LG-3	40X114	9	720
2LG-4	40X114	8	1995
2LG-5	40X114	2	3350



Log Profile Wall 2	
Profile	Profile

40X57	
40X114	
40X114	

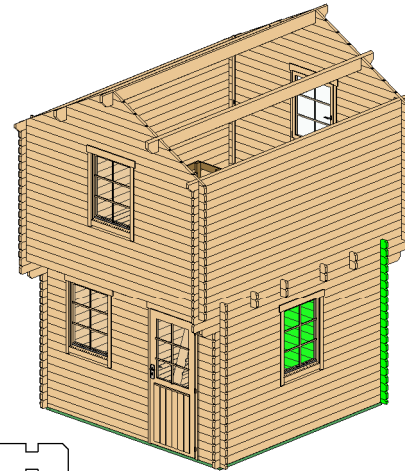

# Nipissing Bunkie 2 40 (315x315)

Wall 3



	3 LG-2	
	3 LG-1	
	3 LG-1	
	3 LG-1	
	3 LG-1	
	3 LG-1	
	3 LG-1	
	3 LG-1	
	3 LG-1	
	3 LG-1	
	3 LG-1	
	3 LG-1	
	3 LG-1	
	3 LG-1	
	3 LG-1	
	3 LG-1	
	3 LG-1	
	3 LG-1	
	3 LG-1	
	3 LG-1	
	3 BL-1	

Wall 3			
Mark	Profile	Count	Cut Length
3BL-1	40x57	1	3350
3LG-1	40x114	19	3350
3LG-2	40x114	1	3350

Log Profile Wall 3	
Profile	Profile
40x57	
40x114	
40x114	

# Nipissing Bunkie 2 40 (315x315)

Wall 4

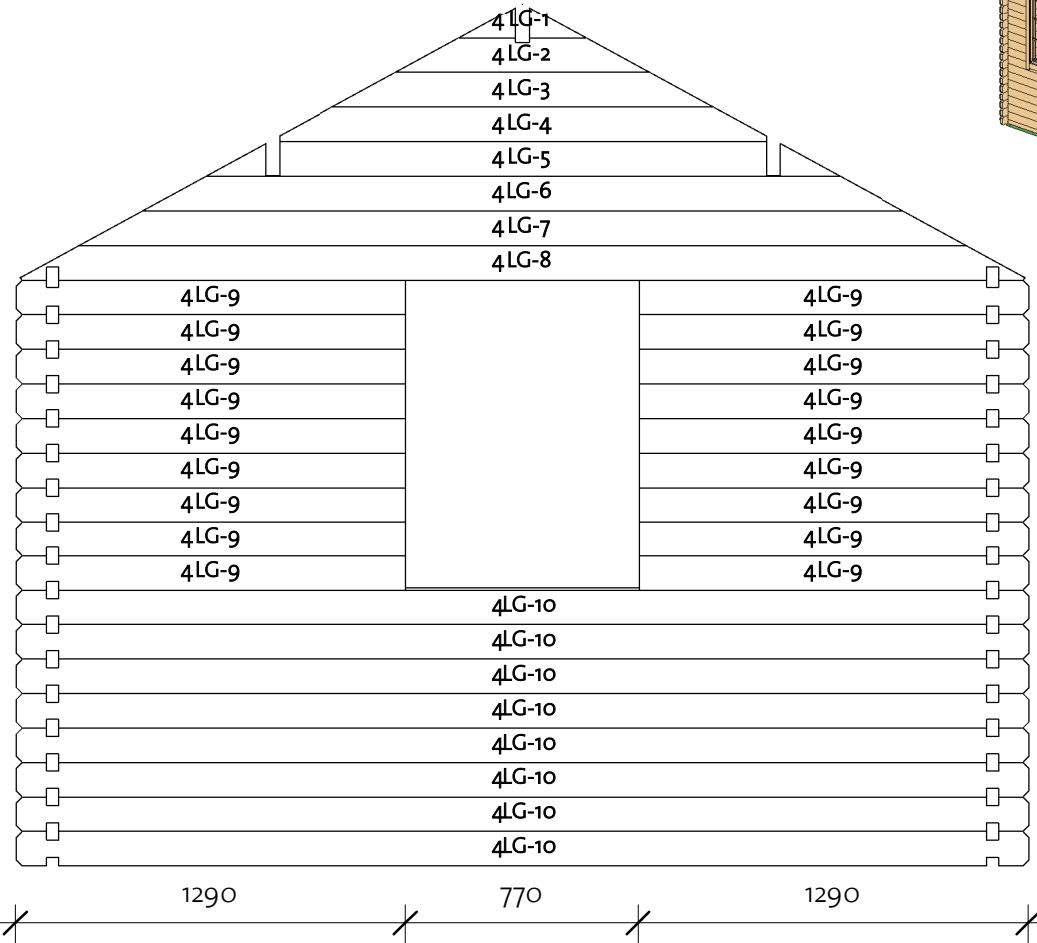
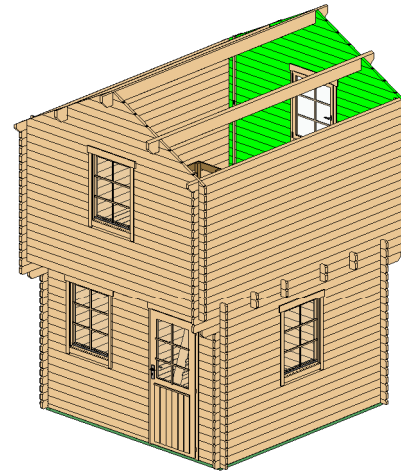

Wall 4			
Mark	Profile	Count	Cut Length

4LG-1 *	40X114	1	420
4LG-2 *	40X114	1	839
4LG-3 *	40X114	1	1258
4LG-4 *	40X114	1	1610
4LG-5 *	40X114	1	2096
4LG-6 *	40X114	1	2515
4LG-7 *	40X114	1	2934
4LG-8 *	40X114	1	3325
4LG-9	40X114	18	1290
4LG-10	40X114	8	3350

\* Gable - delivered premounted

Log Profile Wall 4	
Profile	Profile

40X114	
--------	---

# Nipissing Bunkie 2 40 (315x315)

Wall A

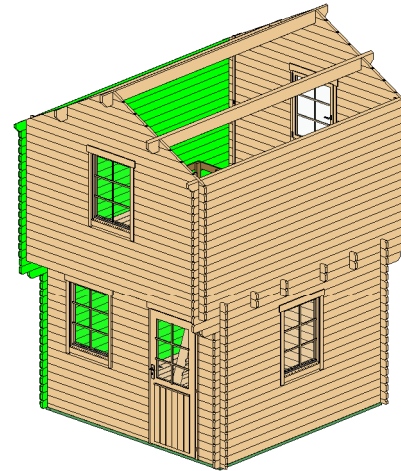
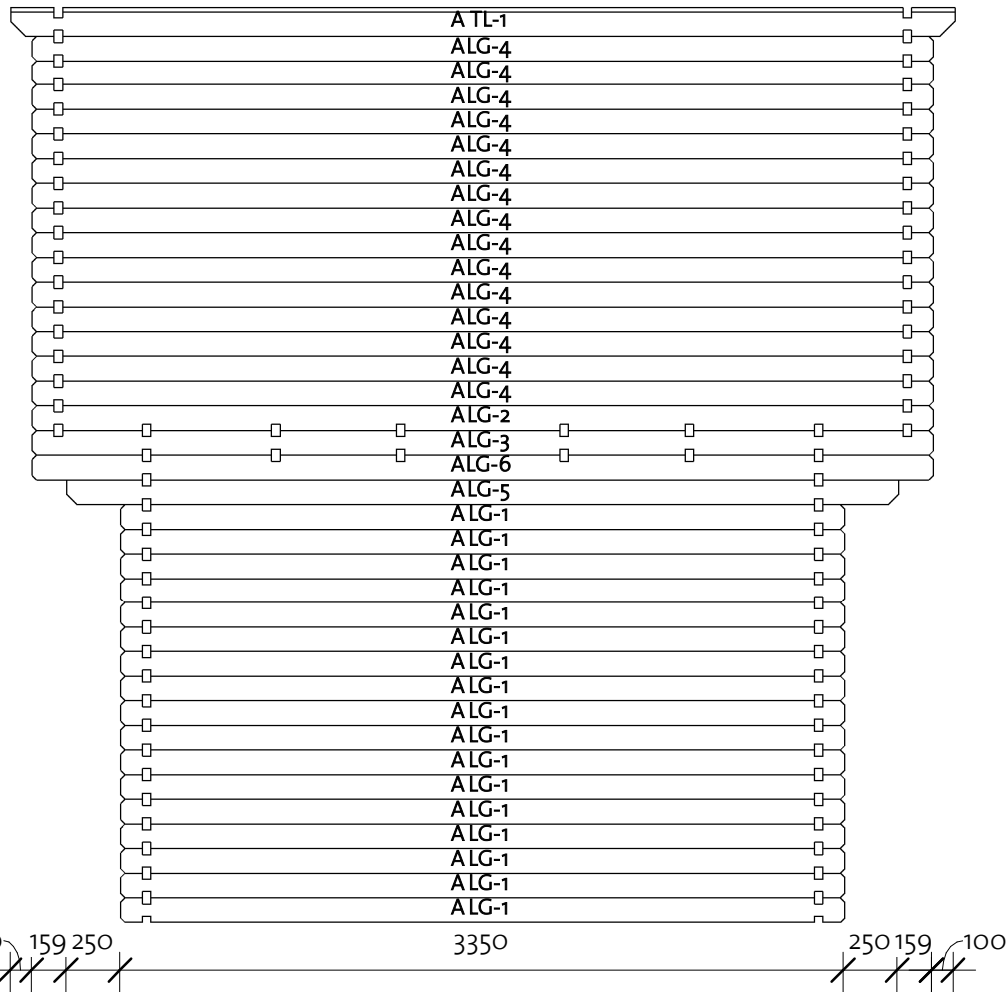

Wall A			
Mark	Profile	Count	Cut Length

ALG-1	40X114	17	3350
ALG-2	40X114	1	4168
ALG-3	40X114	1	4168
ALG-4	40X114	15	4168
ALG-5	40X114	1	3850
ALG-6	40X114	1	4168
ATL-1	40X134	1	4368

Log Profile Wall A	
Profile	Profile

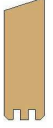
40X114	
40X134	

92102232\_210622



# Nipissing Bunkie 2 40 (315x315)

Wall B

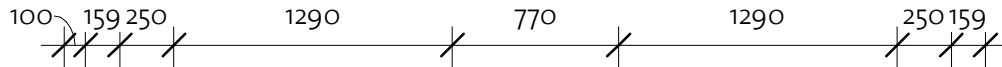
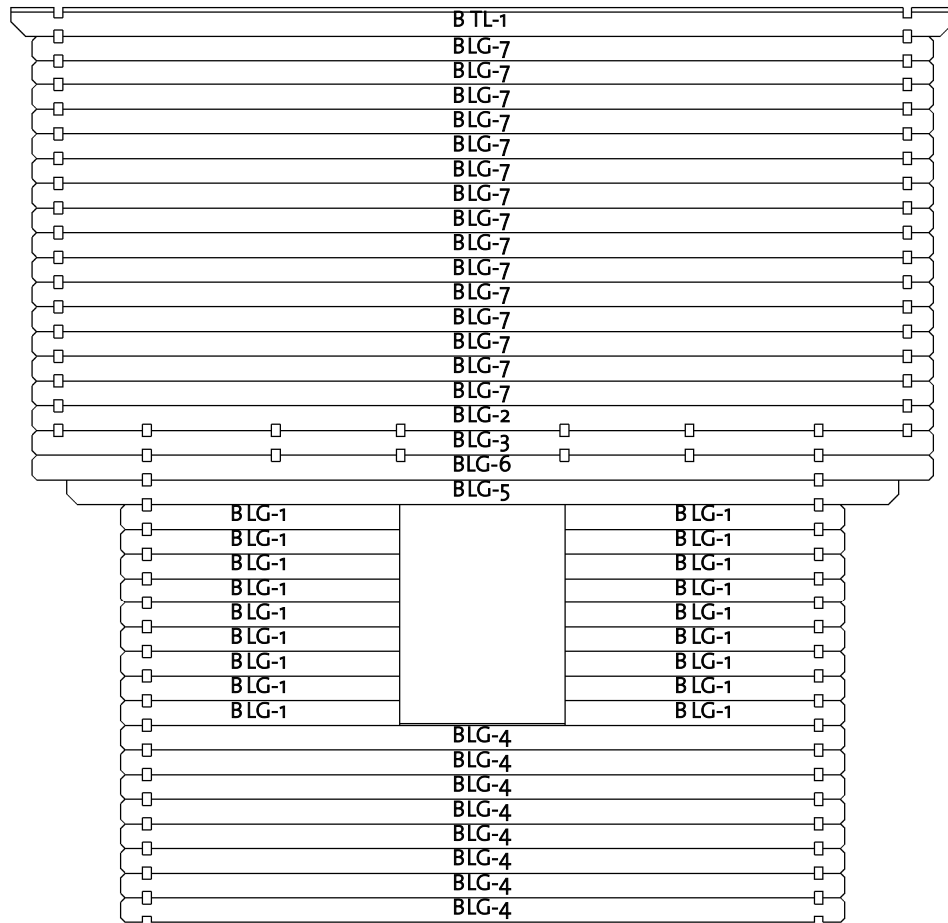

92102232\_210622

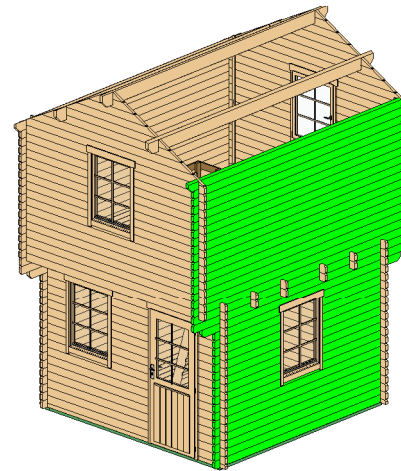

Wall B

Mark	Profile	Count	Cut Length
------	---------	-------	------------

BLG-1	40X114	18	1290
BLG-2	40X114	1	4168
BLG-3	40X114	1	4168
BLG-4	40X114	8	3350
BLG-5	40X114	1	3850
BLG-6	40X114	1	4168
BLG-7	40X114	15	4168
BTL-1	40X134	1	4368

Log Profile Wall B

Profile	Profile
---------	---------

40X134

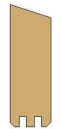



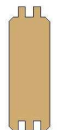

40X114

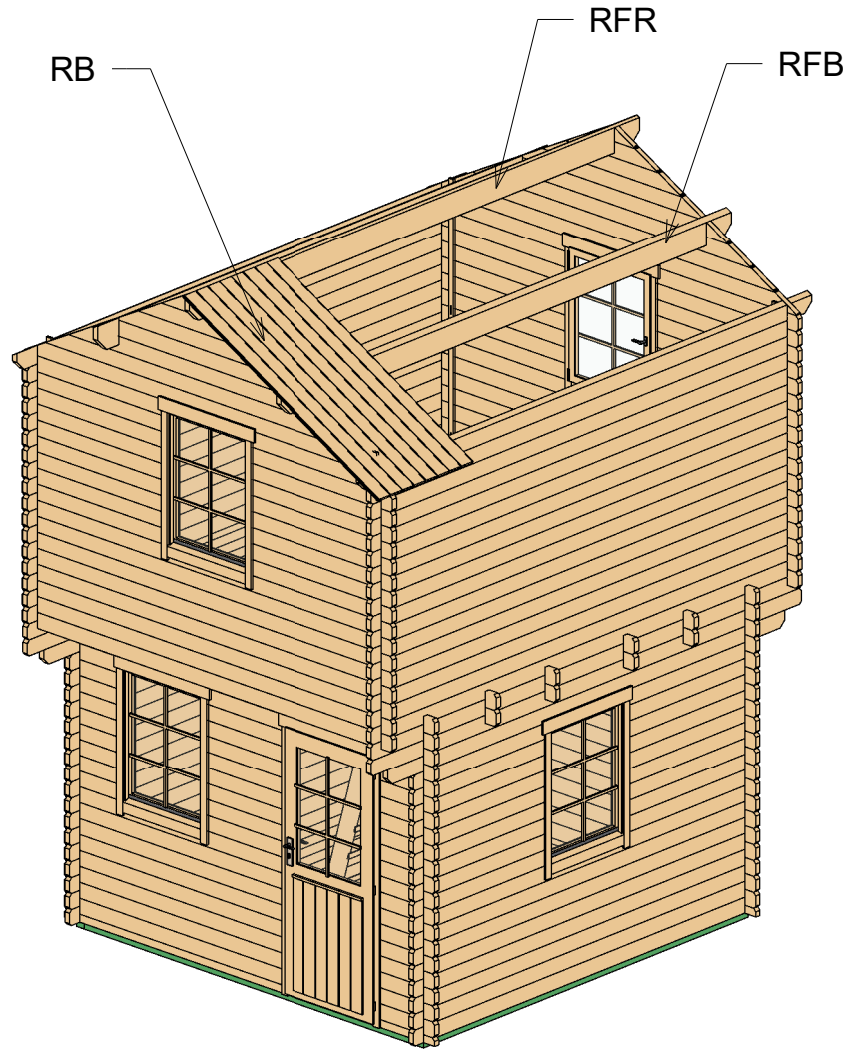

# Nipissing Bunkie 2 40 (315x315)

Roof 1



Roof				
Mark	Type	Profile	Count	Length
RFR	Ridge 45x195		1	4368
RFB	Beam 45x195		2	4368
RB	17x114		80	2012

# Nipissing Bunkie 2 40 (315x315)

Roof 2

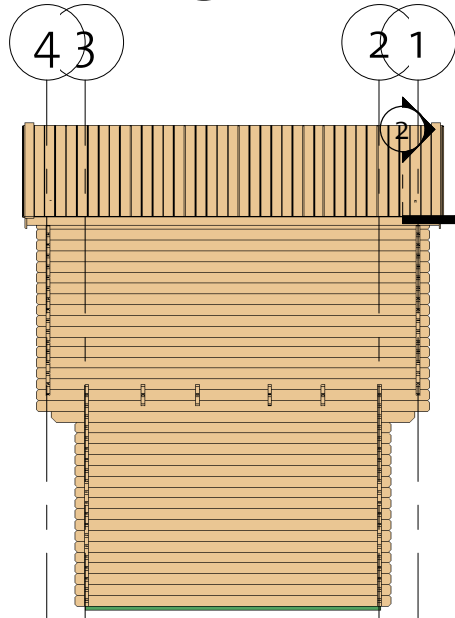

② Facia

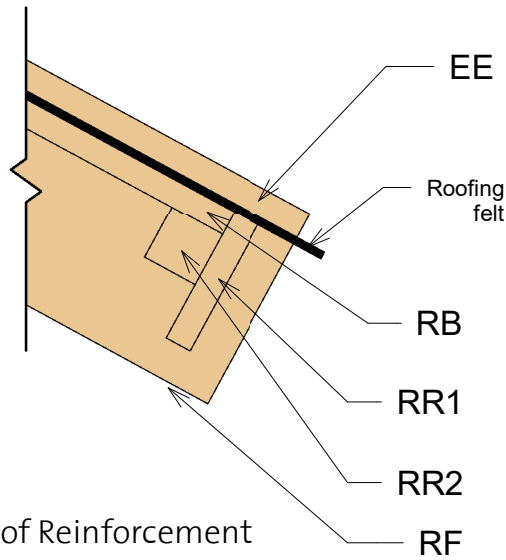

③ Roof Reinforcement

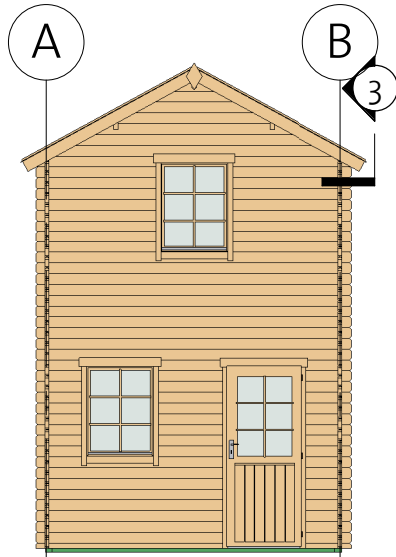
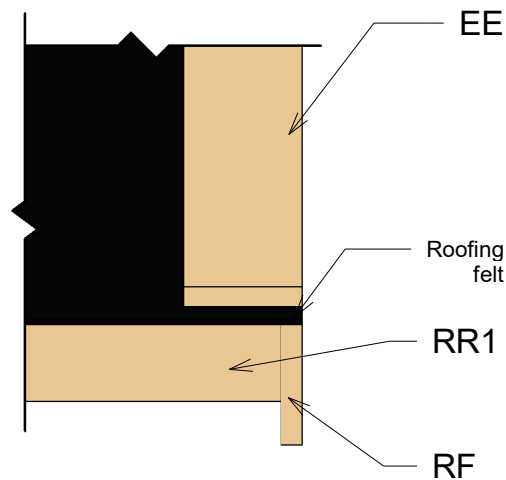

Fascia Schedule

Mark	Type	Profile	Count	Length
EE	Eave Edging 18x95		4	2066
RF	Roof Fascia 18x120		4	2066
RR1	Roof reinforcement 18x95		2	4368
RR2	Roof reinforcement 38x38		2	4368

# Nipissing Bunkie 2 40 (315x315)

Second floor 12,5 m2

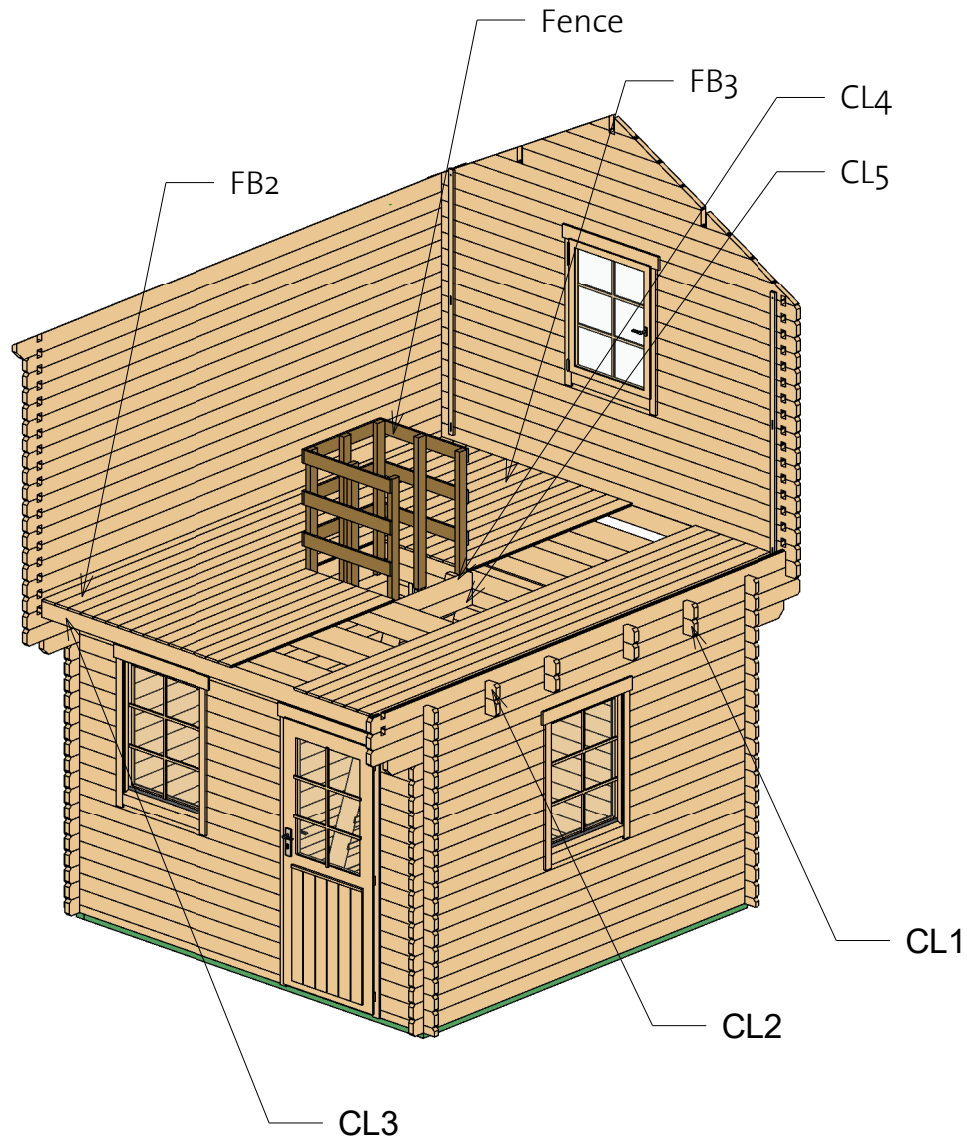

Second floor schedule				
Mark	Type	Profile	Length	Count
CL1	Log 40X114		3350	4
CL2	Log 40X114		3350	4
CL3	Log 40X114		3070	2
CL4	Log 40X114		722	2
CL5	Log 40X114		722	2

Second Floor Schedule				
Mark	Type	Profile	Count	Length

FB2	FB 17X114		21	3882
FB3	FB 17X114		14	1580

# Nipissing Bunkie 2 40 (315x315)

Fence

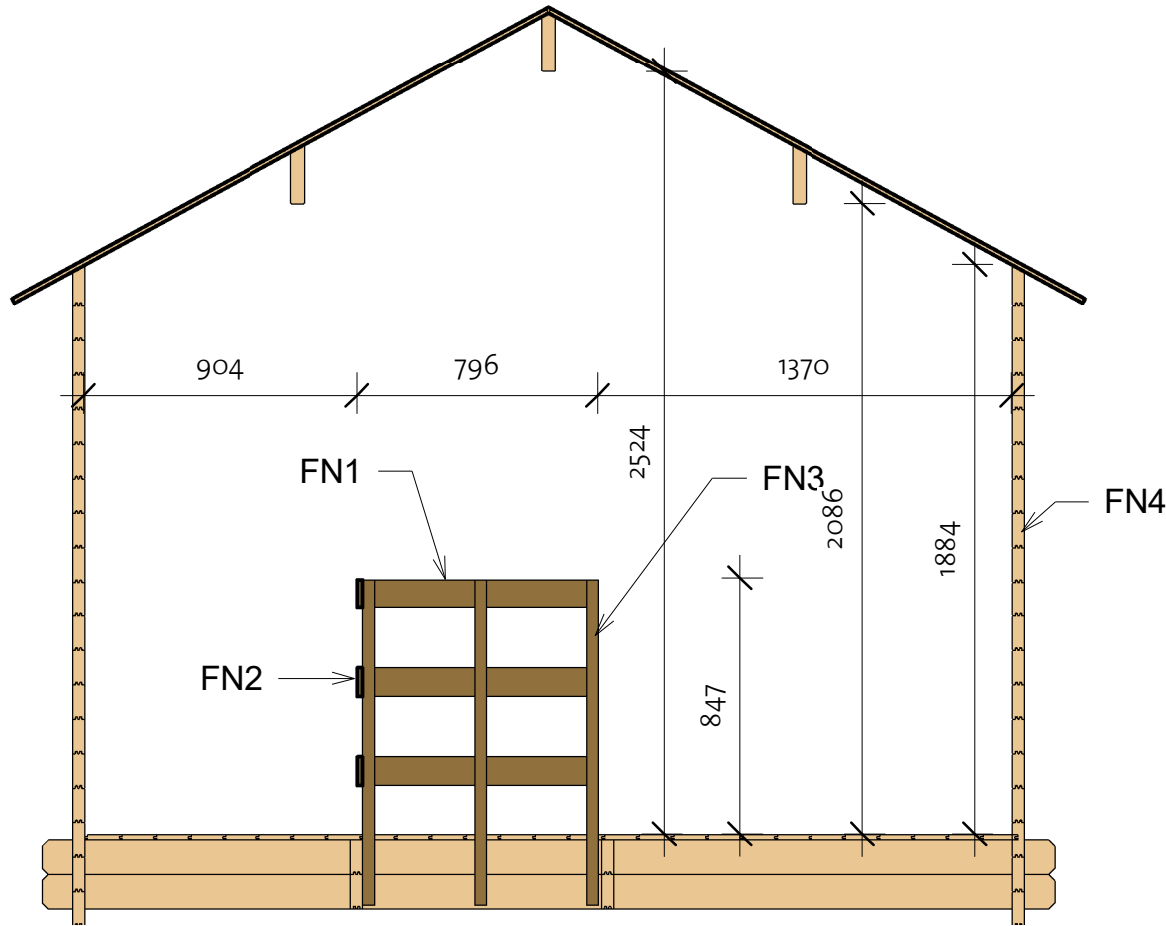

Fence schedule				
Mark	Type	Profile	Length	Count
FN1	Fence 18x95		778	6
FN2	Fence 18x95		758	3
FN3	Fence 40x70		1079	7

# Nipissing Bunkie 2 40 (315x315)

Stairs

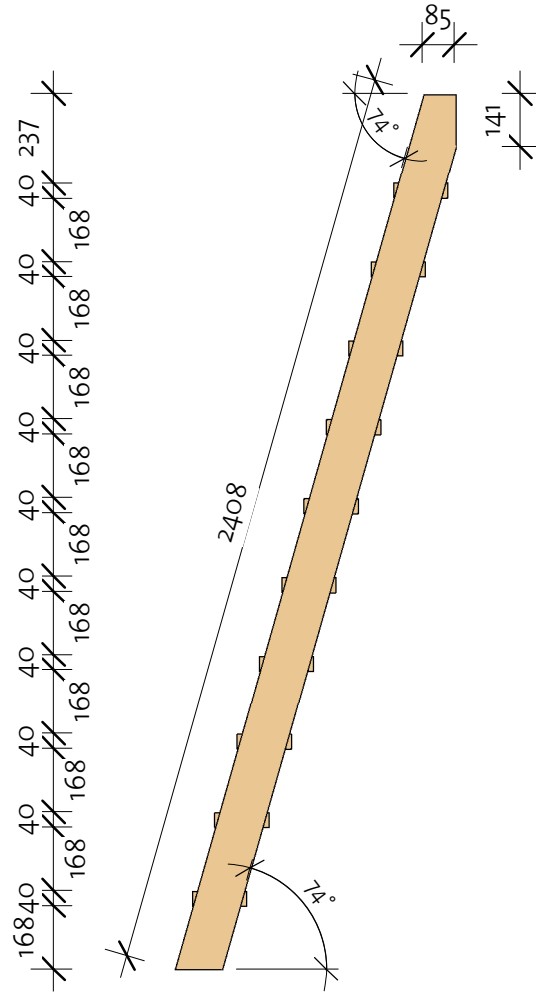
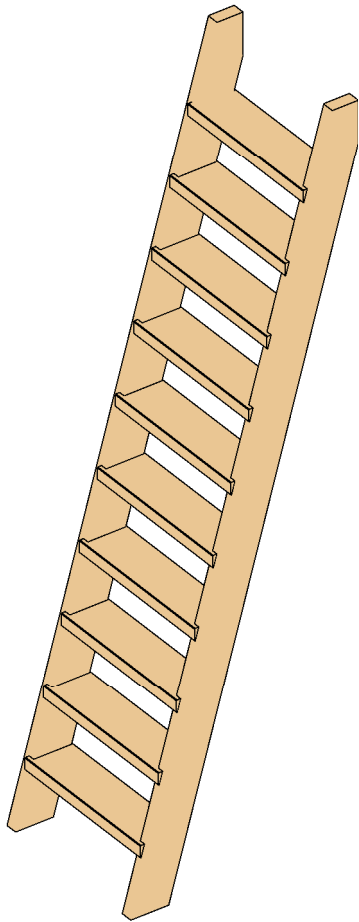

Stairs				
Mark	Profile	Profile	Count	Cut Length
ST1L	Stair 40X120		1	2431
ST1R	Stair 40X120		1	2431
ST2	Stair 143X40		10	520

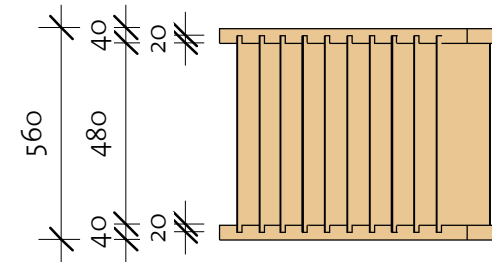

# Nipissing Bunkie 2 40 (315x315)

Extras

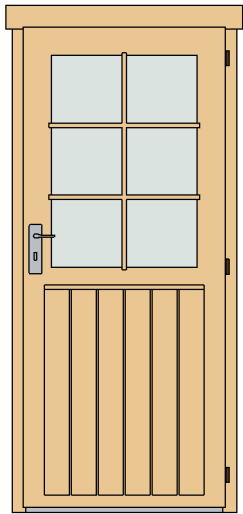

Door Schedule				
Model	Type	Width	Height	Count
CD4R	Classic door 4 right	840	1955	1
DCB6	Door Crossbar 6	--	--	1

Type	Count	Length
Windboard 18x40 2200	4	2200
Windboard 18x40x2300	4	2300

Type	Count
Romb	2



Fasteners/Extras		
Name	Type	Count

Hitblock	300-400 mm	
Ladder fittings		2
Bolts	M8 x 70	24
Screws	6,0 x 140	55
Nails	1,4 x 40	70
Screws	5,0 x 70	115
Screws	4,0 x 40	130
Screws	4,0 x 50	750

Window Schedule				
Mark	Type	Width	Height	Count
CW1L	Classic window 1 left	765	990	2
CW1R	Classic window 1 right	765	990	2
WCB6	Windows Crossbar 6	--	--	4

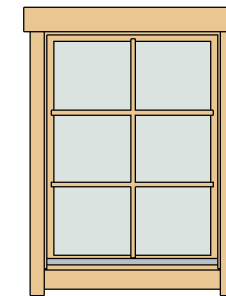





# Nipissing Bunkie 2 40 (315x315)

## List of all items 1

### Impregnated foundation beams

Mark	Type	Profile	Count	Length
IFB1	IFB 70x40		2	3140
IFB2	IFB 70x40		7	3000

### Fascia Schedule



Mark	Type	Profile	Count	Length
EE	Eave Edging 18x95		4	2066
RF	Roof Fascia 18x120		4	2066
RR1	Roof reinforce ment 18x95		2	4368
RR2	Roof reinforce ment 38x38		2	4368

### Floor Schedule

Mark	Type	Profile	Count	Length
FB1	FB 17x114		28	3064

BB1	BB 20x40		2	4000
BB2	BB 20x40		6	3200



### Roof



Mark	Type	Profile	Count	Length
RFR	Ridge 45x195		1	4368
RFB	Beam 45x195		2	4368
RB	17x114		80	2012



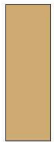
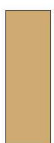

# Nipissing Bunkie 2 40 (315X315)

## List of all items 2

Stairs				
Mark	Profile	Profile	Count	Cut Length
ST1L	Stair 40X120		1	2431
ST1R	Stair 40X120		1	2431
ST2	Stair 143X40		10	520

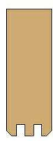
Fence schedule				
Mark	Type	Profile	Length	Count
FN1	Fence 18x95		778	6
FN2	Fence 18x95		758	3
FN3	Fence 40x70		1079	7

Second floor schedule				
Mark	Type	Profile	Length	Count
CL1	Log 40X114		3350	4
CL2	Log 40X114		3350	4
CL3	Log 40X114		3070	2
CL4	Log 40X114		722	2
CL5	Log 40X114		722	2

Second Floor Schedule				
Mark	Type	Profile	Count	Length
FB2	FB 17X114		21	3882
FB3	FB 17X114		14	1580

# Nipissing Bunkie 2 40 (315X315)

## List of all items 3

Wall 1			
Mark	Profile	Count	Cut Length

1LG-1 *	40X114	1	420
1LG-2 *	40X114	1	839
1LG-3 *	40X114	1	1258
1LG-4 *	40X114	1	1610
1LG-5 *	40X114	1	2096
1LG-6 *	40X114	1	2515
1LG-7 *	40X114	1	2934
1LG-8 *	40X114	1	3325
1LG-9	40X114	18	1289
1LG-10	40X114	8	3350

Wall 3			
Mark	Profile	Count	Cut Length

3BL-1	40X57	1	3350
3LG-1	40X114	19	3350
3LG-2	40X114	1	3350

\* Gable - delivered premounted

Wall 2			
Mark	Profile	Count	Cut Length

2BL-1	40X57	1	505
2BL-2	40X57	1	1995
2LG-1	40X114	26	505
2LG-2	40X114	1	3350
2LG-3	40X114	9	720
2LG-4	40X114	8	1995
2LG-5	40X114	2	3350

Wall 4			
Mark	Profile	Count	Cut Length

4LG-1 *	40X114	1	420
4LG-2 *	40X114	1	839
4LG-3 *	40X114	1	1258
4LG-4 *	40X114	1	1610
4LG-5 *	40X114	1	2096
4LG-6 *	40X114	1	2515
4LG-7 *	40X114	1	2934
4LG-8 *	40X114	1	3325
4LG-9	40X114	18	1290
4LG-10	40X114	8	3350

# Nipissing Bunkie 2 40 (315x315)

## List of all items 4

Wall A			
Mark	Profile	Count	Cut Length

ALG-1	40X114	17	3350
ALG-2	40X114	1	4168
ALG-3	40X114	1	4168
ALG-4	40X114	15	4168
ALG-5	40X114	1	3850
ALG-6	40X114	1	4168
ATL-1	40X134	1	4368

Wall B			
Mark	Profile	Count	Cut Length

BLG-1	40X114	18	1290
BLG-2	40X114	1	4168
BLG-3	40X114	1	4168
BLG-4	40X114	8	3350
BLG-5	40X114	1	3850
BLG-6	40X114	1	4168
BLG-7	40X114	15	4168
BTL-1	40X134	1	4368

Log profiles	
Profile	Profile

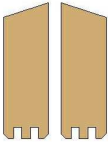
40X57	
40X134	

Log profiles	
Profile	Profile

40X114	
40X114	