

18
mm

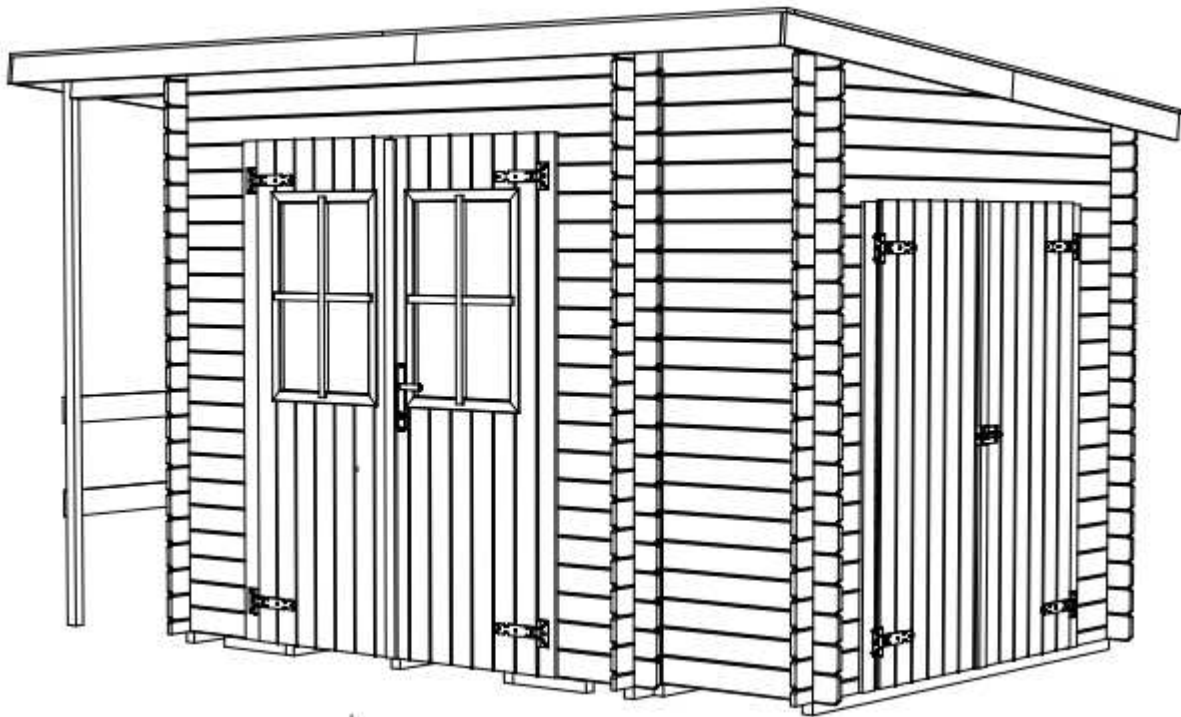

PROD.Nr.:



1415

Gartenpro Kft.
9444 Fertőszentmiklós
Soproni úti ipartelep
HUNGARY
16
1415-CPR-43-(C-80/2015)
ETA-15/0873
ETAG 007







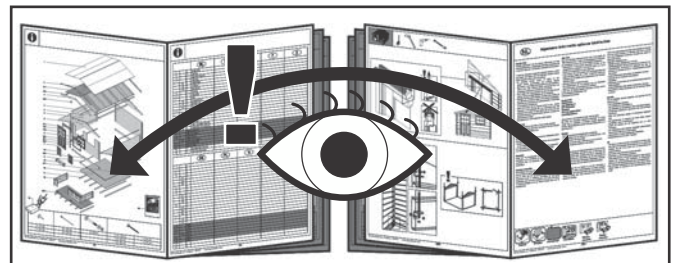

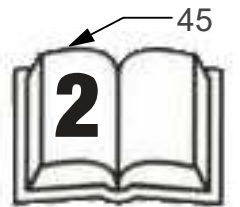
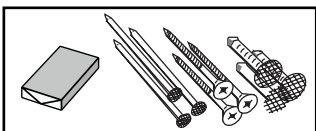
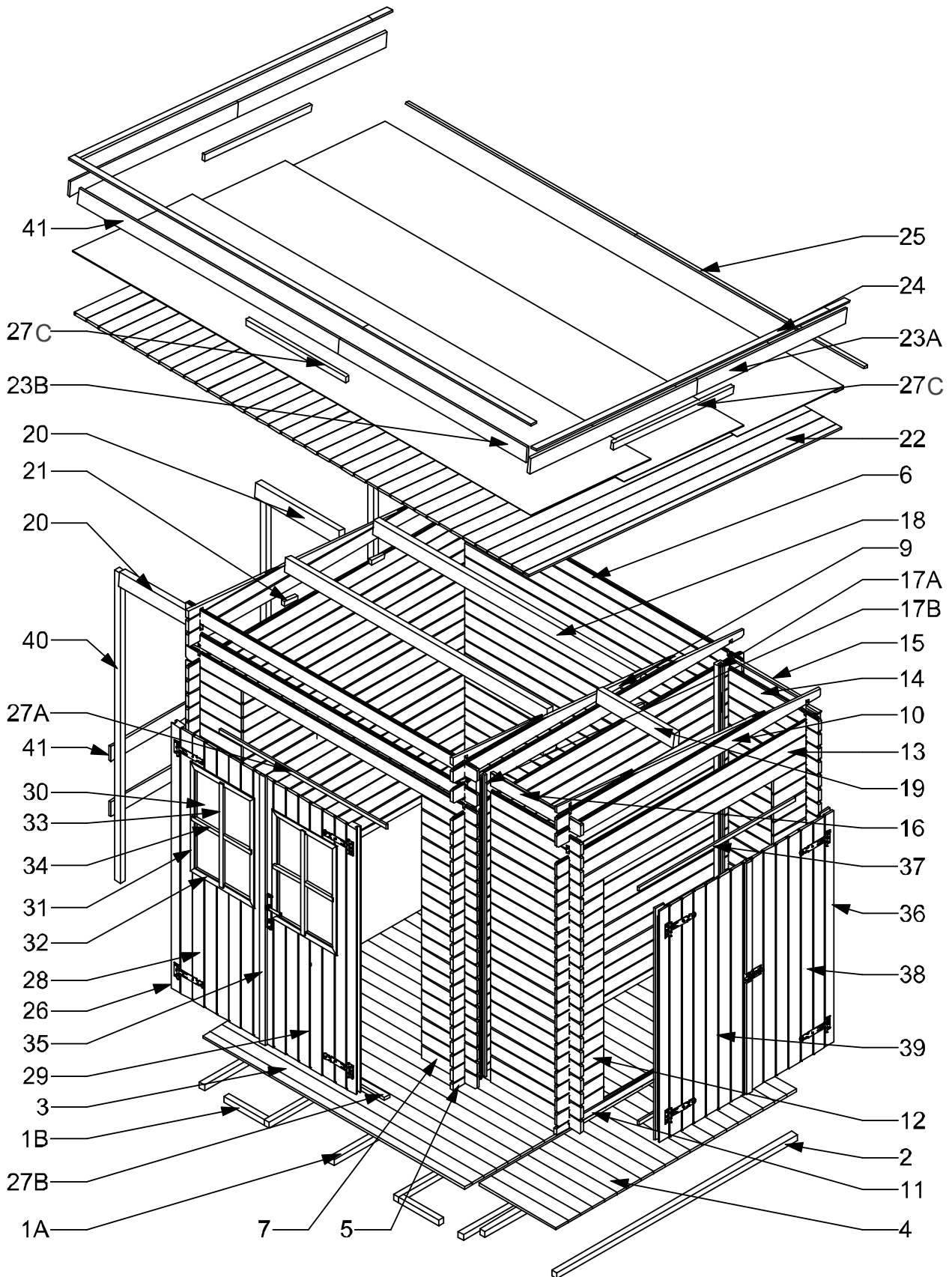





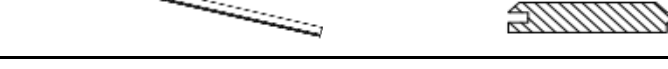

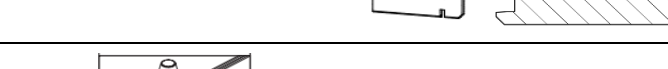

V 2020 18 PLT F1R1B0
Art.Nr.: 223202018
Ean.Nr. 5999553060874







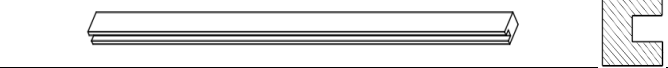
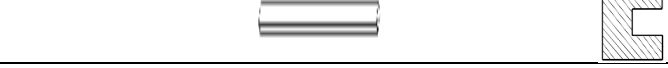
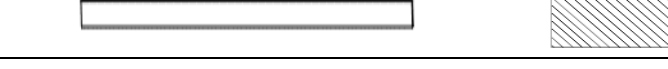
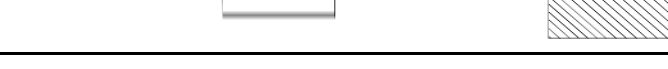























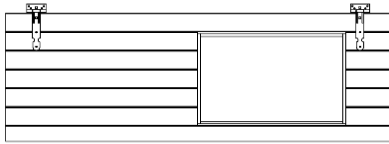
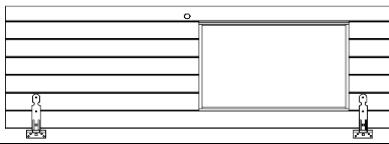





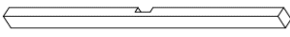

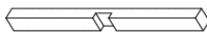





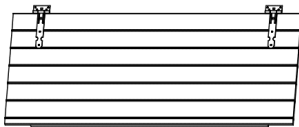
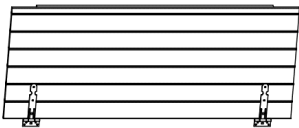

Hout voor Outdoor Life Products drokruiten en tuinhutten is vooral afkomstig uit gecertificeerde en goed beheerde bossen.
Wood used for our Outdoor Life Products cabins and garden houses is mostly sourced from certified and well-managed forests.
Das Holz für Outdoor Life Products Blockhäuschen und Gartenhäuser wird größtenteils aus zertifizierten Wäldern bezogen.
Les bois pour nos cabais et maisons de jardin de Outdoor Life Products proviennent en grande partie de forêts certifiées et gérées durablement.



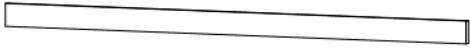

| | | | | |
|-----|-----------|--|-------------|-----|
| 1A | G60148011 |  | 38x38x2000 | 5X |
| 1B | G2227409 |  | 38x38x300 | 2X |
| 2. | G60148043 |  | 38x38x1800 | 2X |
| 3. | G2222275 |  | 15x99x1962 | 22X |
| 4. | G2222415 |  | 15x99x576 | 20X |
| 5. | G2222277 |  | 18X53X2180 | 2X |
| 6. | G2222283 |  | 18X98X2180 | 61X |
| 7. | G2223161 |  | 18X98X414 | 38X |
| 8. | G5157074 |  | 18X98X414 | 2X |
| 9. | G2223033 |  | 18x245x2180 | 2X |
| 10. | G2230155 |  | 18x240x1980 | 1X |
| 11. | G2222326 |  | 18X53X1980 | 1X |
| 12. | G2222342 |  | 18X98X354 | 32X |
| 13. | G2222350 |  | 18X98X1980 | 3X |
| 14. | G2222413 |  | 18X98X675 | 41X |
| 15. | G2230156 |  | 18X40X675 | 1X |
| 16. | G2230157 |  | 18X89X675 | 1X |
| 17A | G2223178 |  | 34x46x1795 | 2X |
| 17B | G2223083 |  | 34x46x165 | 1X |
| 18. | G2230158 |  | 43x90x1962 | 2X |
| 19. | G2222363 |  | 43x90x580 | 1X |
| 20. | G2230159 |  | 43x90x628 | 3X |

| | | | | |
|-----|----------------|---|------------------|-----|
| 21. | G2221304 |   | 20,6x27,6x150 | 4X |
| 22 | G2222364 |   | 15X99X2350 | 38X |
| 23A | G2223513 |   | 15X95X1260 | 4X |
| 23C | G2227270 |   | 15x95x1410 | 1X |
| 24. | G2223344 |   | 12x42x1820 | 5X |
| 25. | G60147540-1710 |   | 12X26X1710 | 2X |
| 26. | G2222339 |   | 42X68X1720 | 2X |
| 27A | G60147540-1250 |   | 12x26x1250 | 1X |
| 27B | G5156106-1250 |   | 20,6x40x1250 | 1X |
| 27C | G22230260 |   | 18x40x581 | 3X |
| 28. | G2230031 |  | 620X1710 zü | 1X |
| 29. | G2230032 |  | 620X1710 MIDI | 1X |
| 30. | G60199935 |  | 435X659X2 | 2X |
| 31. | G601470571-712 |   | 17x38x712 | 4X |
| 32. | G601470571-485 |   | 17x38x485 | 4X |
| 33. | G60463921K-673 |   | 19X25X673 | 2X |
| 34. | G60463921K-445 |   | 19X25X445 | 2X |
| 35. | G2222494 |   | 12x42x1740 | 2X |
| 36. | G2222412 |   | 42x68x1500 | 2X |
| 37. | G60147540-1172 |   | 12x26x1172 | 2X |
| 38. | G2230171 |  | 581x1500 | 1X |
| 39. | G2230172 |  | 581x1500 | 1X |

| | | | | |
|-----|---------------|---|--------------------|-------------------|
| 40. | G2221346-2010 |   | 34x46x2010 | 3X |
| 41. | G2222410 |   | 15x95x1950 | 3X |
| 42. | G2230286 |  | V2020 PLT | 1X |
| 43. | G2224748 |  | 1,0x12m | 1X |
| 44. | G6099908 |  | Building instr. | Útm. Építési 1X |
| 45. | G6065190 |  | General Conditions | Útm. Általános 1X |

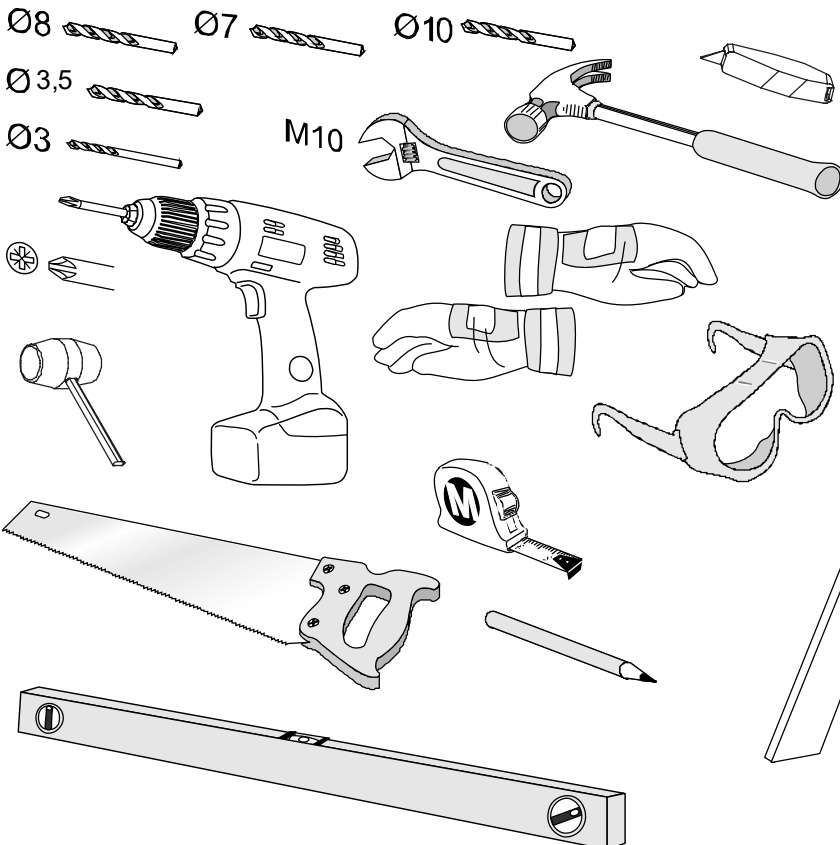
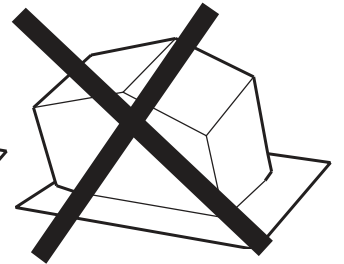
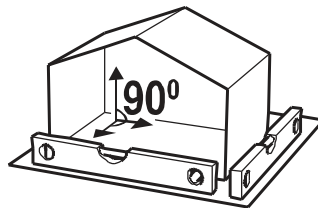
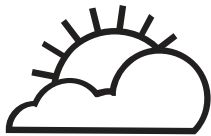
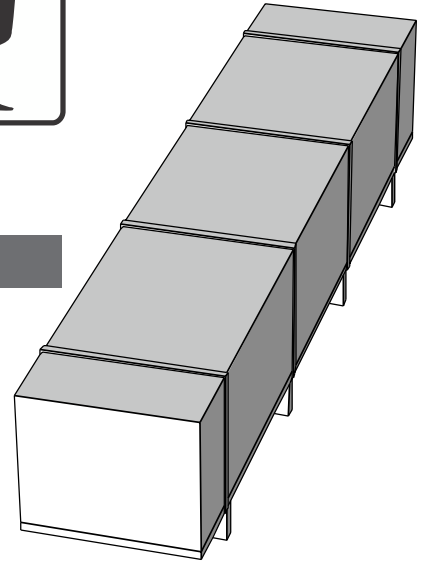
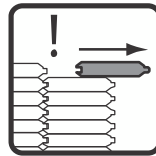
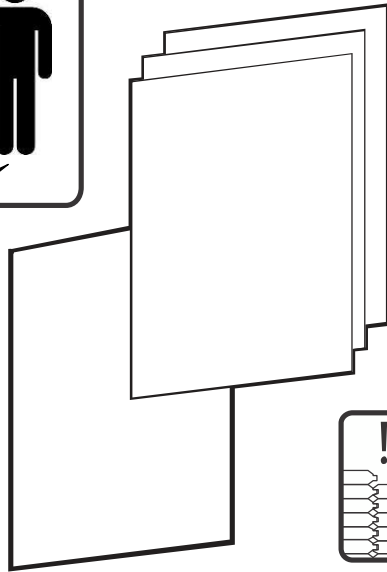
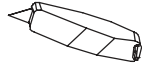
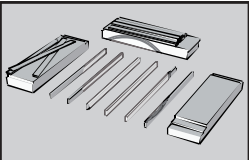

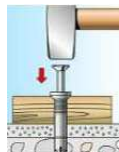
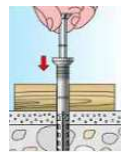
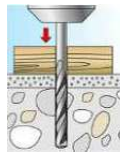
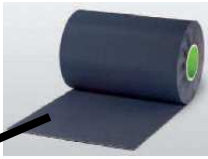
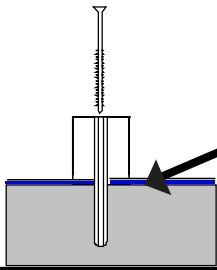
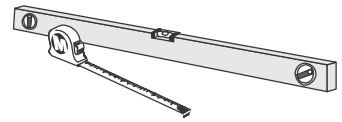
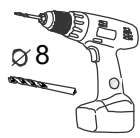

1





POS

1A  38x38x2000 5X

1B  38x38x300 2X

2.  38x38x1800 2X

 +€
 min25X
8x100mm

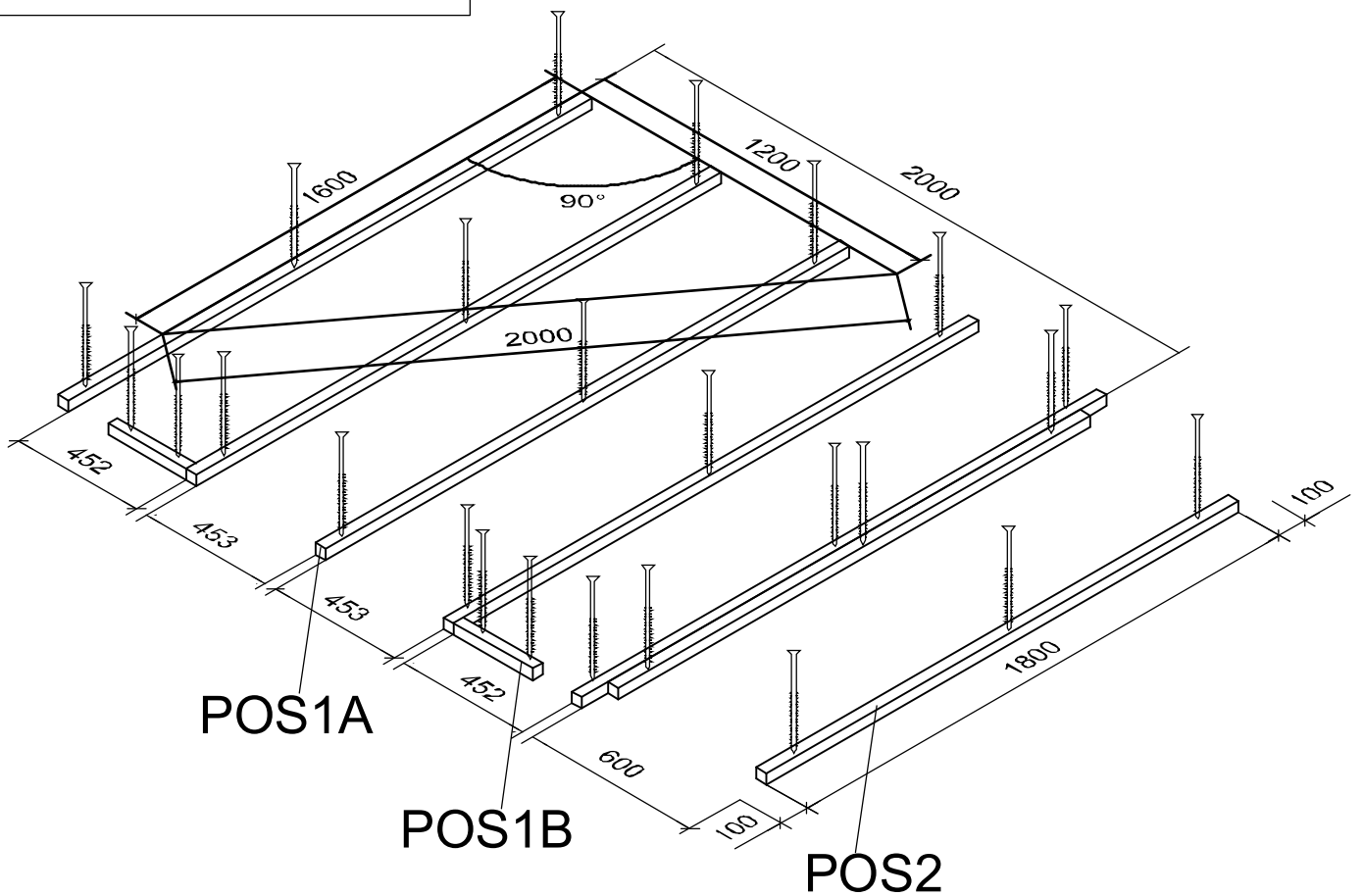

2

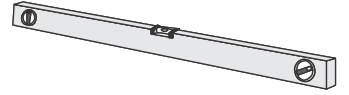
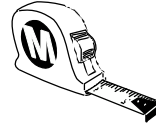
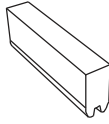
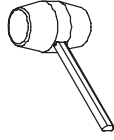
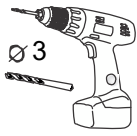

POS

5.  18x53x2180 2X

11.  18x53x1980 2X



9X

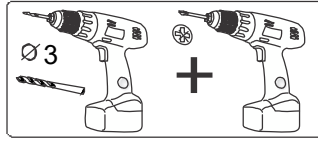

4x50mm

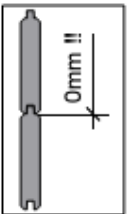
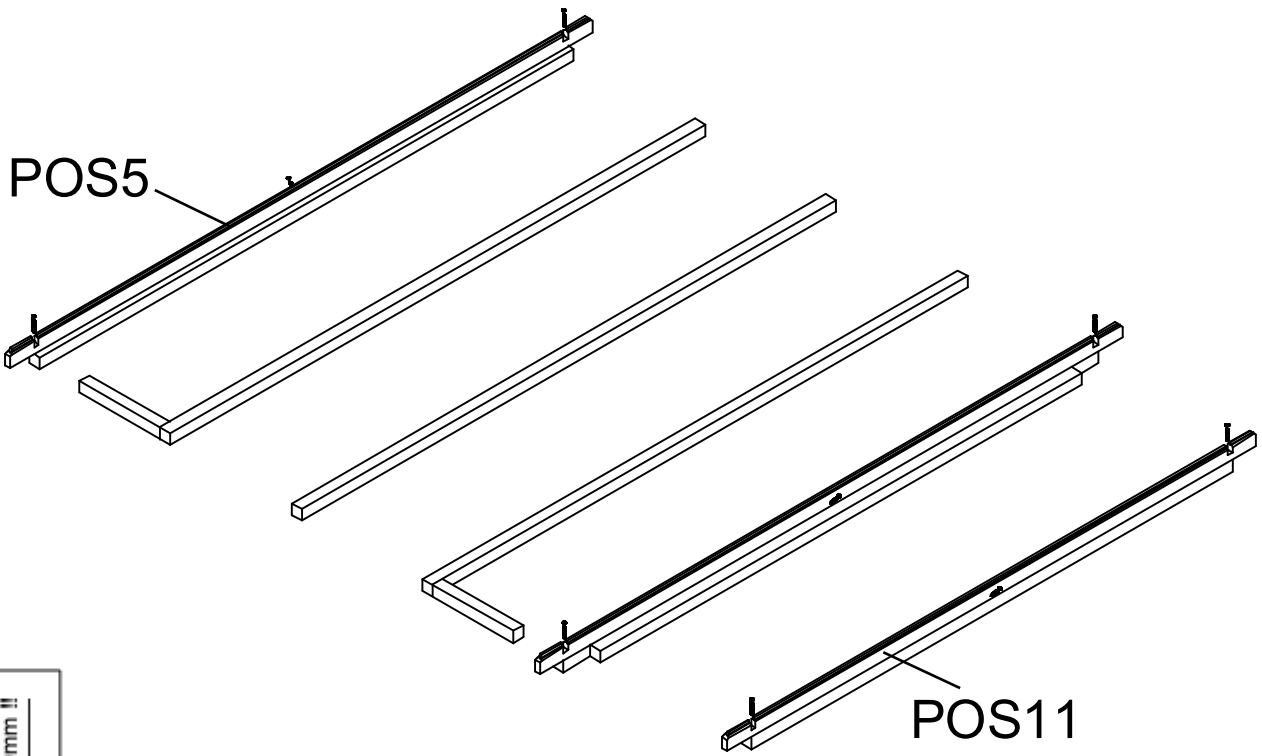
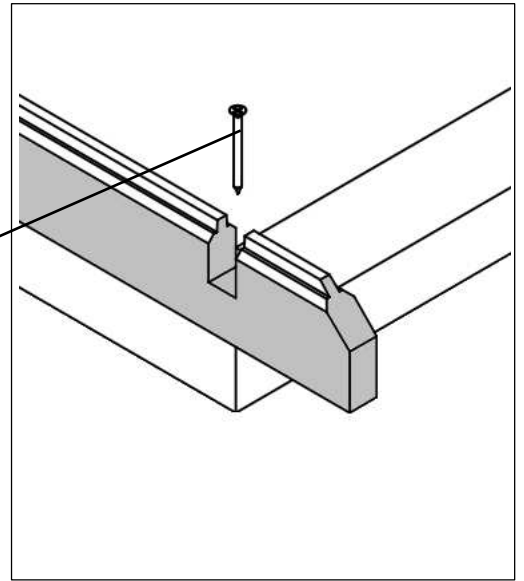

0mm !!

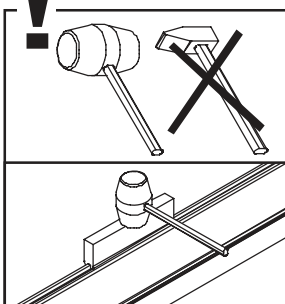

3

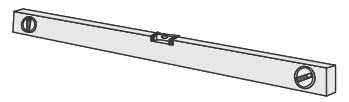
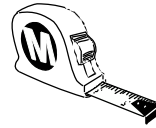
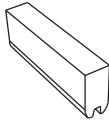
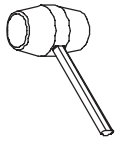

POS

6.  18X98X2180 3X

7.  18X98x414 2X



X2

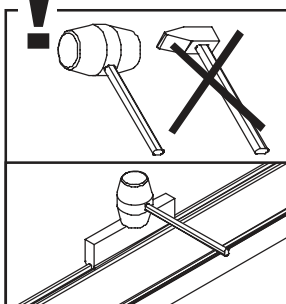
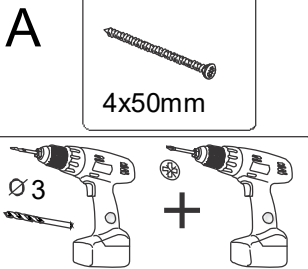
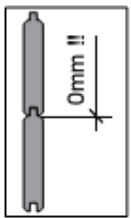
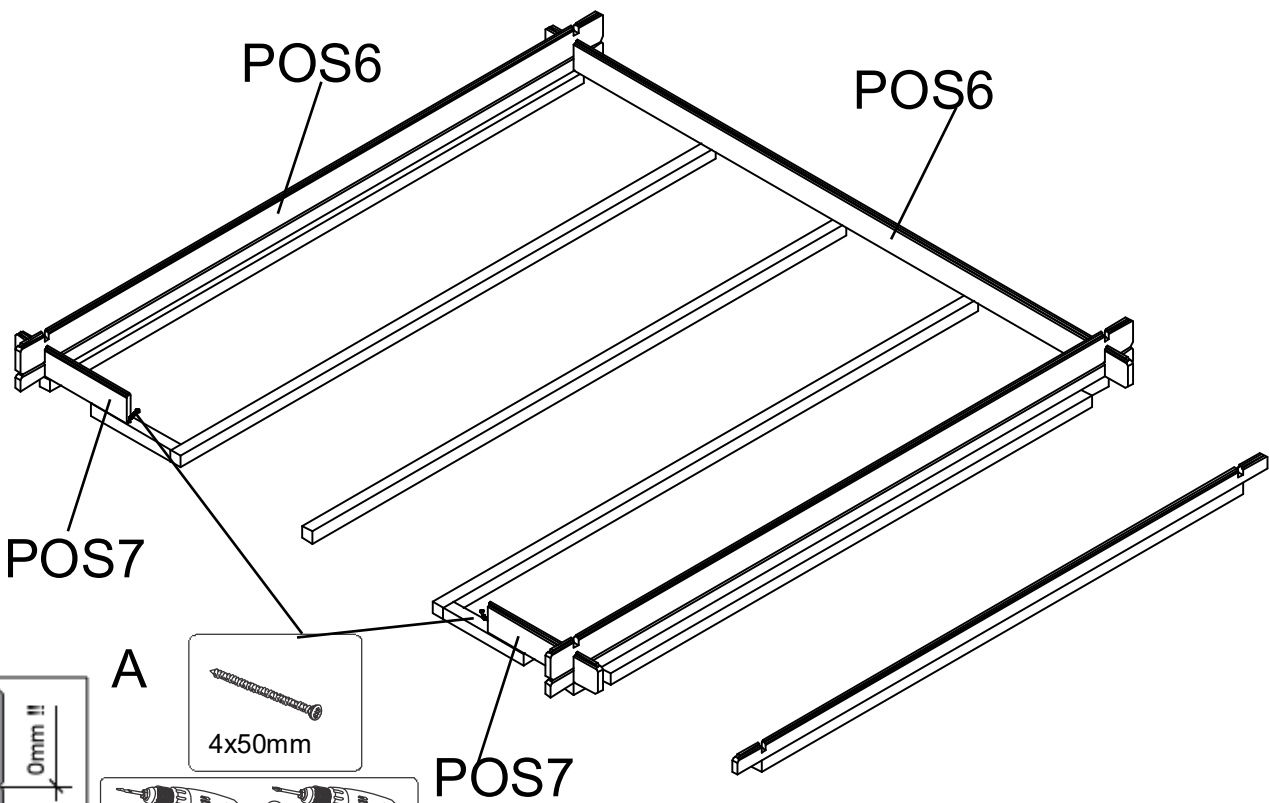

4

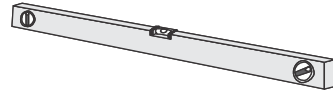
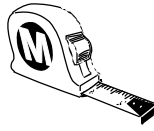
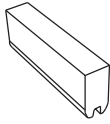
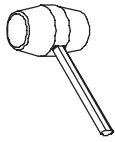

POS

6.  18X98X2180 56X

7.  18X98x414 36X

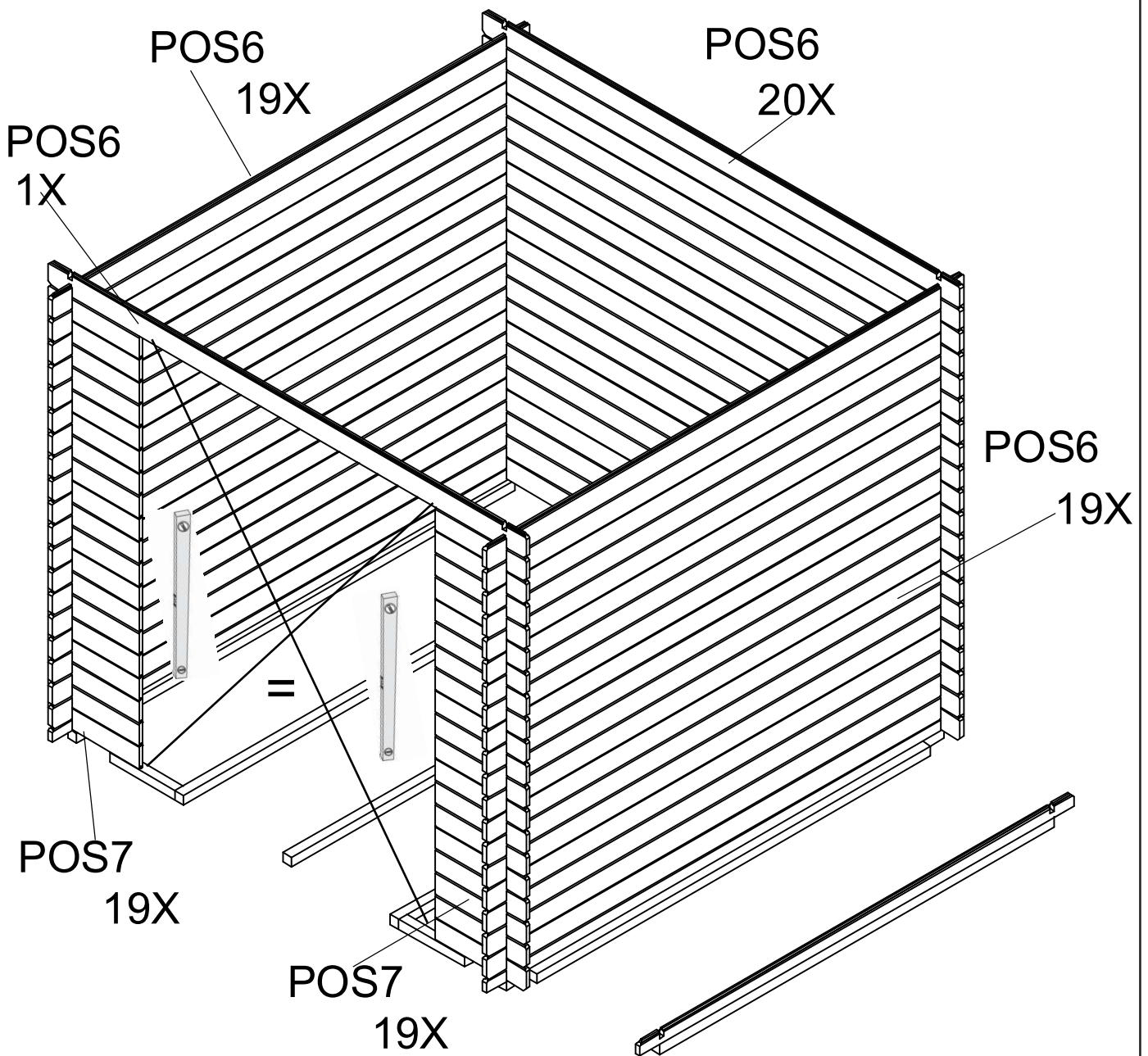
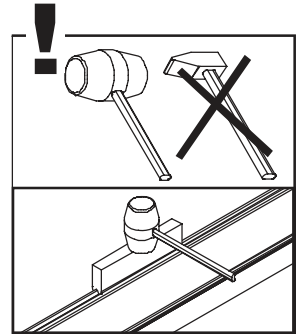
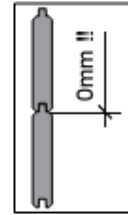

5

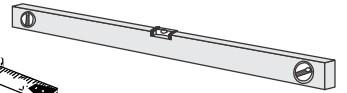
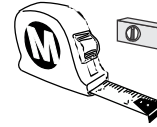
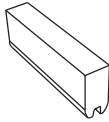
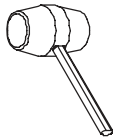

POS

6.  18X98X2180 2X

9.  18X245x2180 2X

 X4
4x50mm

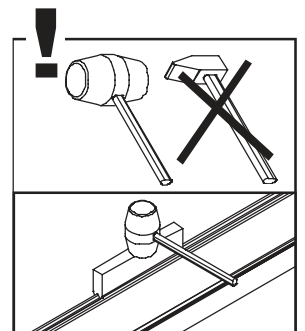
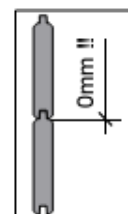
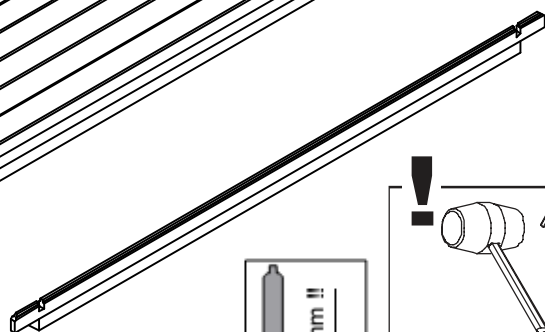
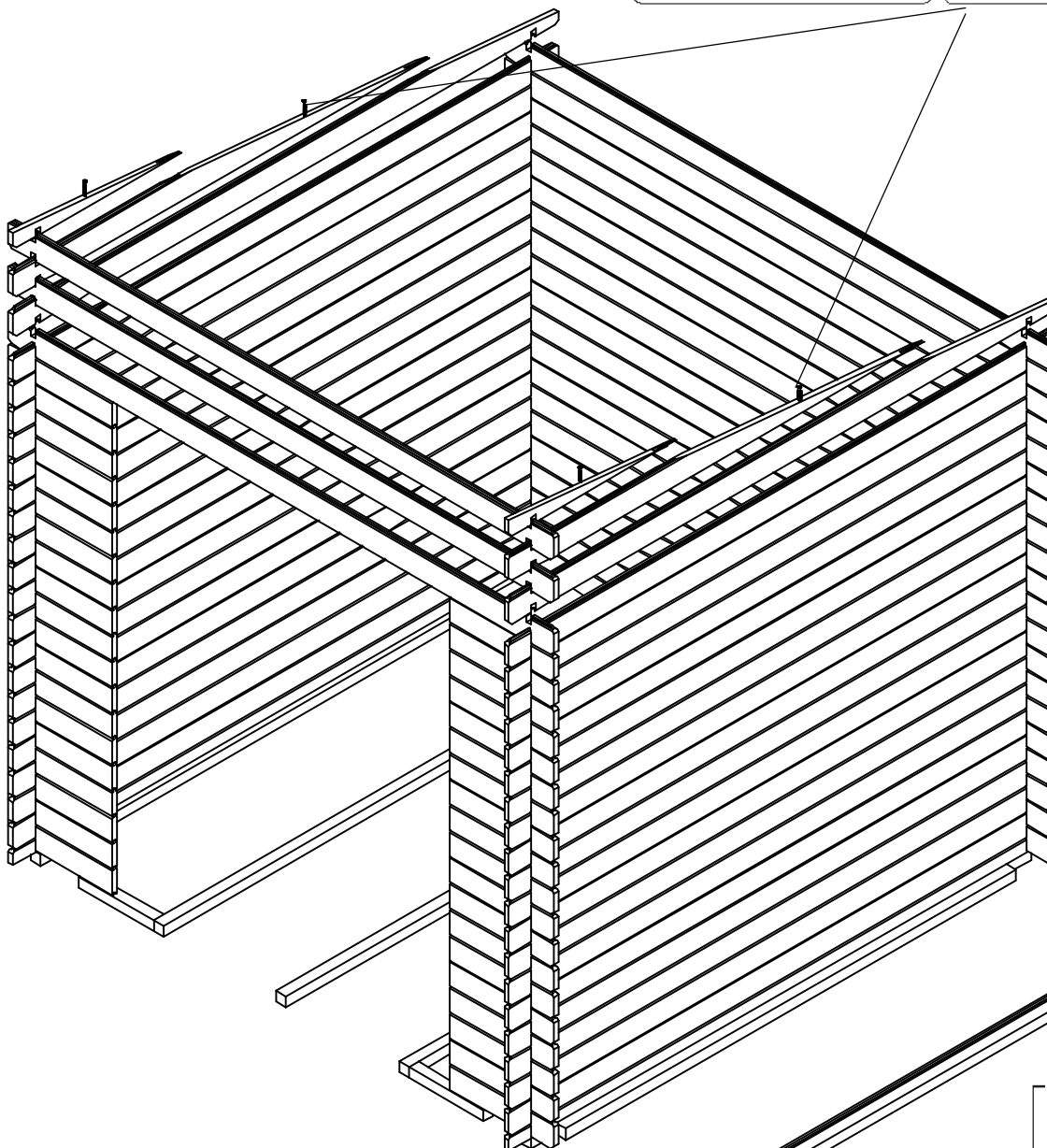
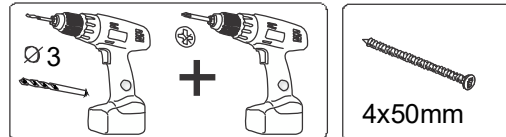

6

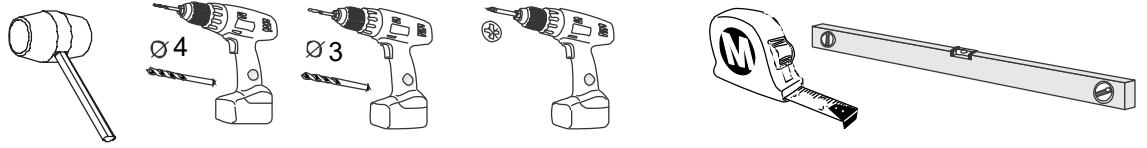

POS

18 

43X90X1962 2X

 8X

21 

20,6x27,6x150 4X

 8X

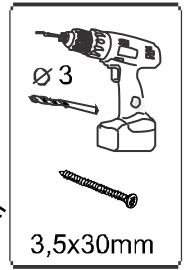
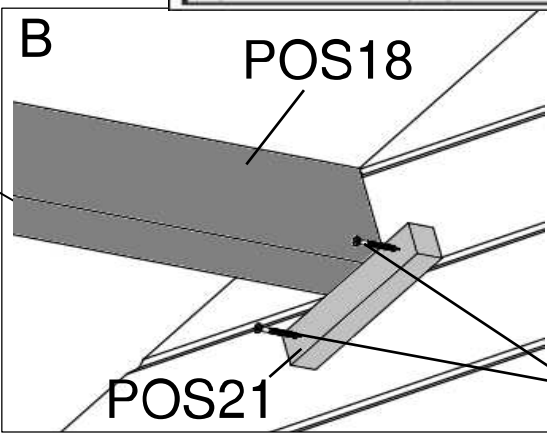
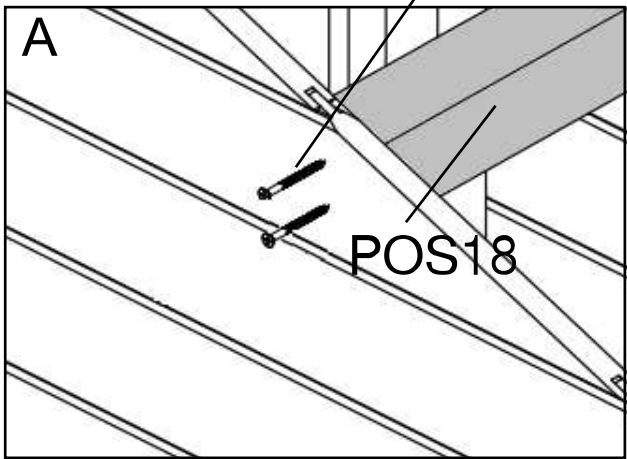
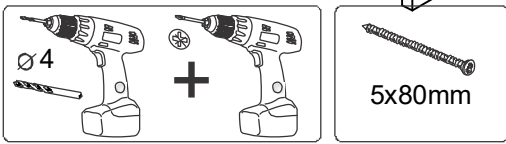
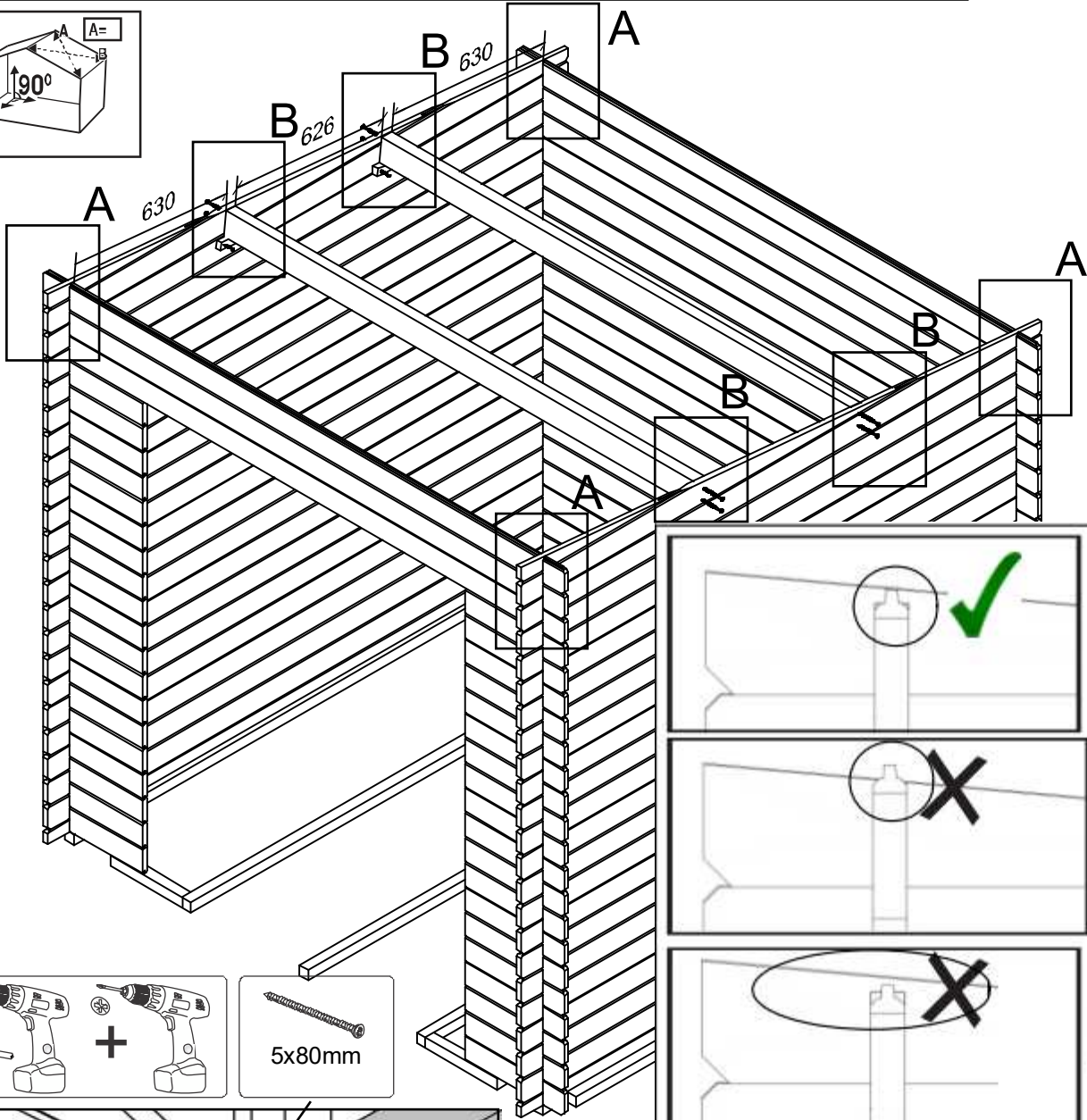
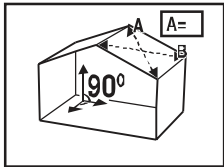

7

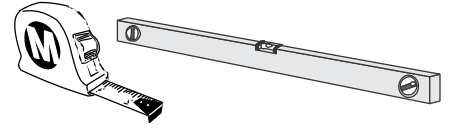

POS

17A  34x46x1795 2X



6X

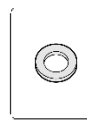

6X

17B  34x46x165 1X

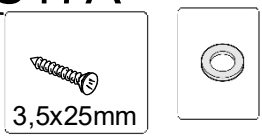
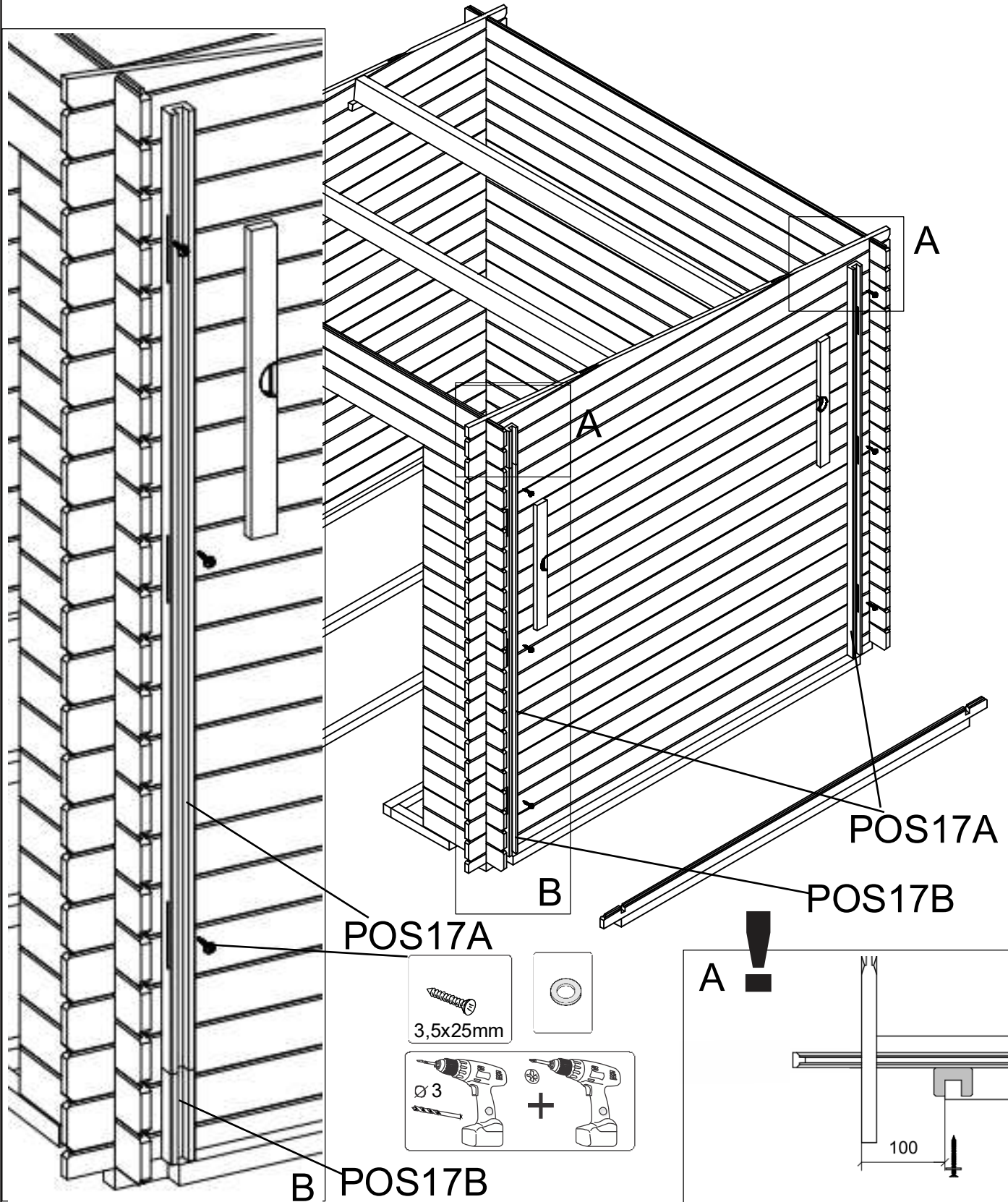

3,5x25mm

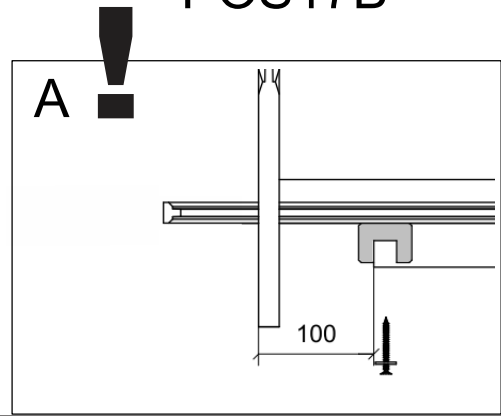
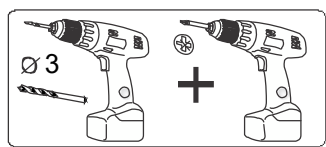

8

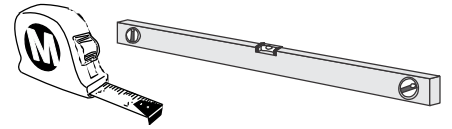
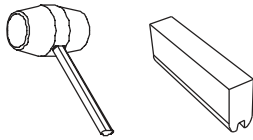

POS

| | | | |
|----|--|-----------|----|
| 12 | | 18X98X354 | 2X |
| 14 | | 18X98X675 | 2X |

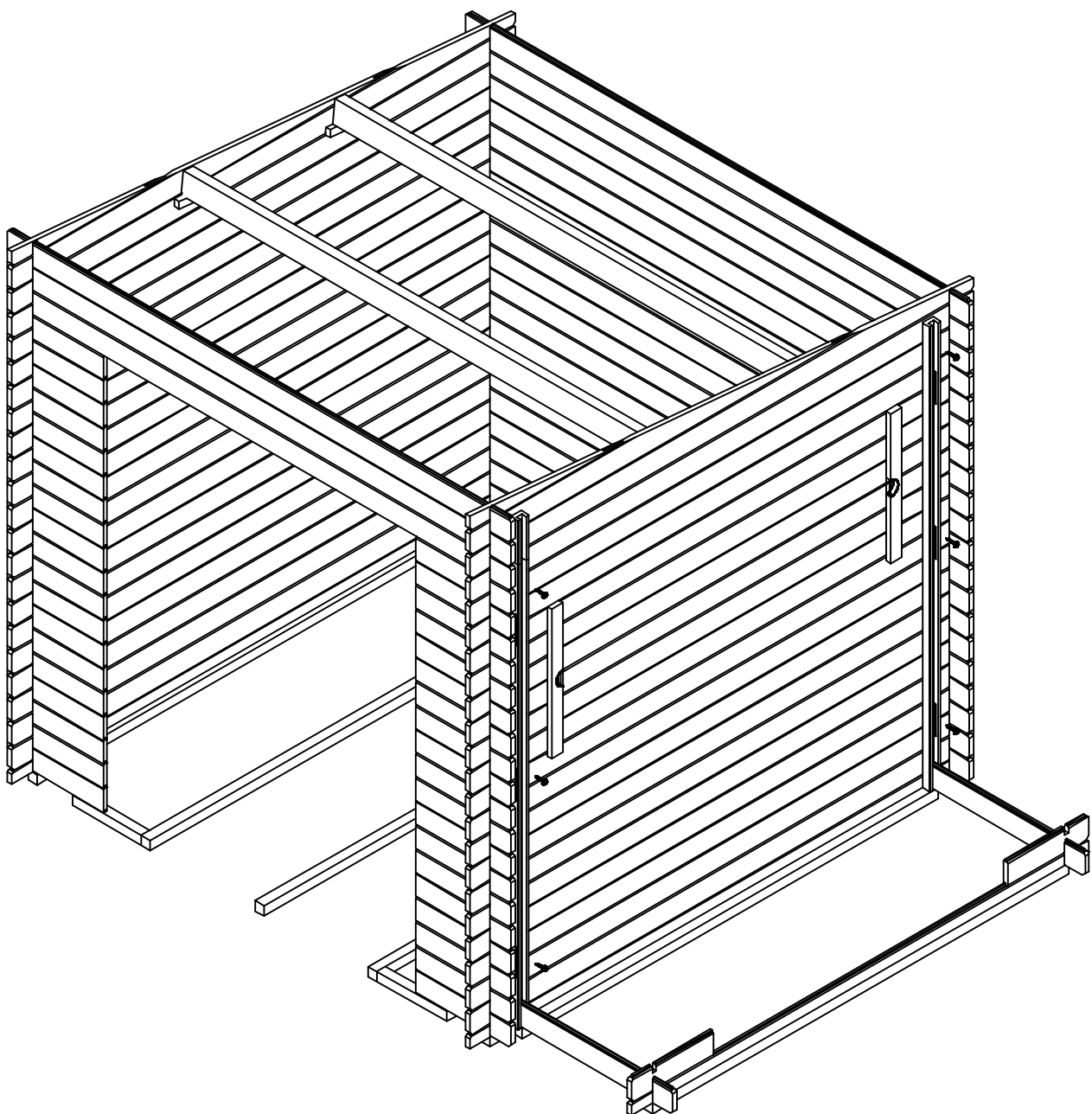
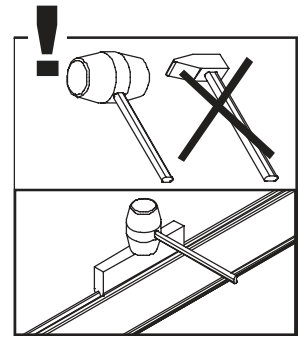
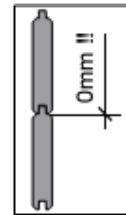

9

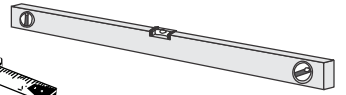
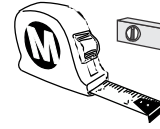
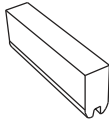
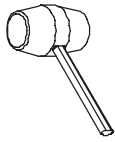

POS

13



18X98X1980 3X

12



18X98X354 30X

15



18x40x675 1X

14



18X98X675 39X

16



18x89x675 1X

10

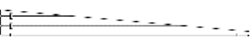

18x240x1980 1X

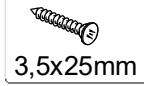

6X

3,5x25mm



6X

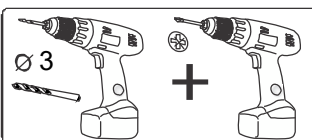
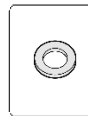
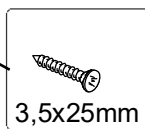
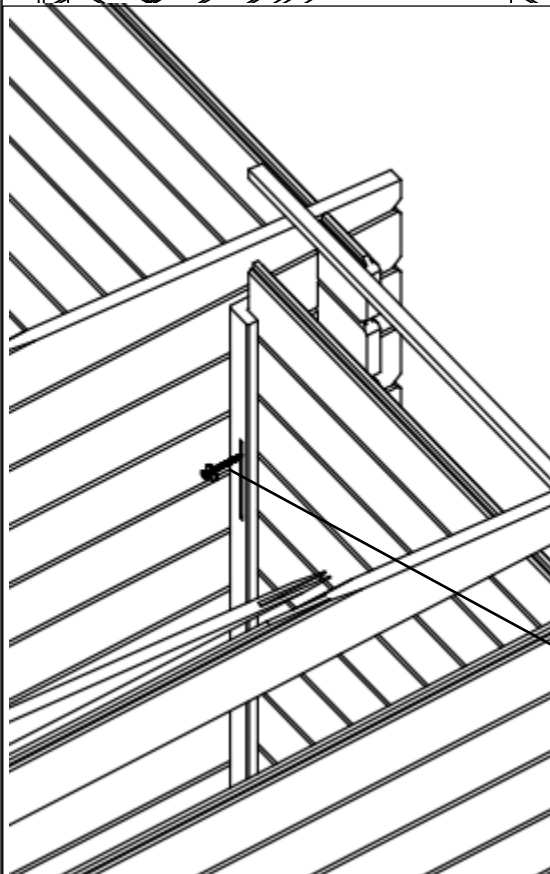
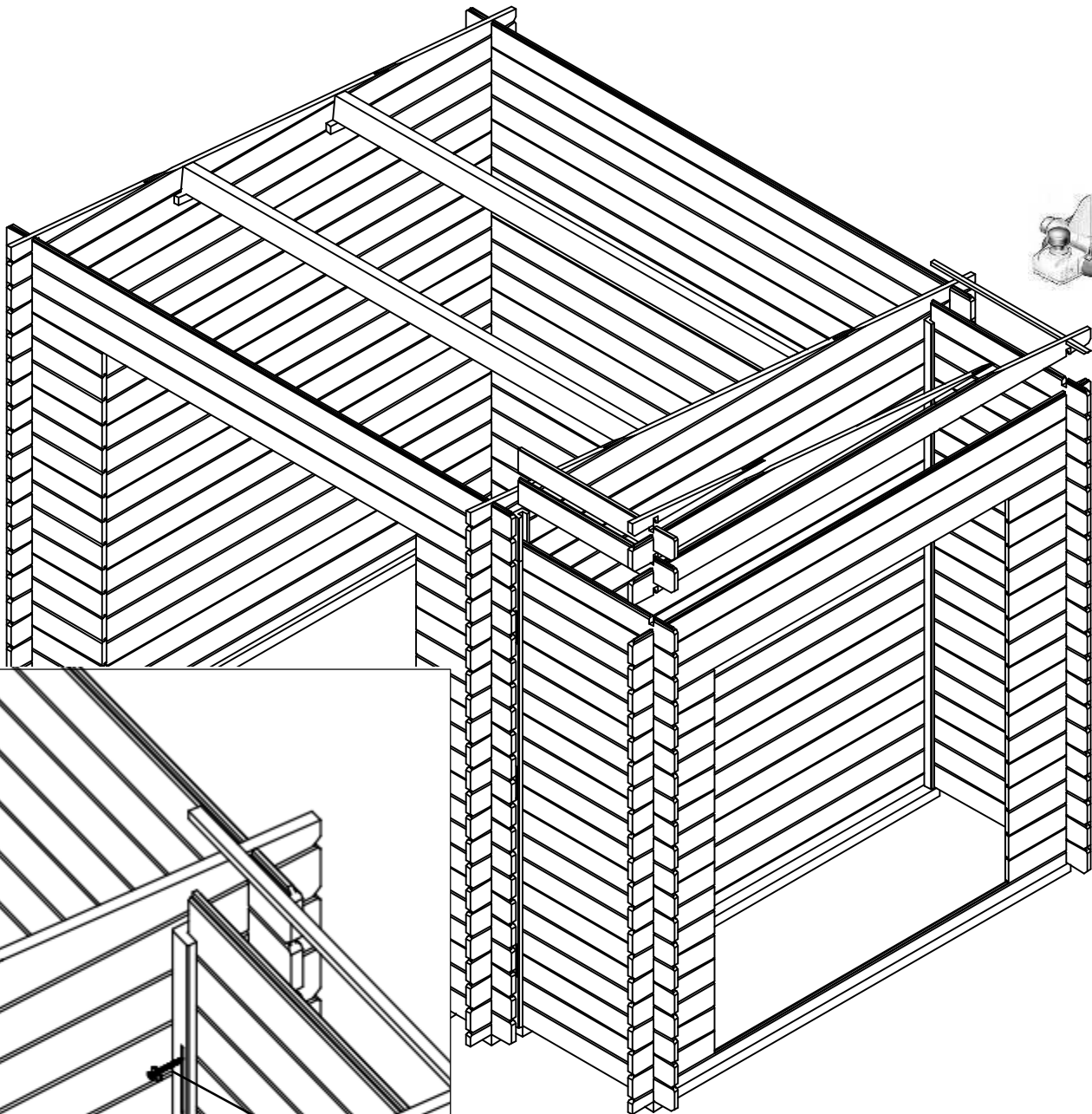

10

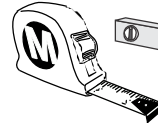
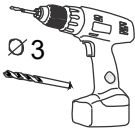

POS

19

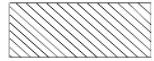

43x90x580 1X



X2



4X

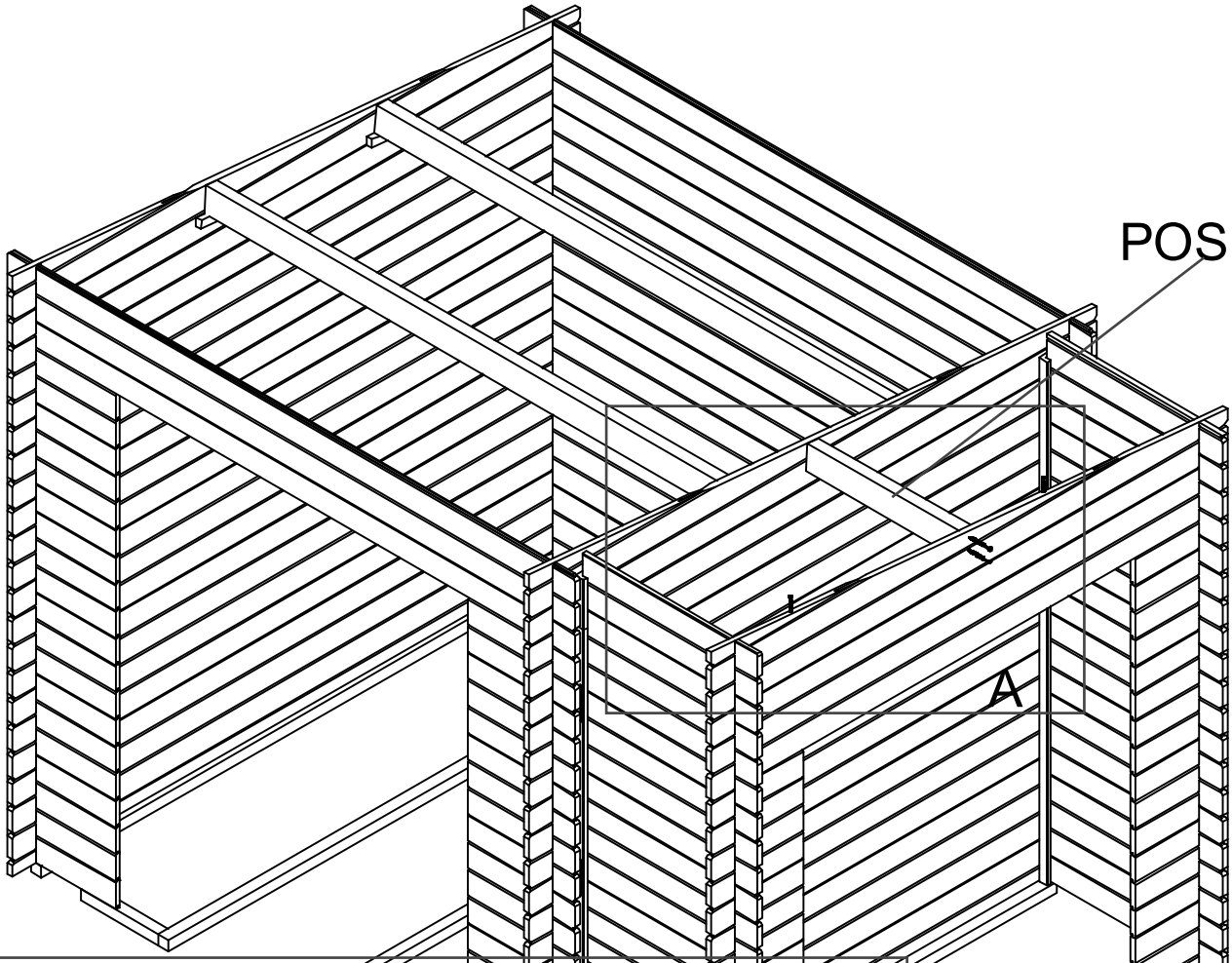

POS19

A

POS19



5x80mm

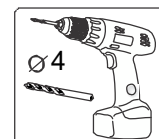

Ø4

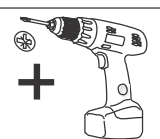

+



Ø3

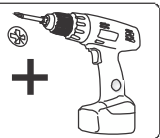

+



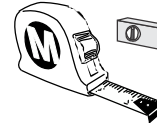

4x50mm

11



POS

26  42x68x1720 2X

27A  20,6x40x1250 1X

27B  12x26x1250 1X

36  42x68x1500 2X

37  12x26x1172 1X

 6X
3,5x25mm

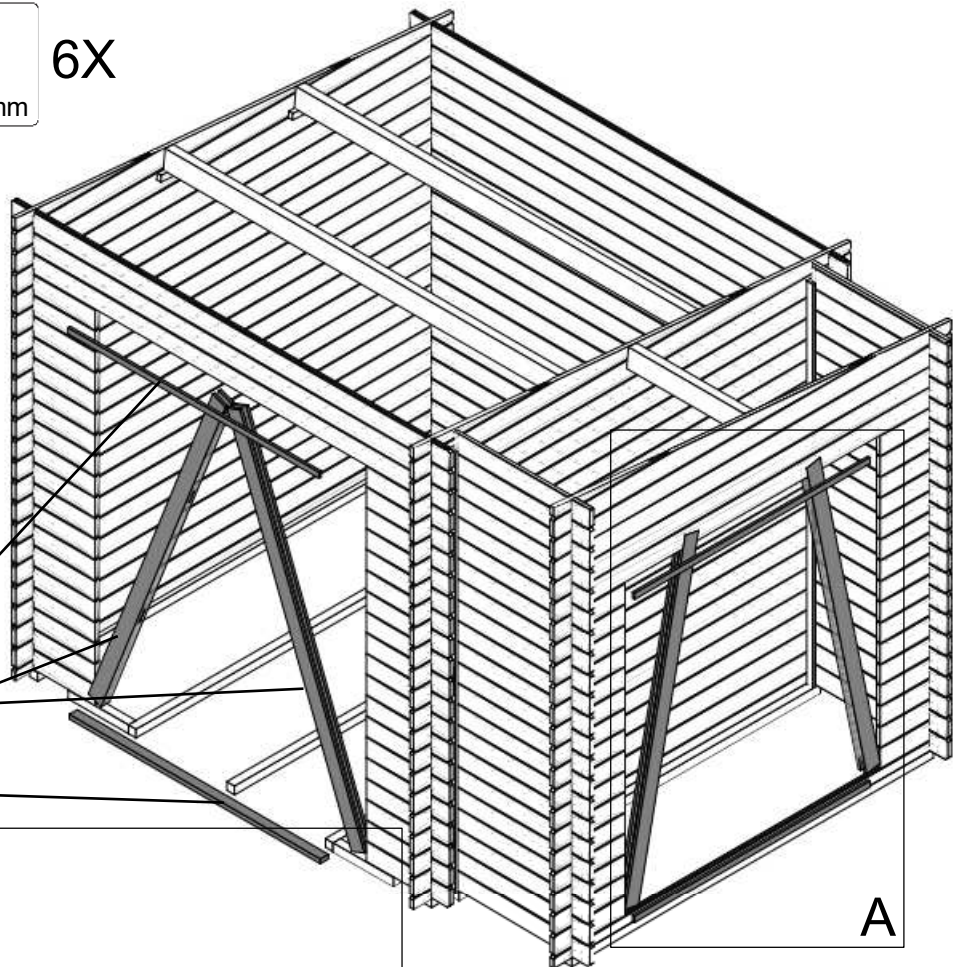

POS27B
POS26
POS27A

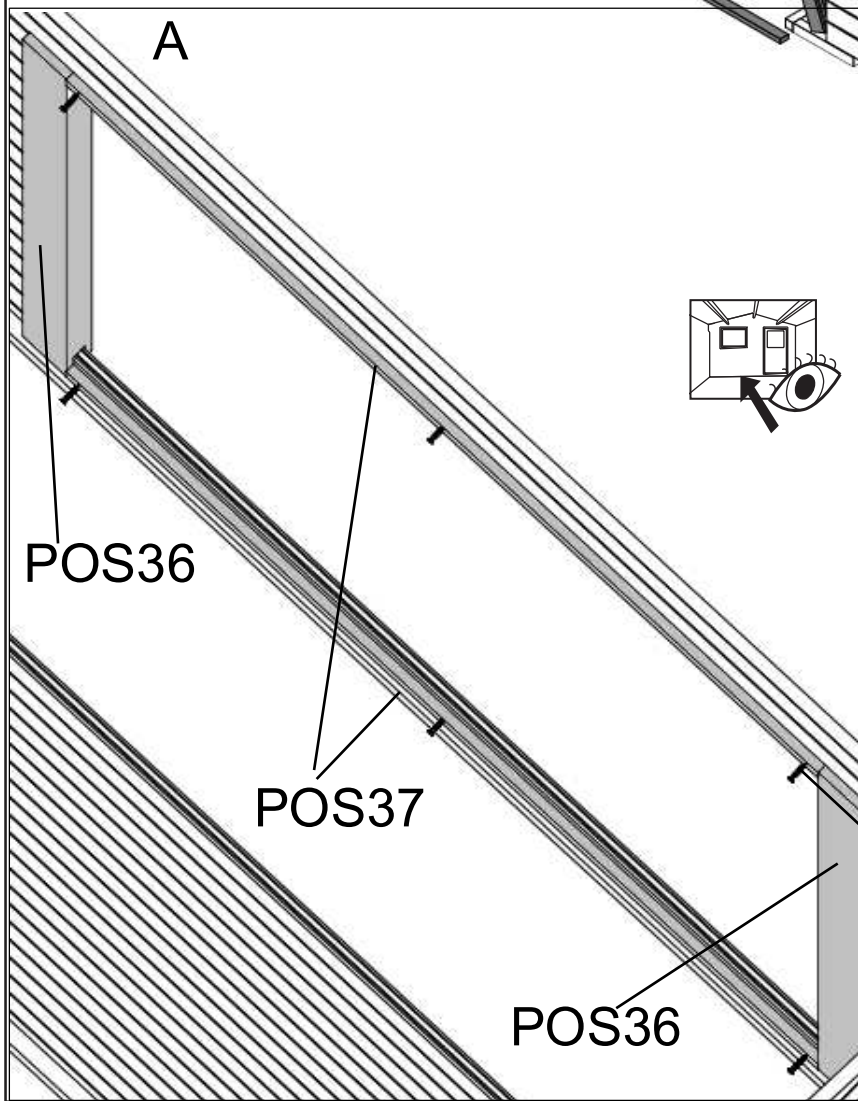

POS36

POS37

POS36

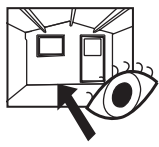

 3,5x25mm

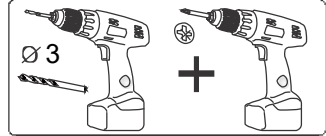

12

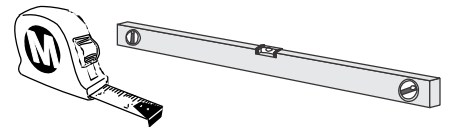

4X

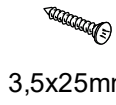

6X

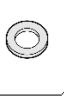

6X

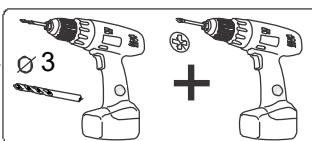
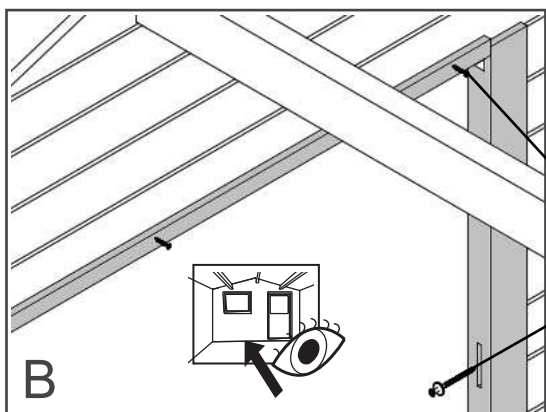
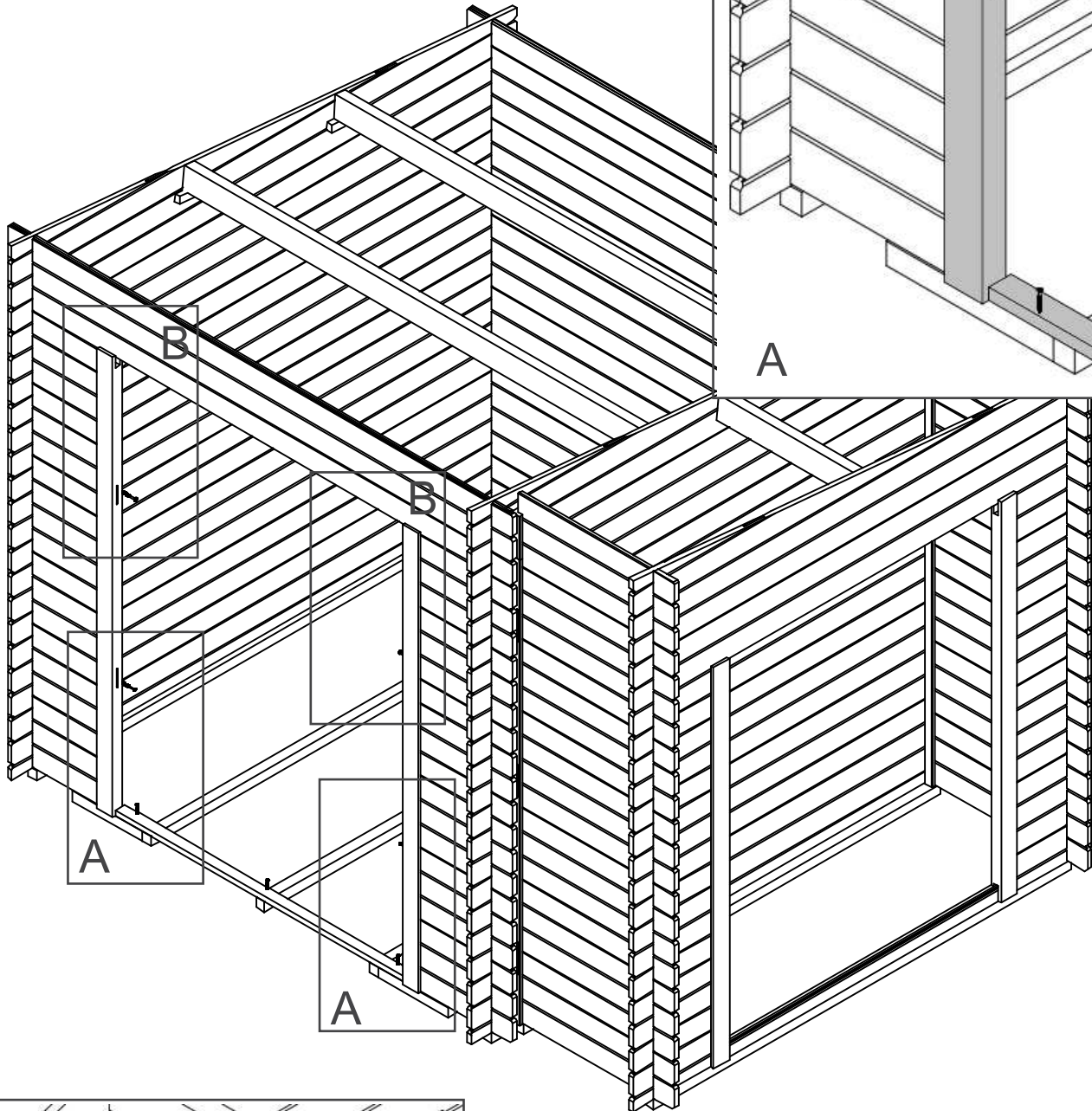
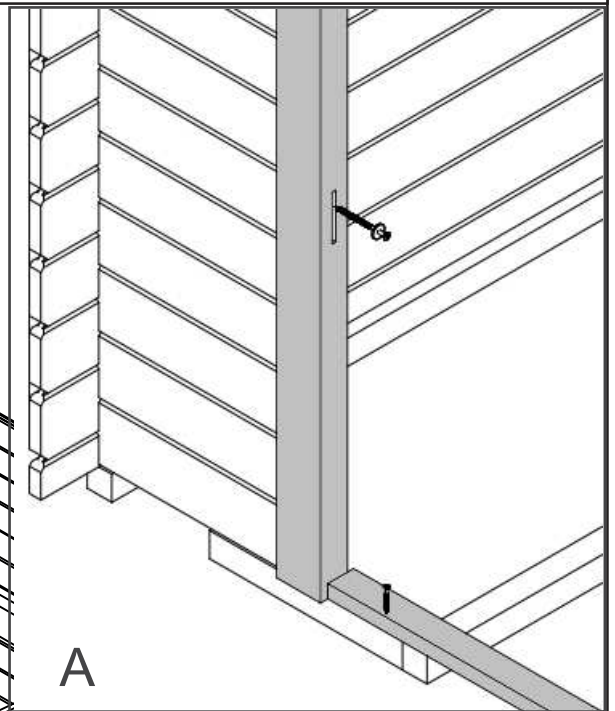

+

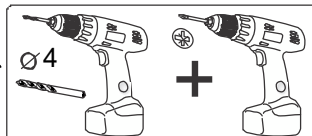

+



+

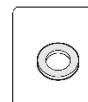

13

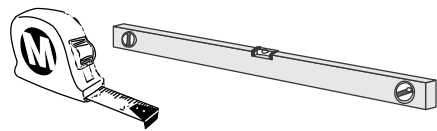
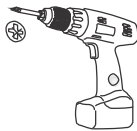

POS

40  34x46x1633 3X

41  15x95x1950 2X

 12x
3,5x30mm

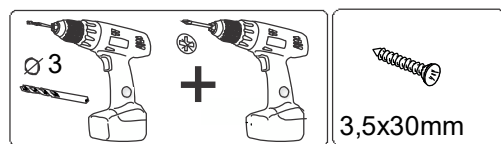
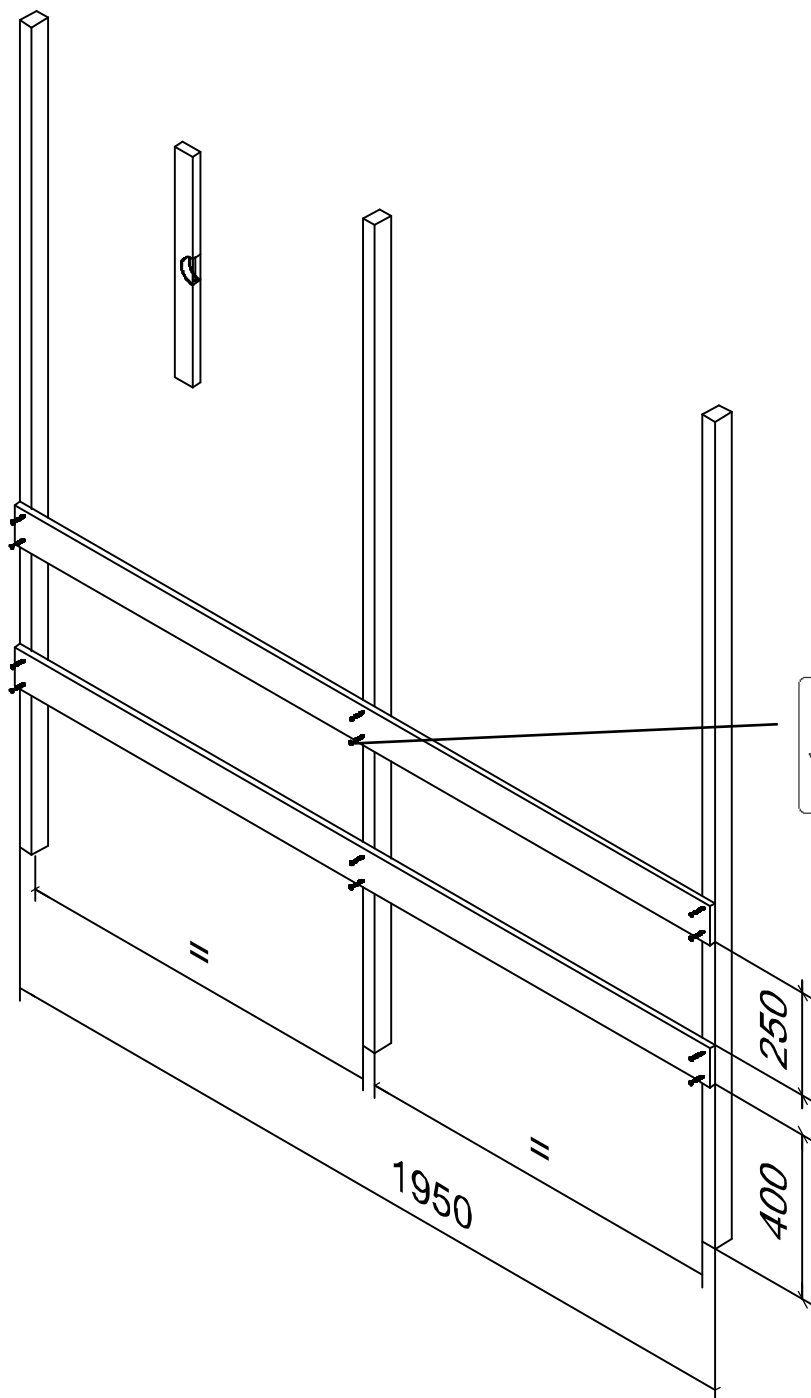

14

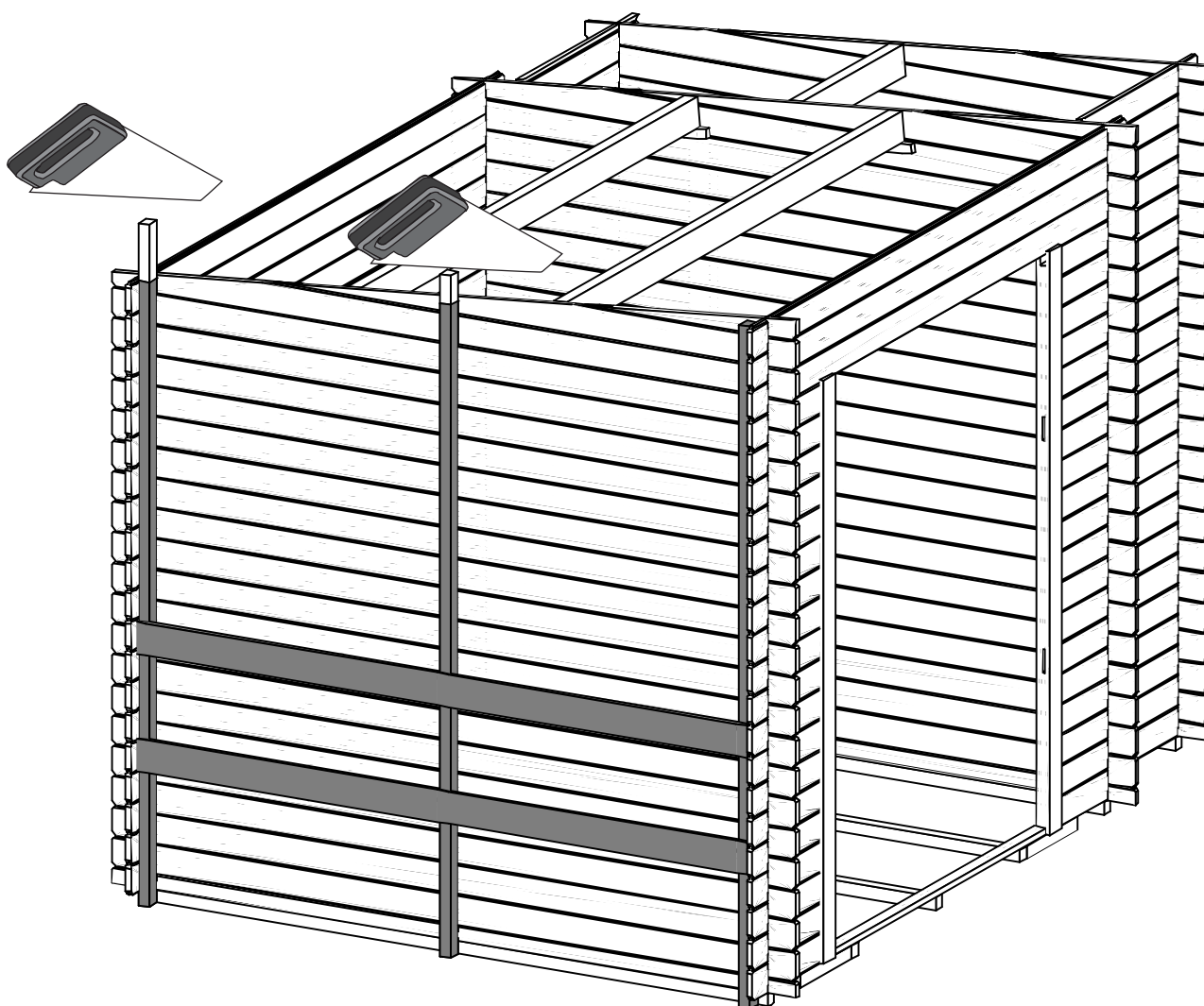
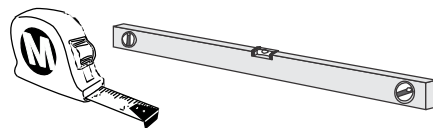
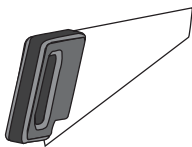

15

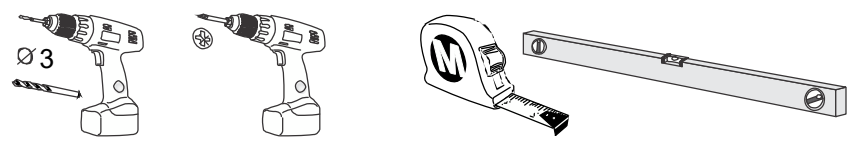

POS

20



43x90x628 3X

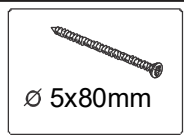

12X

Ø 5x80mm

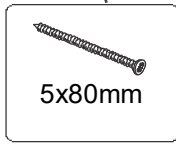
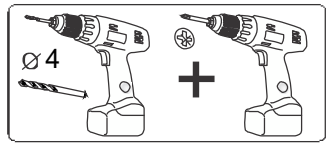
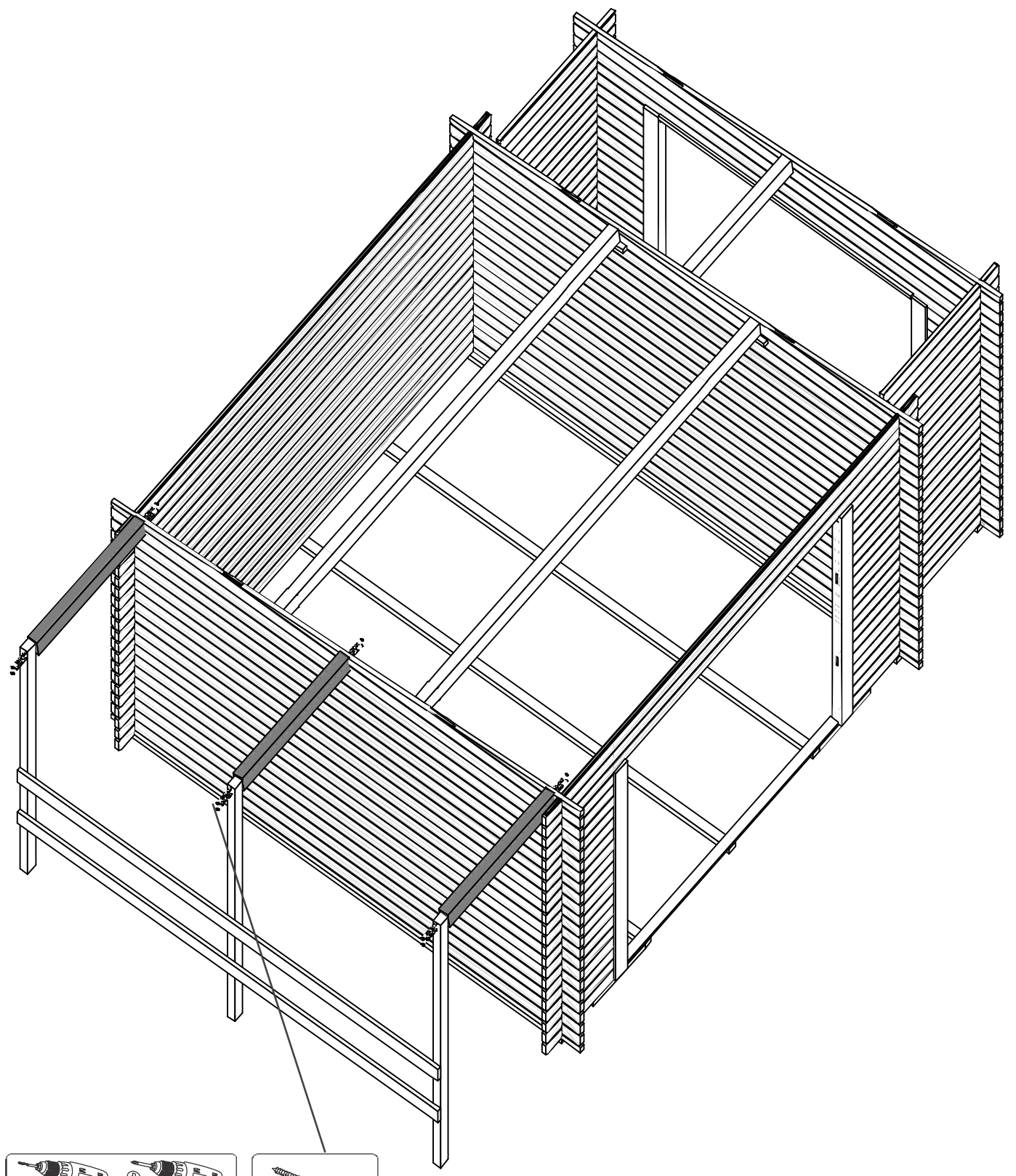

16

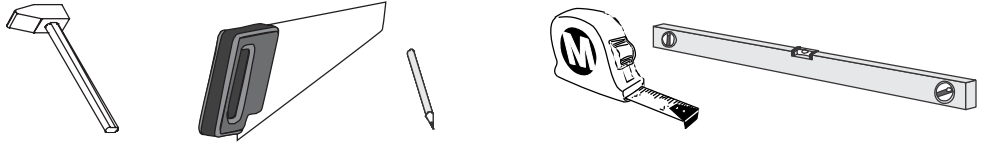

POS

22  15x99x2350 38X

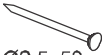
 180X
Ø2,5x50

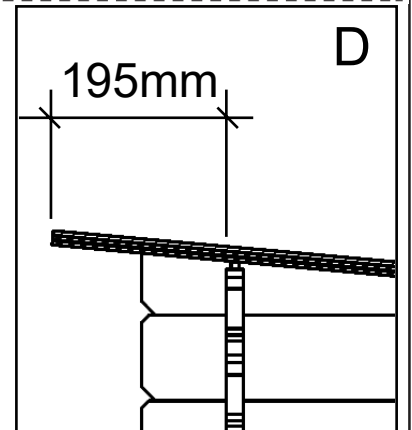
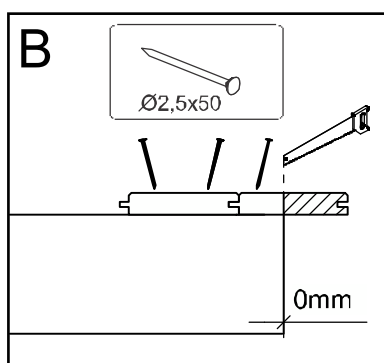
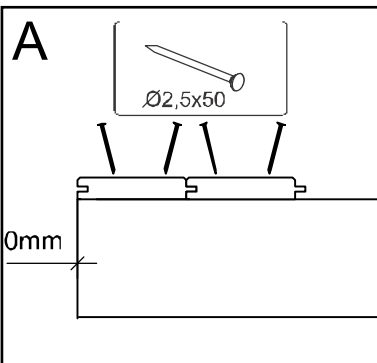
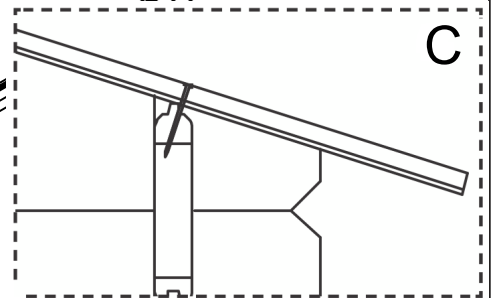
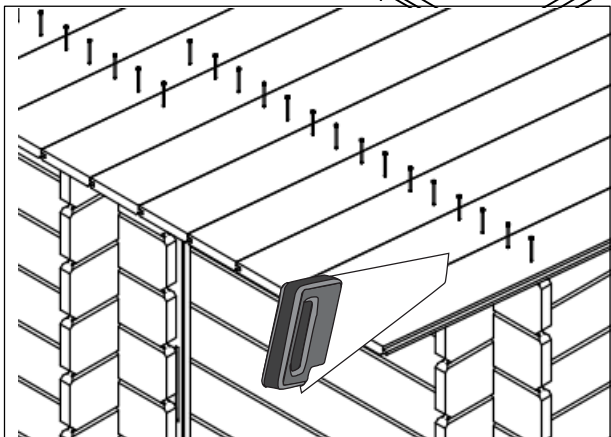
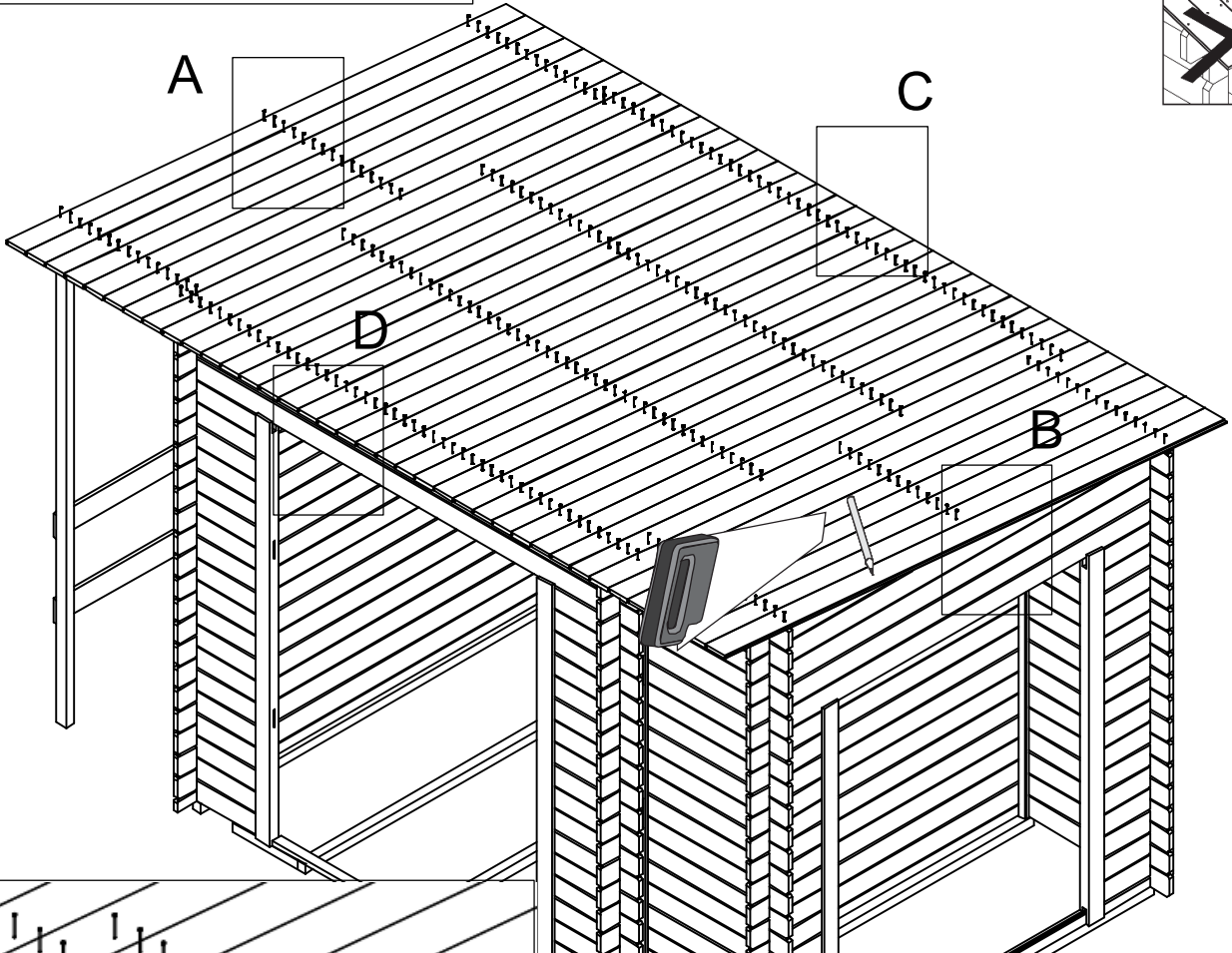
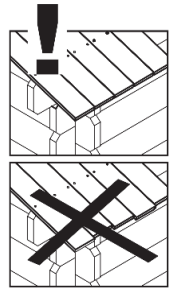
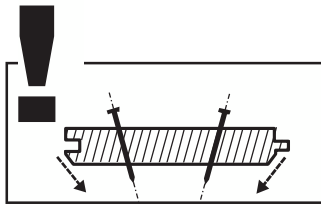

17

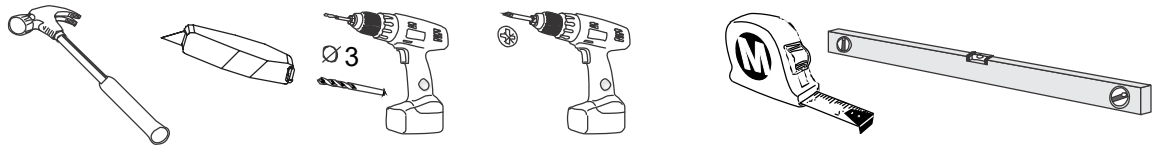

POS

- 25. 12x26x1680 2X
- 43 1,0x12m 1X
- 140X \varnothing 2x16
- 3,5x25mm 6X

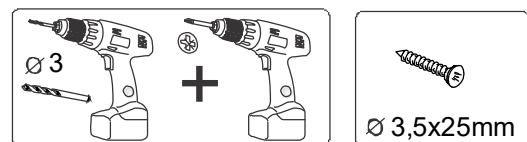
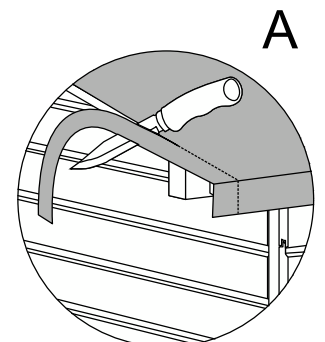
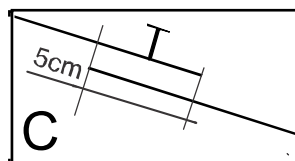
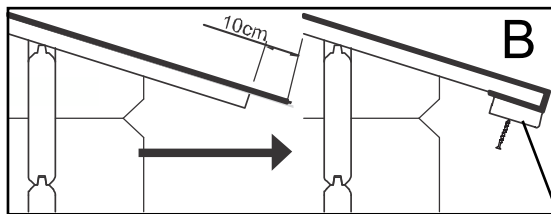
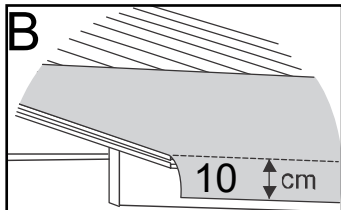
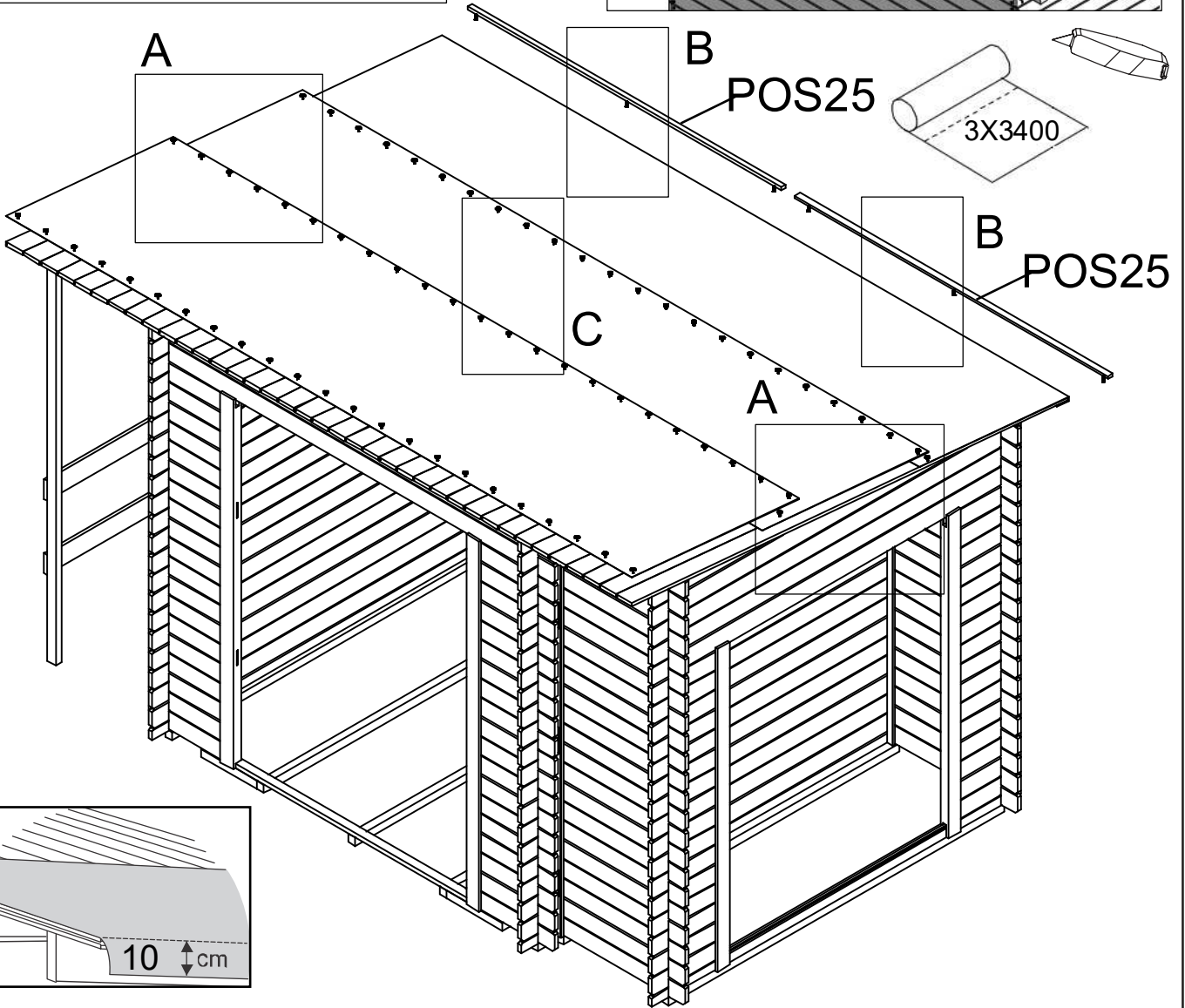
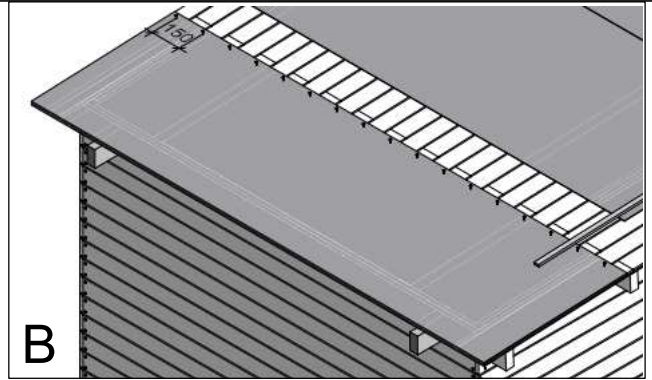

POS25

18

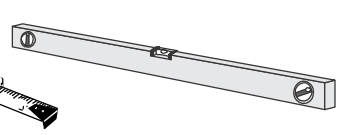
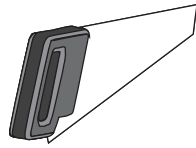

POS

41



15x95x1950 1X

23A



15x95x1260 4X

24.



12x42x1820 5X

23B



15x95x1410 1X

27C



18x40x581 3X



24X

3,5x30mm

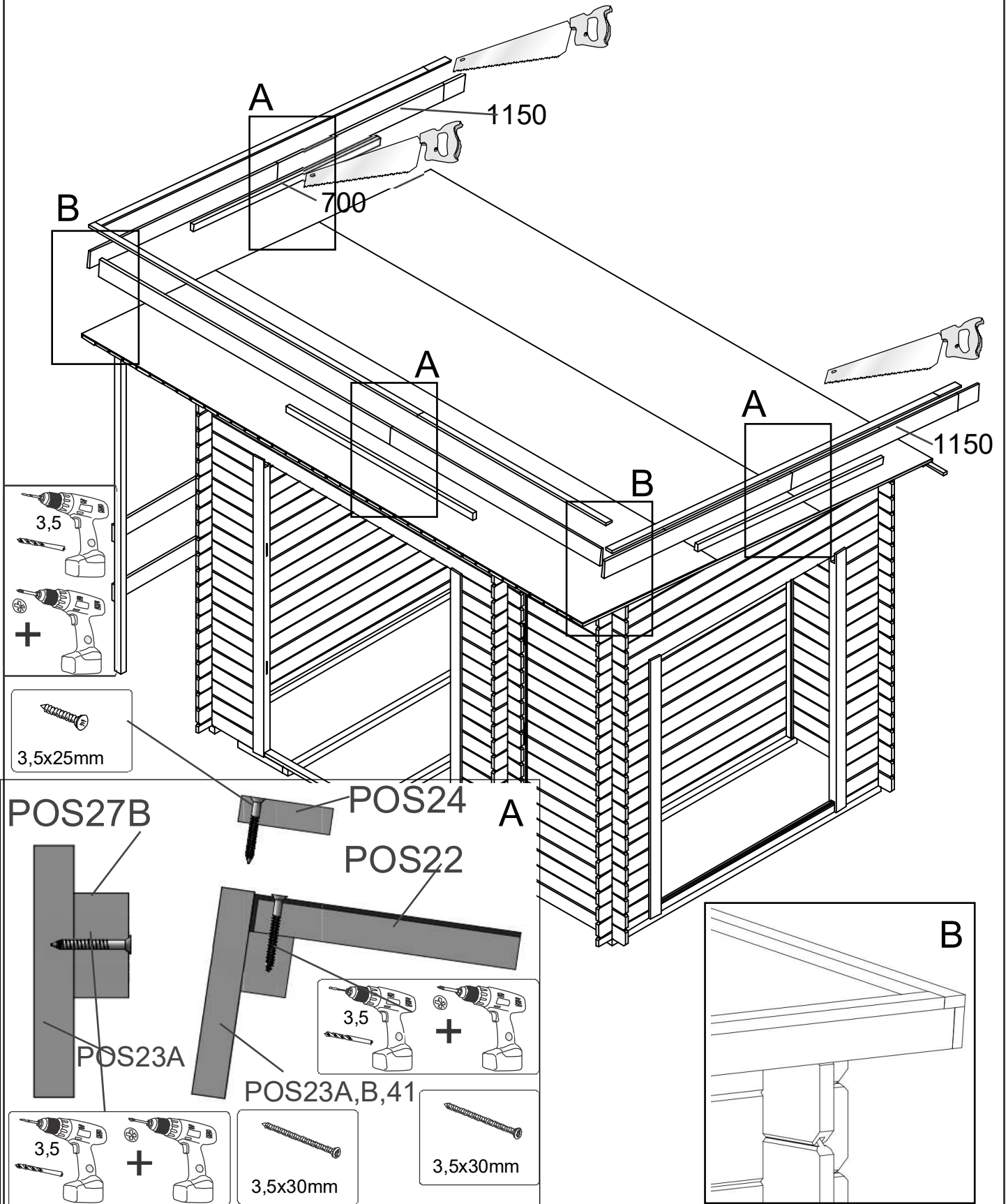

19

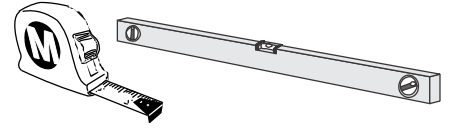

4X

3,5x30mm



16X

3,5x25mm

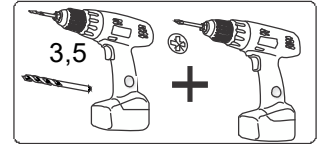

+

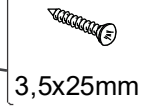

3,5x25mm

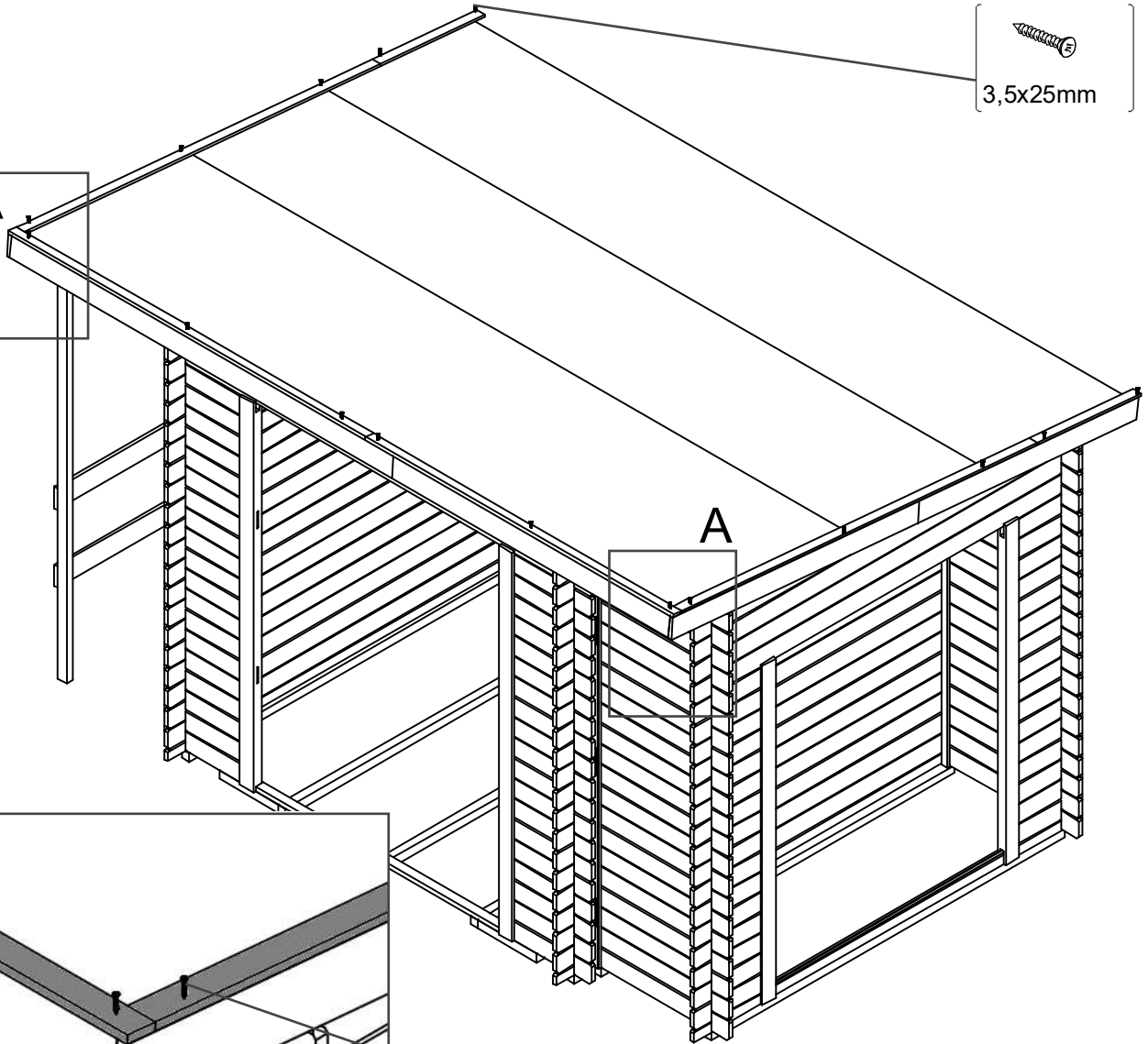
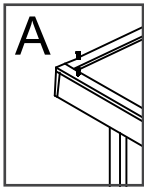

A

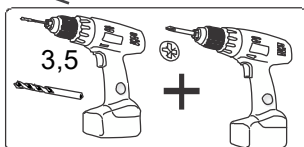
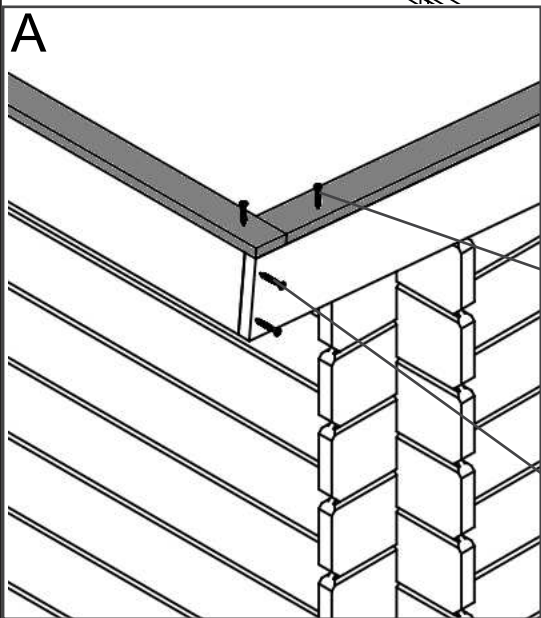

+

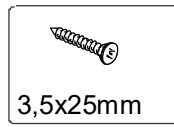

3,5x25mm

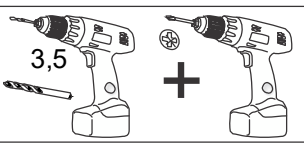

+

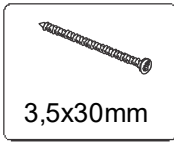

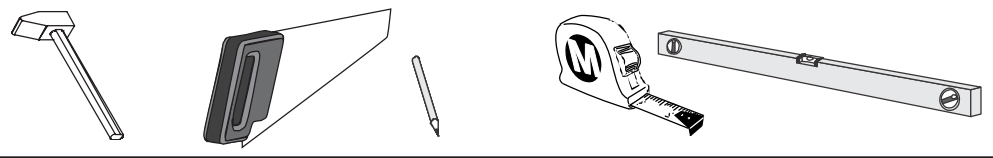

3,5x30mm

20



POS

3  15x99x1962 22X

4  15x99x576 20X

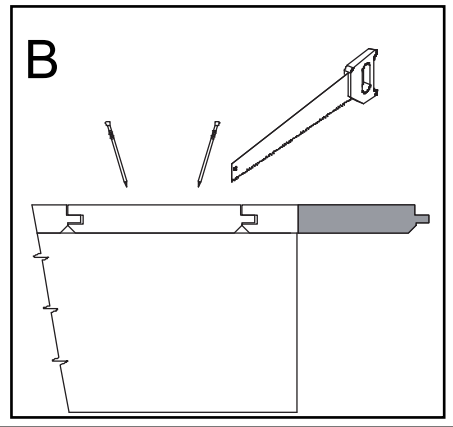
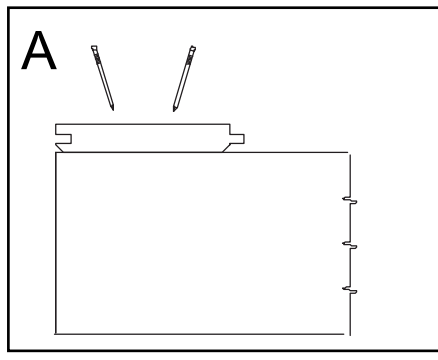
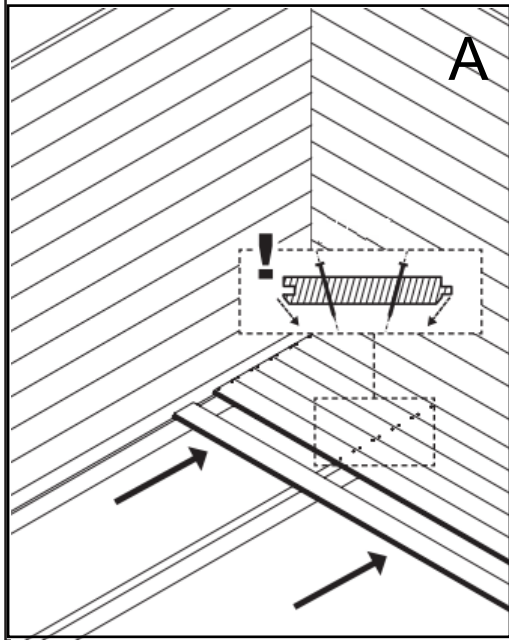
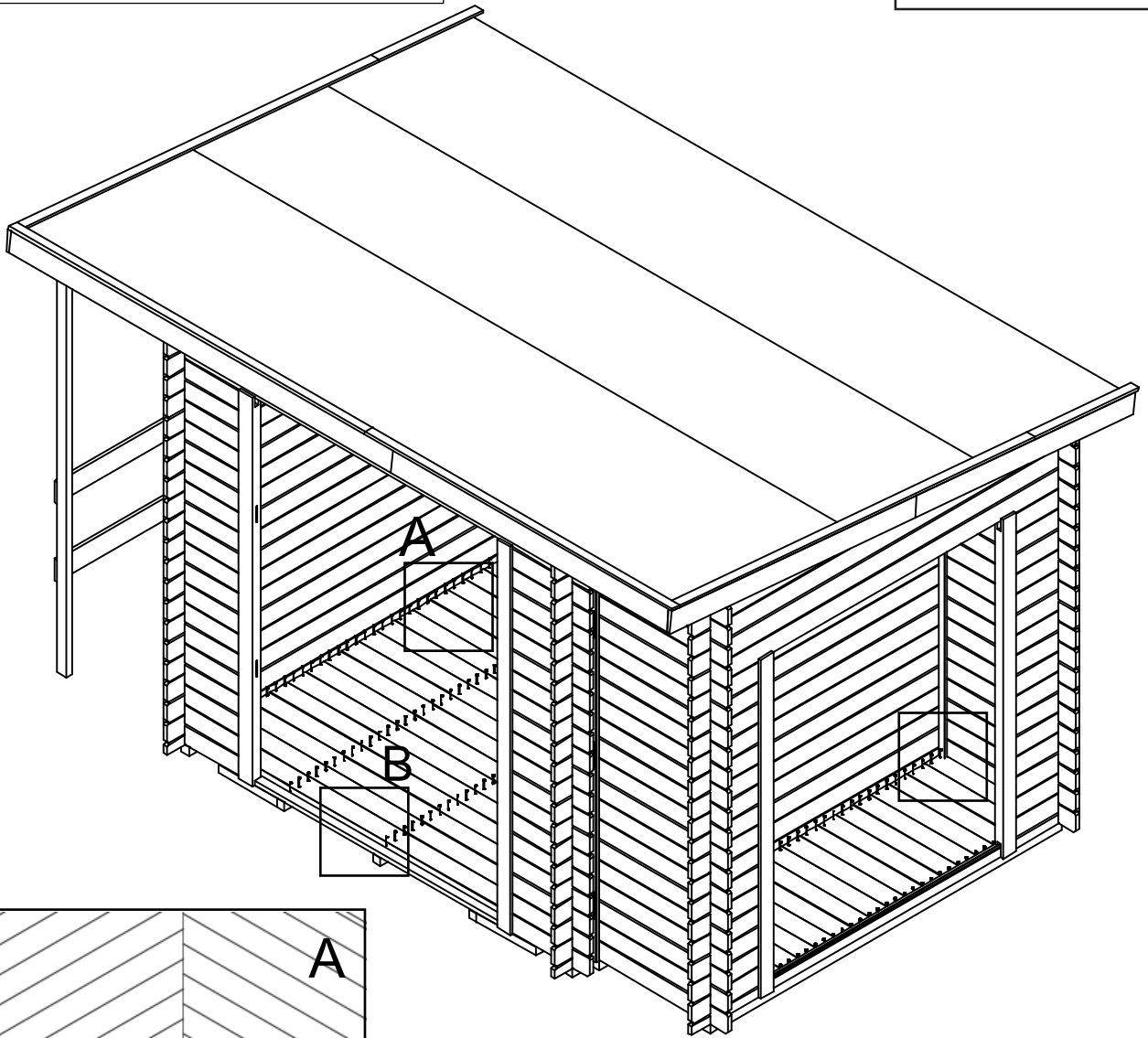
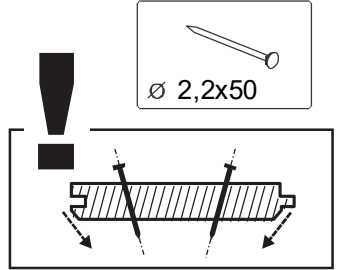
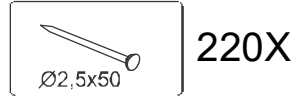

21

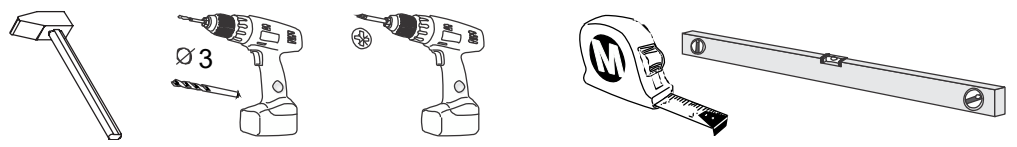

| | | | | | | |
|------------|-----------|-----------|---------------|-----------|--|----------------|
| POS | 32 | | 18X38X485 4X | 39 | | 581x1500 zü 1X |
| 28. | | 33 | 15X25X673 2X | | | |
| 29. | | 34 | 15X25X445 2X | | | |
| 30 | | 35 | 12X42X1740 2X | | | 34x |
| 31 | | 38 | 581x1500 z 1X | | | 8x |
| | | | | | | Ø 7x1,6x30mm |

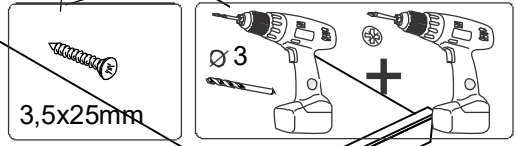
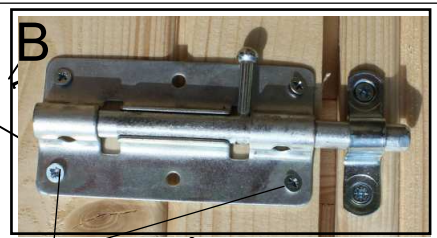
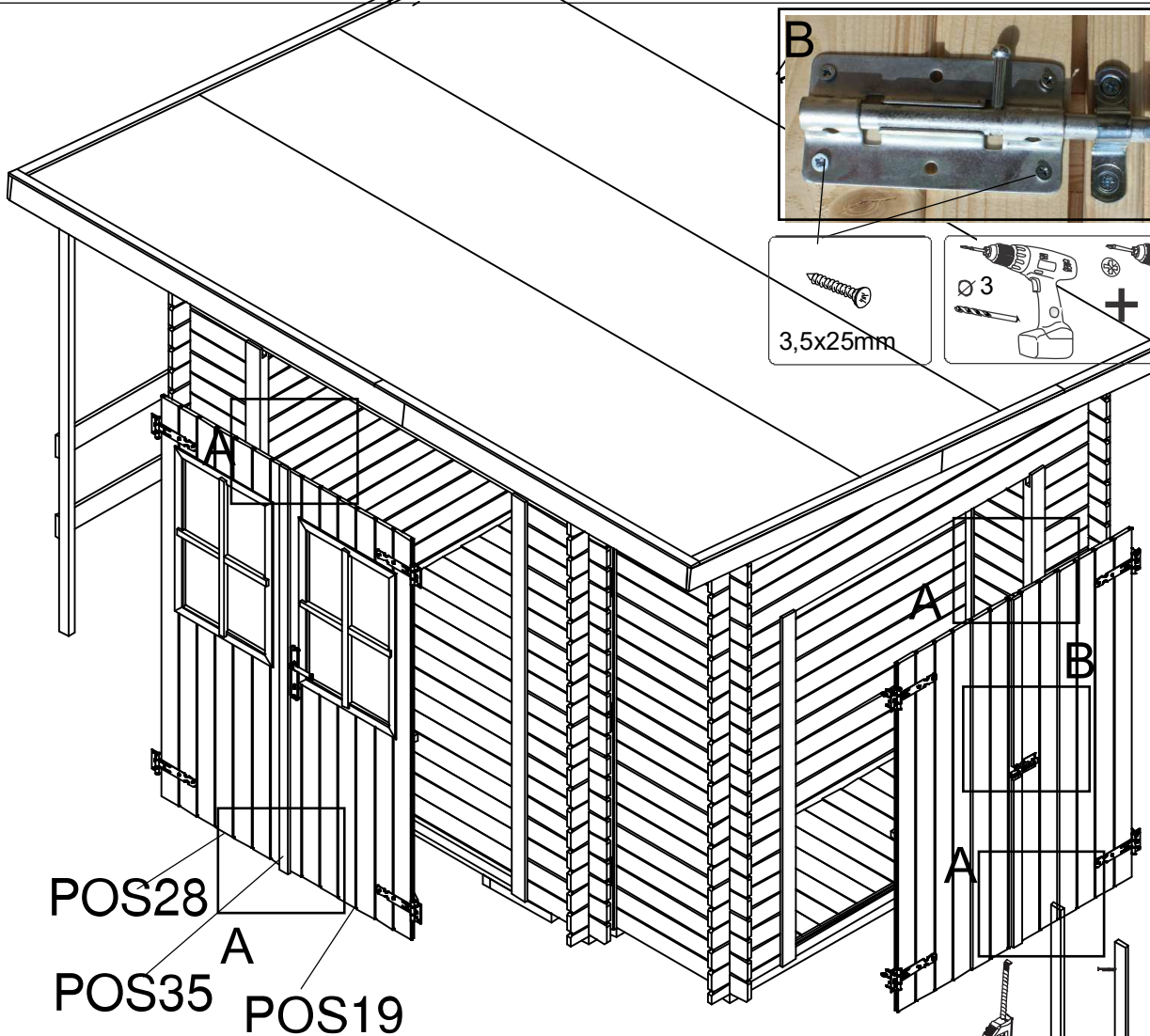

POS28
A
POS35
POS19

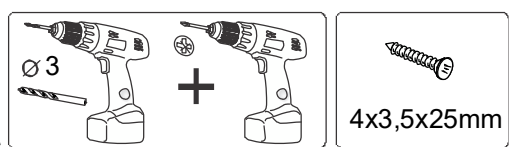

POS35

22

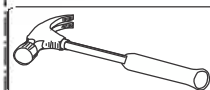
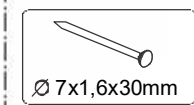
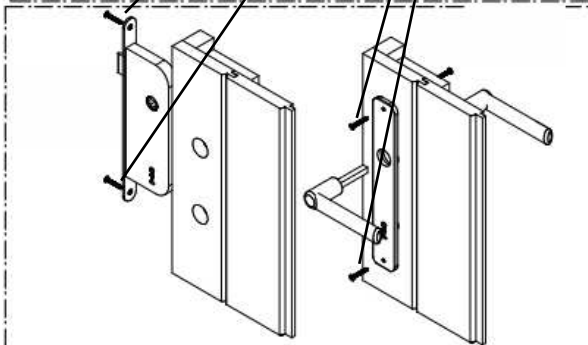
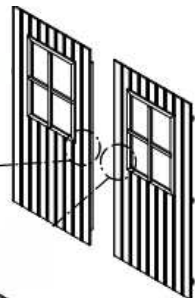
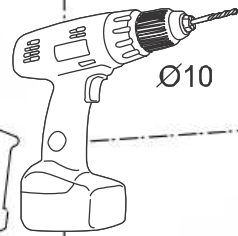
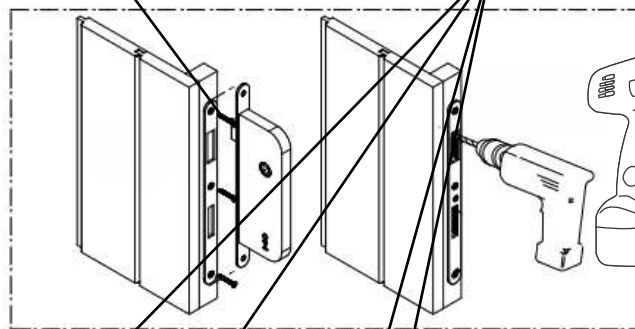
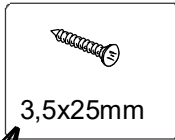
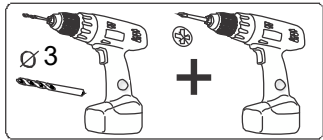
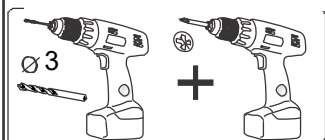
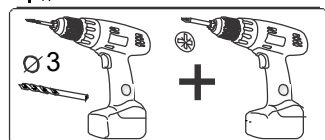
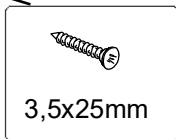
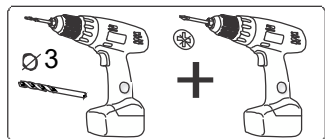
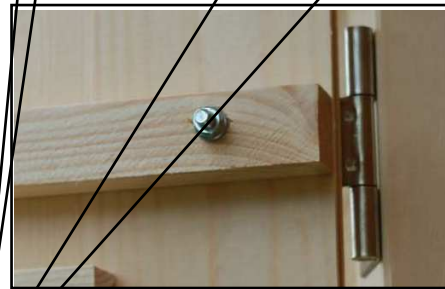
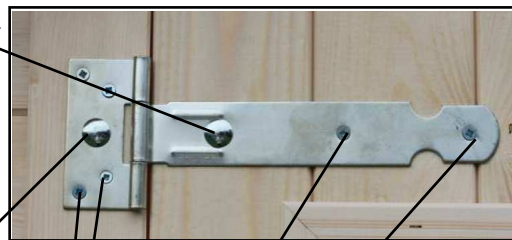
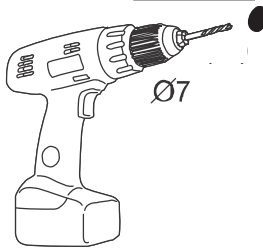
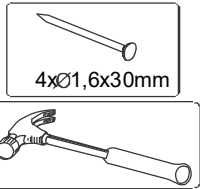
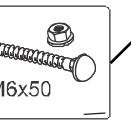
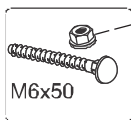
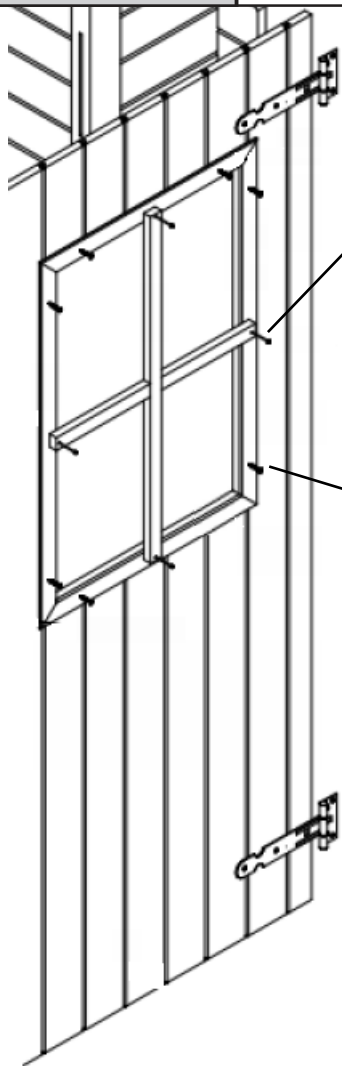
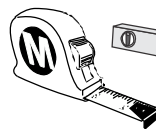
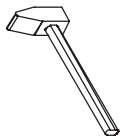

23

