

Bremen 40 (450x300)

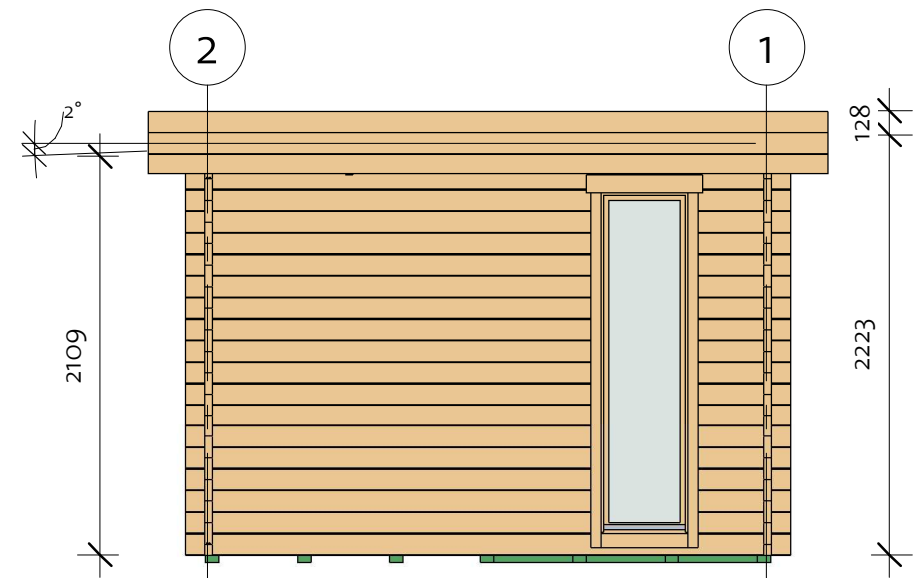

Bremen 40 (450x300)

Foundation

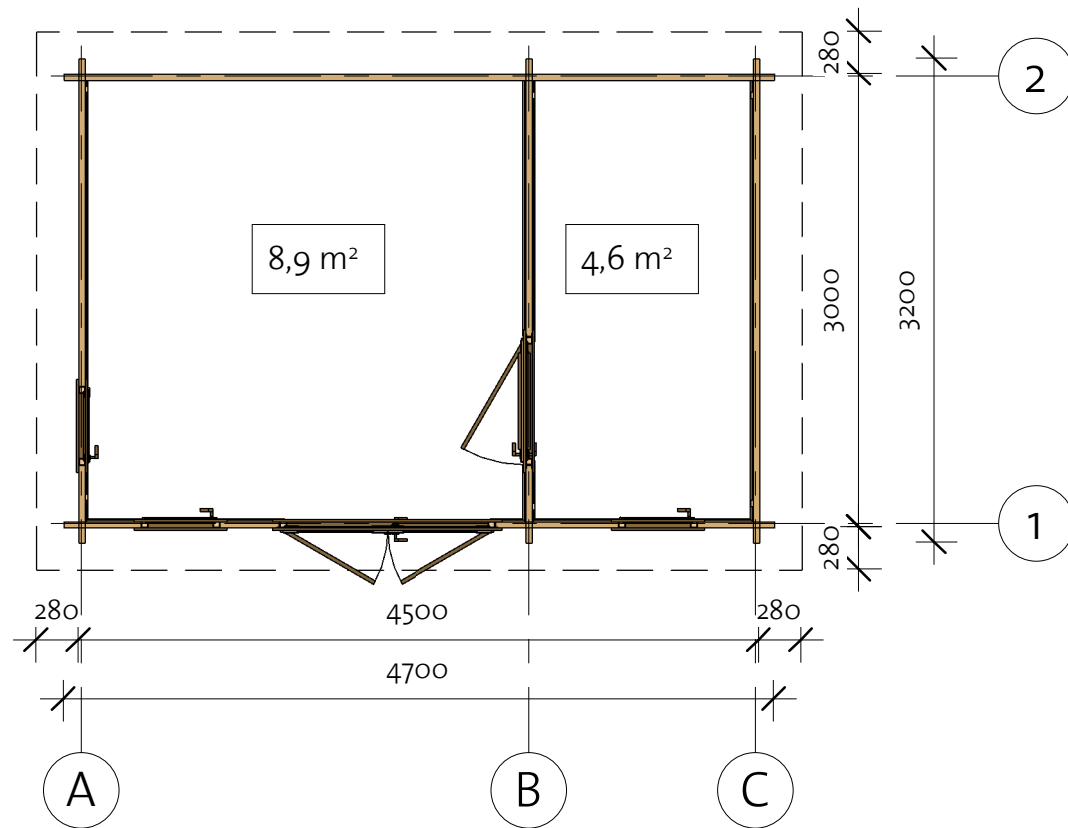
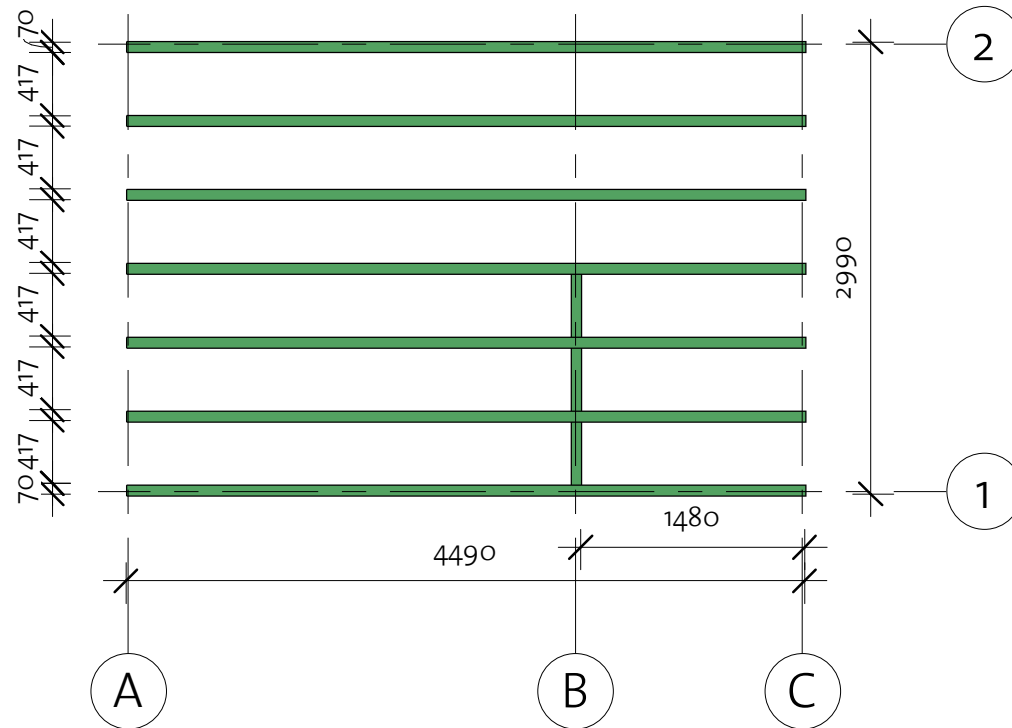

Impregnated foundation beams				
Mark	Type	Profile	Count	Length

IFB1	IFB 70x40		7	4490
IFB2	IFB 70x40		3	417



Bremen 40 (450x300)

Floor Plan

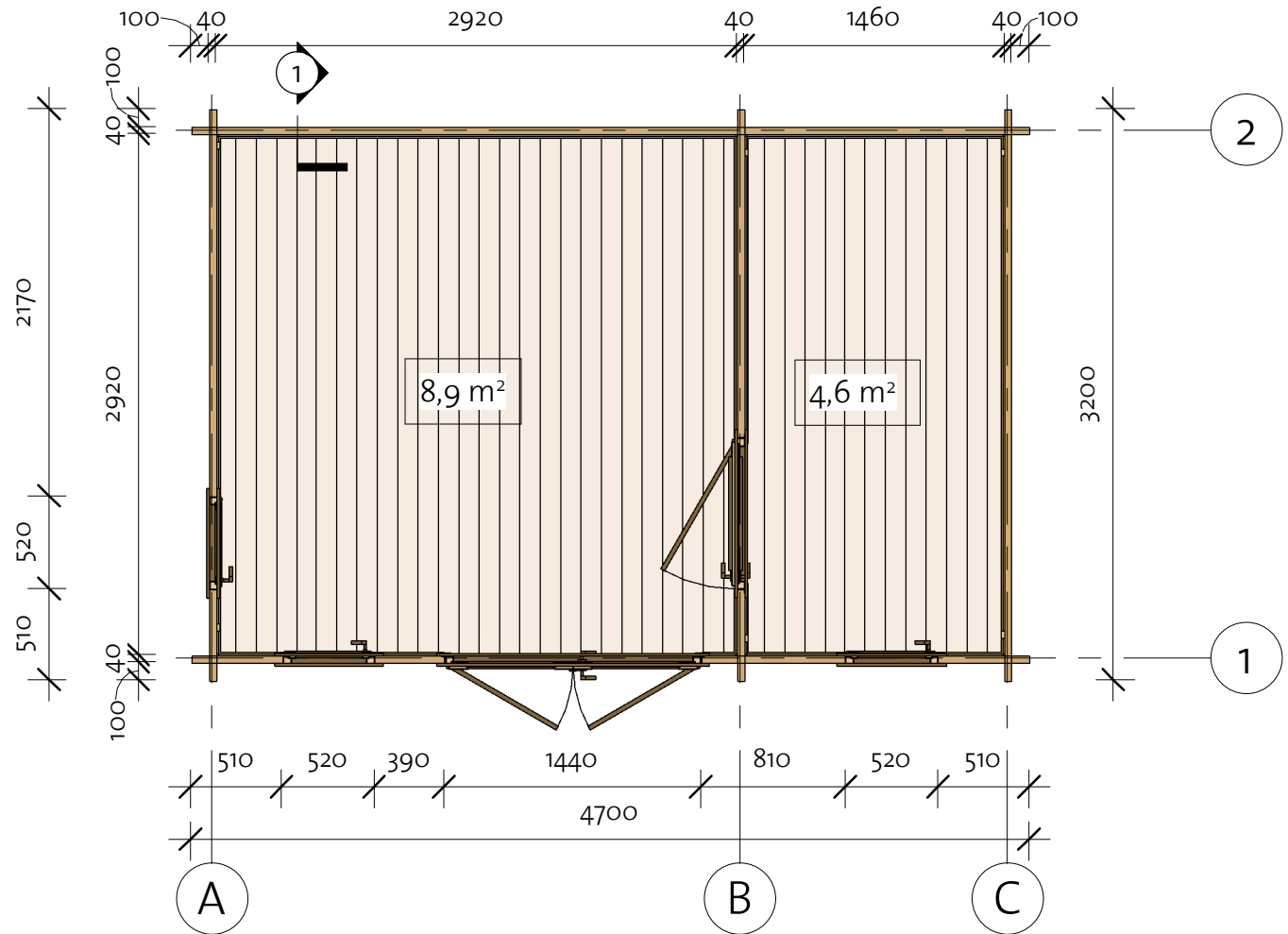
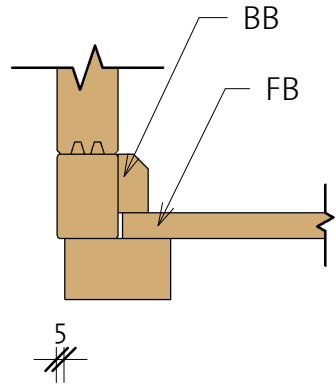
① Baseboard



Floor Schedule

Mark	Type	Profile	Count	Length
FB	FB 17x114		40	2914
BB1	BB 20x40		2	4500
BB2	BB 20x40		4	3000

91804244_230614

Bremen 40 (450x300)

Wall 1

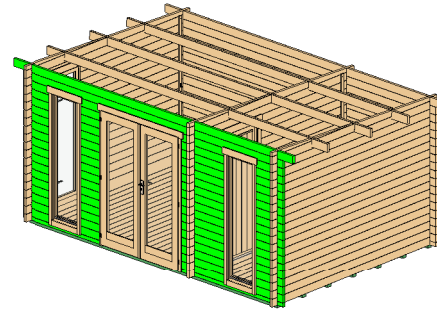

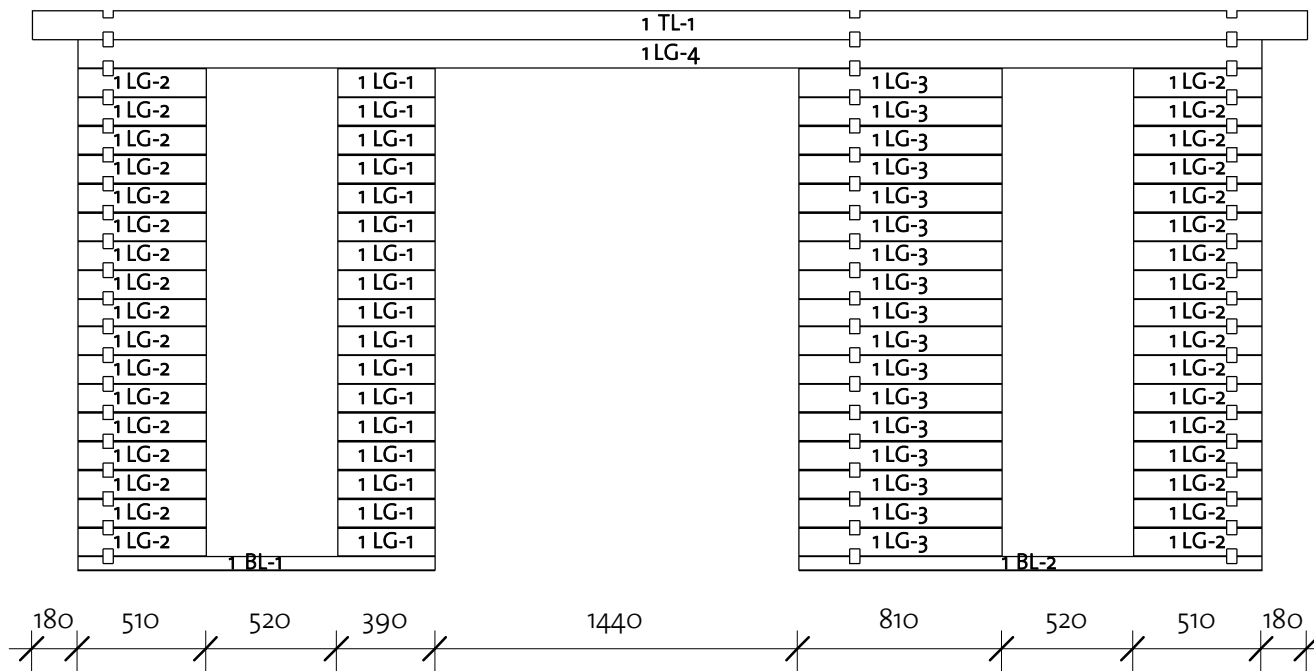

Wall 1			
Mark	Profile	Count	Cut Length

1BL-1	40x57	1	1420
1BL-2	40x57	1	1840
1LG-1	40x114	17	390
1LG-2	40x114	34	510
1LG-3	40x114	17	810
1LG-4	40x114	1	4700
1TL-1	40x114	1	5060



Log Profile Wall 1	
Profile	Profile

40x57	
40x114	
40x114	

Bremen 40 (450x300)

Wall 2

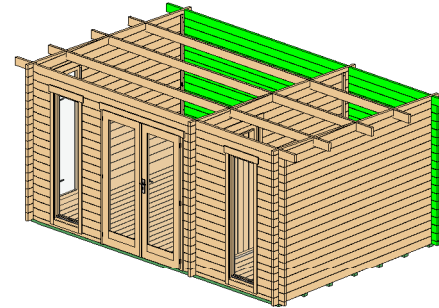

Wall 2			
Mark	Profile	Count	Cut Length
2BL-1	40x57	1	4700
2LG-1	40x114	17	4700
2TL-1	40x114	1	5060

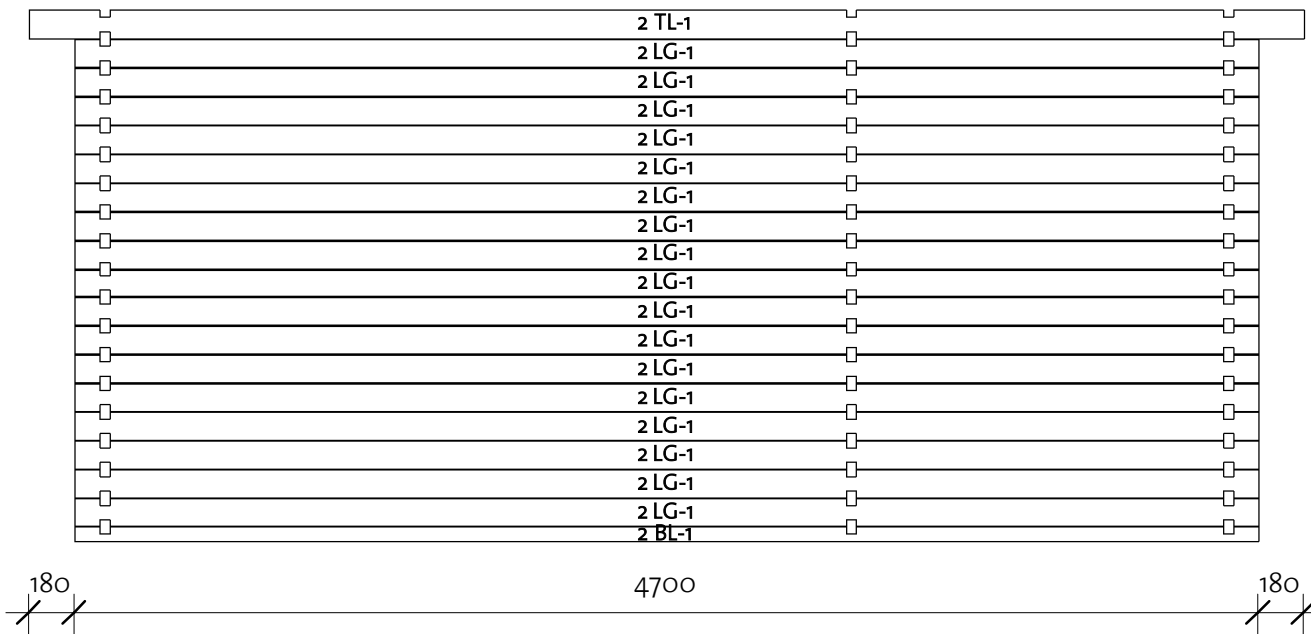

Log Profile Wall 2	
Profile	Profile
40x57	
40x114	
40x114	

Bremen 40 (450x300)

Wall A

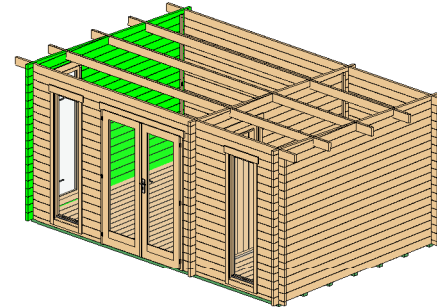

Wall A			
Mark	Profile	Count	Cut Length

ALG-1	40x114	16	510
ALG-2*	40x114	1	1580
ALG-3	40x114	16	2170
ALG-4*	40x114	1	3200
ALG-5*	40x114	1	3200
ALG-6	40x114	1	3200

* Gable - delivered premounted

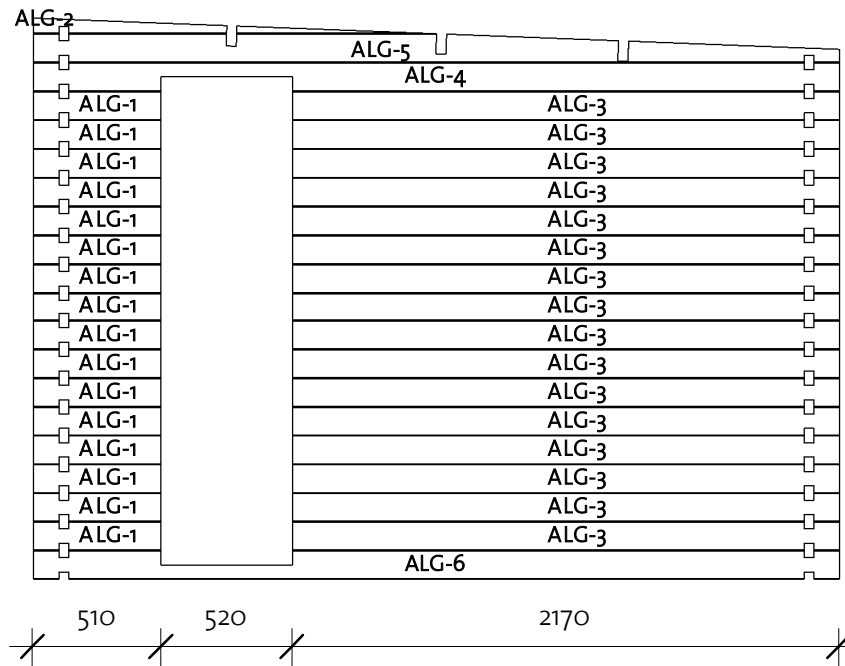

Log Profile Wall A	
Profile	Profile

40x114	
--------	--

Bremen 40 (450x300)

Wall B

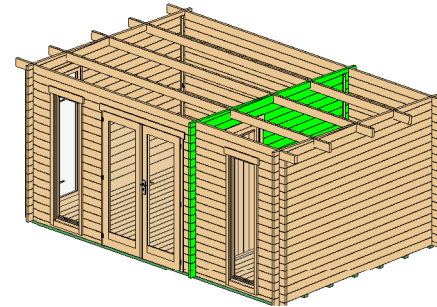

Wall B			
Mark	Profile	Count	Cut Length

BLG-1	40X114	17	510
BLG-2*	40X114	1	1580
BLG-3	40X114	17	1840
BLG-4*	40X114	1	3200
BLG-5*	40X114	1	3200

* Gable - delivered premounted

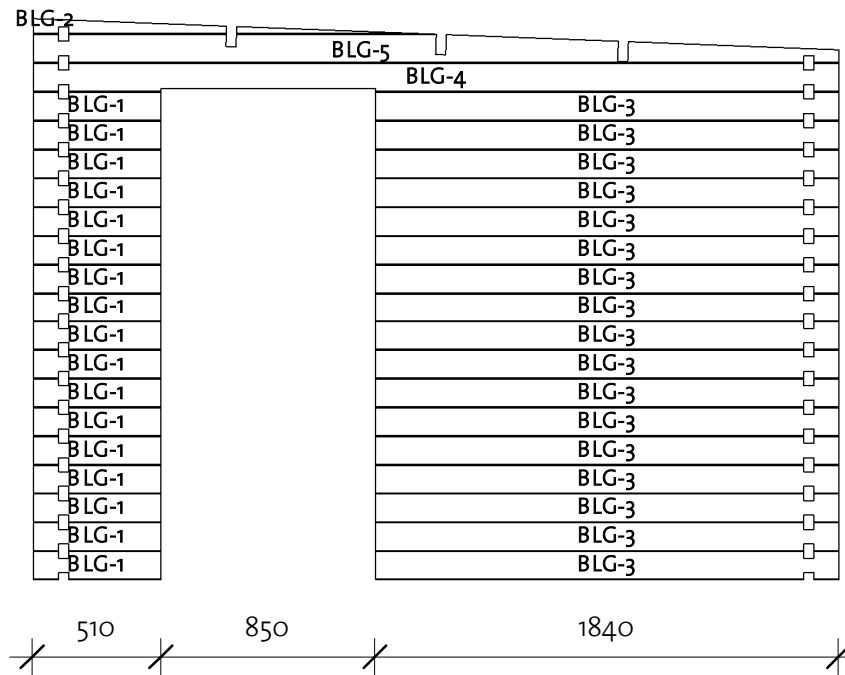

Log Profile Wall B	
Profile	Profile

40X114	
--------	--

Bremen 40 (450x300)

Wall C

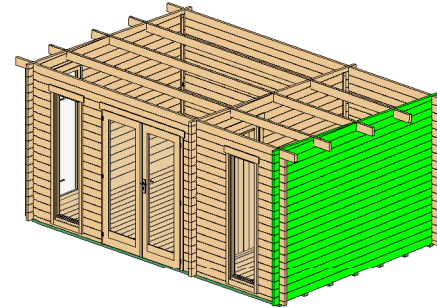

Wall C			
Mark	Profile	Count	Cut Length

CLG-1*	40x114	1	1580
CLG-2	40x114	17	3200
CLG-3*	40x114	1	3200
CLG-4*	40x114	1	3200

* Gable - delivered premounted

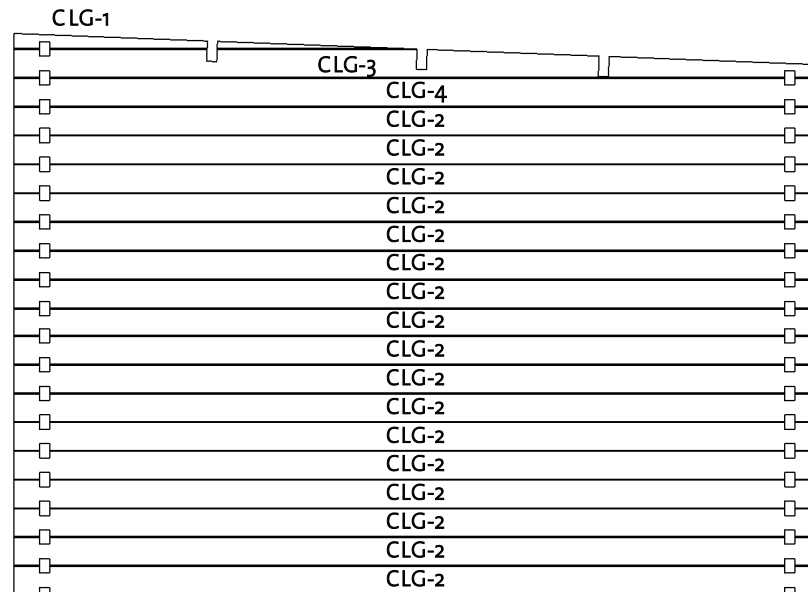



Log Profile Wall C	
Profile	Profile

40x114	
--------	--

Bremen 40 (450x300)

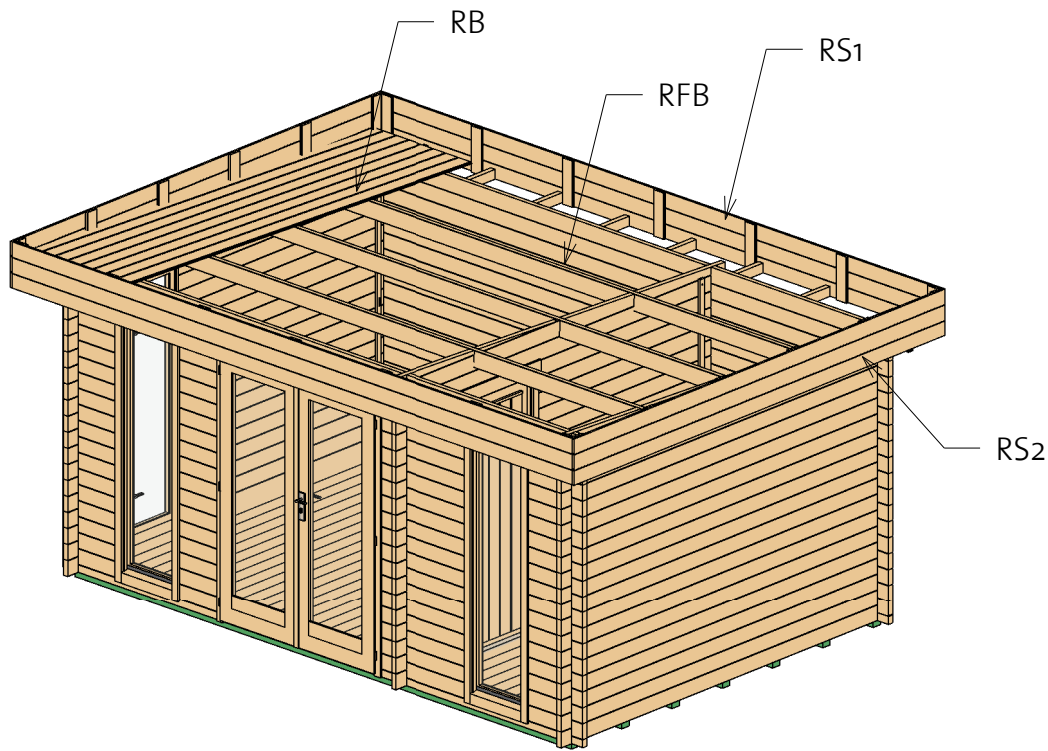
Roof 1

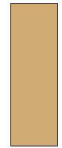

Roof				
Mark	Type	Profile	Count	Length
RB	17x114		45	3484
RC	40x70		16	280
RFB	Beam 40x120		3	5060

Roof Side Schedule		
Type	Length	Count
RS1	5060	2
RS2	3594	2

Bremen 40 (450x300)

Roof 2

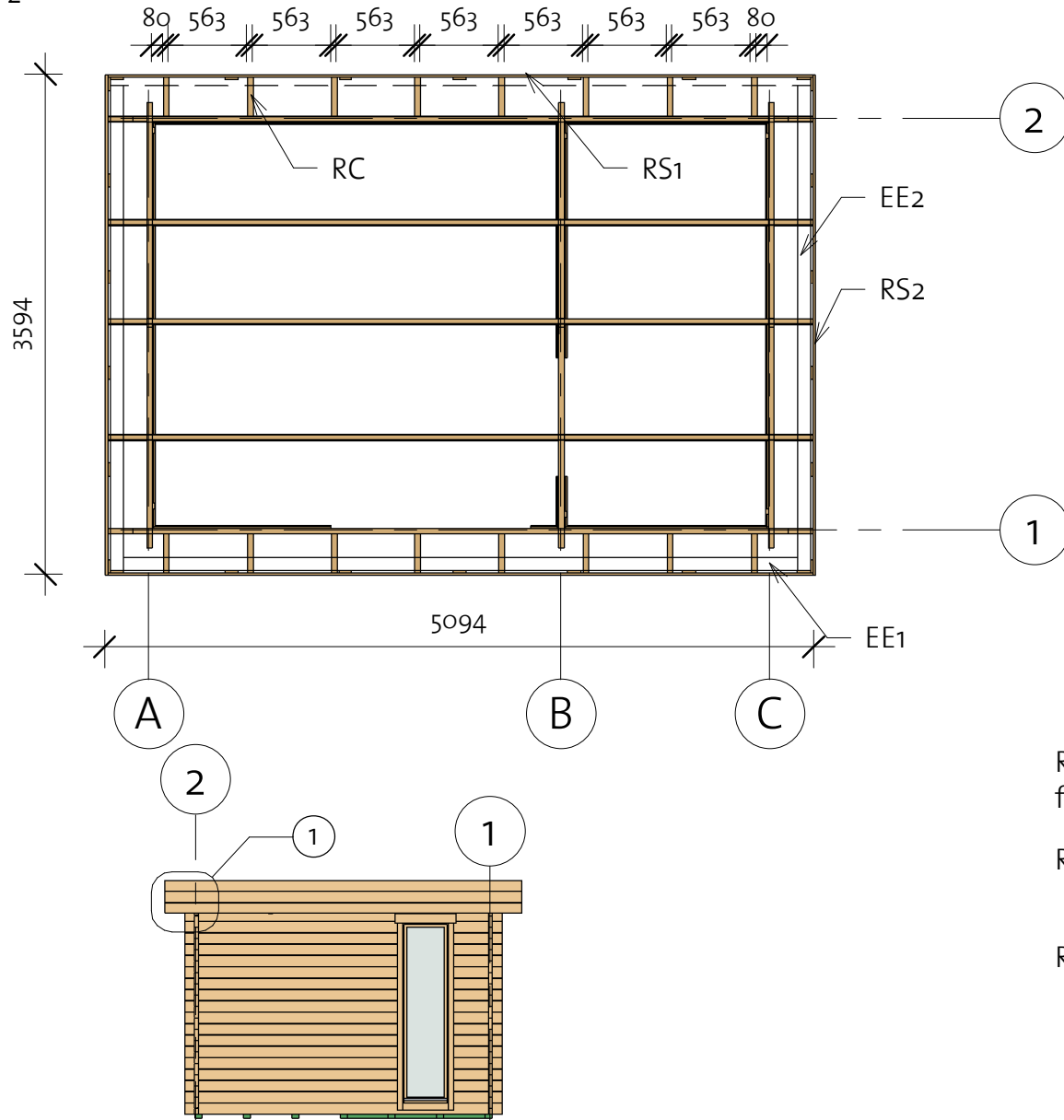

Fascia Schedule				
Mark	Type	Profile	Count	Length
EE1	Eave Edging 18x95		1	4835
EE2	Eave Edging 18x95		2	3485

① West Roof - Callout 1

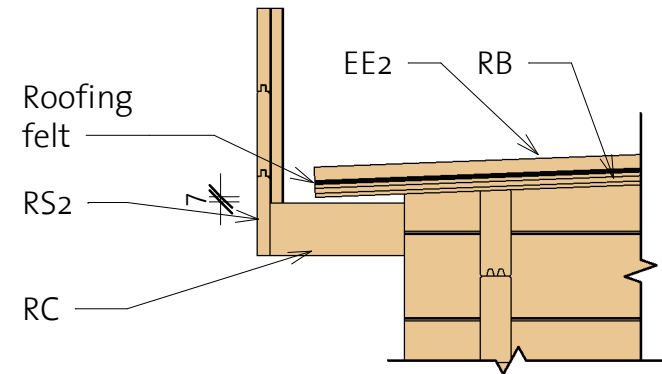

Bremen 40 (450x300)

Extras

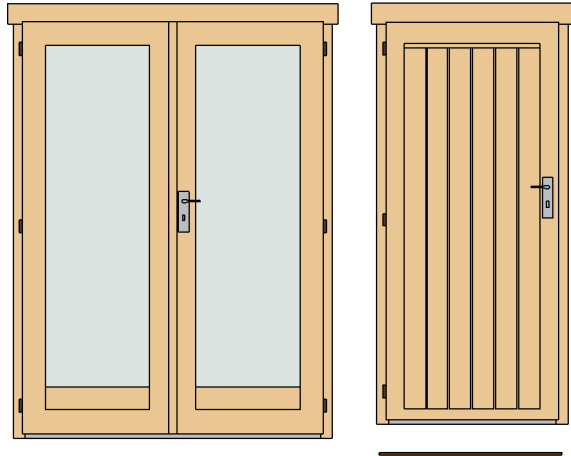

Door Schedule				
Model	Type	Width	Height	Count

CDD3R	Classic double door 3, full glass right	1425	1955	1
CD5L	Classic door 5, wood left	840	1890	1

DB	Door beam 850 mm	40	12	1
----	------------------	----	----	---

DCB8	Door Crossbar 8 optional	--	--	2
------	--------------------------	----	----	---

Window Schedule				
Mark	Type	Width	Height	Count

CW21R	Classic window 21 right	515	1890	3
-------	-------------------------	-----	------	---

WCB8	Windows Crossbar 8 optional	--	--	3
------	-----------------------------	----	----	---

Type	Count	Length
------	-------	--------

Windboard 18x40	6	2200
-----------------	---	------



Fasteners/Extras		
Name	Type	Count

Hitblock	300-400 mm	
Bolts	M8 x 70	12
Nails	1,4 x 40	50
Screws	5,0 x 70	55
Screws	6,0 x 140	60
Screws	4,0 x 40	670

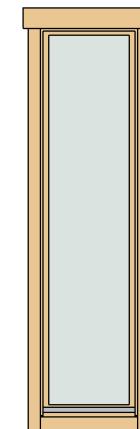



Bremen 40 (450x300)

List of all items 1

Impregnated foundation beams				
Mark	Type	Profile	Count	Length

IFB1	IFB 70x40		7	4490
IFB2	IFB 70x40		3	417

Roof				
Mark	Type	Profile	Count	Length

RB	17x114		45	3484
RC	40x70		16	280
RFB	Beam 40x120		3	5060

Roof Side Schedule		
Type	Length	Count

RS1	5060	2
RS2	3594	2

Floor Schedule				
Mark	Type	Profile	Count	Length

FB	FB 17x114		40	2914
----	-----------	---	----	------

BB1	BB 20x40		2	4500
BB2	BB 20x40		4	3000

Fascia Schedule				
Mark	Type	Profile	Count	Length

EE1	Eave Edging 18x95		1	4835
EE2	Eave Edging 18x95		2	3485

Bremen 40 (450x300)

List of all items 2

Wall 1			
Mark	Profile	Count	Cut Length

1BL-1	40x57	1	1420
1BL-2	40x57	1	1840
1LG-1	40x114	17	390
1LG-2	40x114	34	510
1LG-3	40x114	17	810
1LG-4	40x114	1	4700
1TL-1	40x114	1	5060

Wall A			
Mark	Profile	Count	Cut Length

ALG-1	40x114	16	510
ALG-2*	40x114	1	1580
ALG-3	40x114	16	2170
ALG-4*	40x114	1	3200
ALG-5*	40x114	1	3200
ALG-6	40x114	1	3200

Wall C			
Mark	Profile	Count	Cut Length

CLG-1*	40x114	1	1580
CLG-2	40x114	17	3200
CLG-3*	40x114	1	3200
CLG-4*	40x114	1	3200

Wall 2			
Mark	Profile	Count	Cut Length



2BL-1	40x57	1	4700
2LG-1	40x114	17	4700
2TL-1	40x114	1	5060

Wall B			
Mark	Profile	Count	Cut Length

BLG-1	40x114	17	510
BLG-2*	40x114	1	1580
BLG-3	40x114	17	1840
BLG-4*	40x114	1	3200
BLG-5*	40x114	1	3200

* Gable - delivered premounted

Log profiles	
Profile	Profile

40x57	
40x114	

Log profiles	
Profile	Profile

40x114	
--------	---

Windboard

① Windboard Assembly 1



② Windboard Assembly 2

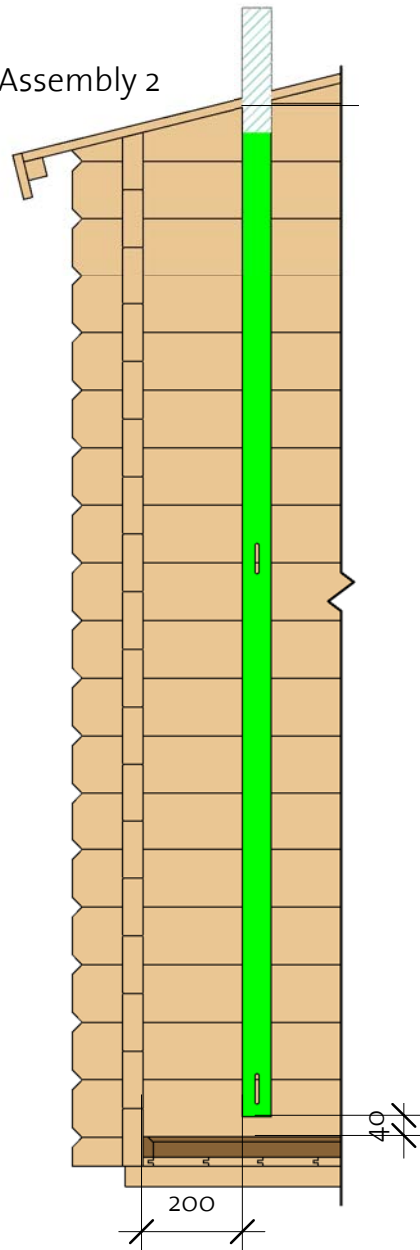

③ Windboard Assembly 3

